

Paradise Series

Owner's Manual



 CalderaSpas®
Pure Comfort

Moorea® • Hawaiian • Martinique® • Kauai®

WELCOME



Watkins Manufacturing Corporation congratulates you on your decision to enjoy the finest spa available... Welcome to the growing family of Caldera® Spa owners.

OWNER'S MANUAL

This Owner's Manual will acquaint you with the operation and general maintenance of your new spa. We suggest that you take some time to carefully review all sections. Please keep this manual available for reference.

If you have any questions about any aspect of your spa's set-up, operation or maintenance, contact your authorized Caldera dealership. They are trained professionals who are familiar with the product as well as new spa ownership concerns. Their expertise will facilitate the enjoyment of your new Caldera spa.

The serial number/identification label is located within the equipment compartment of your Caldera spa. The serial number should also be documented on the delivery receipt from your dealer.

IMPORTANT: Watkins Manufacturing Corporation reserves the right to change specifications, or design, without notification and without incurring any obligation.

DATE PURCHASED: _____

DATE INSTALLED: _____

DEALER: _____

ADDRESS: _____

TELEPHONE: _____

SPA MODEL/SERIAL NUMBER: _____

COVER SERIAL NUMBER: _____



MODEL: MARTINIQUE
SERIES: PARADISE
SERIAL: MAA1L1001
RATINGS: 240V, 60Hz, 40A



LISTED SELF CONTAINED SPA
1280 Park Center Dr., Vista, CA 92081
Watkins Manufacturing Corp.

MAA1L1001



In most cities and counties, permits will be required for the installation of electrical circuits or the construction of exterior surfaces (decks and gazebos). In addition, some communities have adopted residential barrier codes which may require fencing and/or self-closing gates on the property to prevent unsupervised access to a pool (or spa) by children under 5 years of age. Your Caldera spa is equipped with a locking cover that meets the ASTM F1346-91 Standard for Safety Covers, and as a result, is usually exempt from most barrier requirements. As a general practice, your local Building Department will inform you of any applicable barrier requirements at the time a permit is obtained for the installation of an electrical circuit. Your Caldera dealer can provide information on which permits may be required.

TABLE OF CONTENTS

SAFETY INFORMATION

- Important Safety Instructions 2
- Important Spa Instructions 4

INSTALLATION

- Site Preparation 4
- Outdoor and Patio Installation 4
- Deck Installation 5
- Indoor/Basement Installation 5
- Spa Leveling Preparation 5
- Spa Cover Installation 5

CONTROLS AND EQUIPMENT

- Paradise Moorea® 6
- Paradise Hawaiian 7
- Paradise Martinique® 8
- Paradise Kauai® 9

ELECTRICAL INSTALLATION

- Electrical Requirements and Precautions 10
- 230 Volt Permanently Connected 10

START-UP AND REFILL PROCEDURES 12

CUSTOMIZING YOUR MASSAGE

- Diverter Valves 13
- Air Controls 13
- Hydro Jets 13
- Air Jets 14

JET MENU

- Paradise Moorea Jet Menu 15
- Paradise Hawaiian Jet Menu 16
- Paradise Martinique Jet Menu 17
- Paradise Kauai Jet Menu 18

OPERATING INSTRUCTIONS

- Locking Features 19
- Main Control Panel Buttons and Display 20

EQUIPMENT COMPARTMENT

- Jet Pump Side 22
- Controls Side 23

MAINTENANCE

- Filter Maintenance 24
- Filter Cartridge Removal and Cleaning Instructions 24
- Diverter Valve Maintenance 24
- VersaSage® Jets Maintenance 24
- Draining Your Spa 25
- Winterizing Your Spa 25
- Care of the Spa Pillows 26
- Care of the Exterior 26
- Care of the Spa Cover 27

WATER QUALITY AND MAINTENANCE

- Water Terminology 28
- General Information 28
- Methods for Testing the Spa Water 29
- The Watkins Spa Water Maintenance Program 29
- SPA FROG® Water Care System 31
- Bromine 32
- Supplemental Water Maintenance 33
- Common Water Chemistry Questions 35
- Spa Water Maintenance Troubleshooting Guide 35

SERVICE

- Miscellaneous Service Information 36
- Acts Invalidating Warranty 36
- Disclaimers 36
- Watkins Customer Service 36

SPA TROUBLESHOOTING

- General Operation Troubleshooting Guide 37

WARRANTY

- Comfort Guard® 38

SPA SPECIFICATIONS Back Cover

SAFETY INFORMATION

IMPORTANT SAFETY INSTRUCTIONS

READ AND FOLLOW ALL INSTRUCTIONS

AVOIDING THE RISK TO CHILDREN

DANGER:

RISK OF CHILD DROWNING. Extreme caution must be exercised to prevent unauthorized access by children. To avoid accidents, ensure that children cannot use a spa unless they are supervised at all times.

WARNING:

- To reduce the risk of injury, do not permit children to use this spa unless they are closely supervised at all times.
- To reduce the risk of injury, lower water temperatures are recommended for young children. Children are especially sensitive to hot water.

DO:

- Make sure you always lock the child resistant locks after using the spa for your children's safety. Every Caldera® spa is equipped with a locking cover that meets the ASTM F1346-91 Standard for Safety Covers.
- Test the water temperature with your hand before allowing children to enter the spa to be sure that it's comfortable. Children are especially sensitive to hot water.
- Remind children that wet surfaces can be very slippery. Make sure that children are careful when entering, or exiting the spa.

DON'T:

- Allow children to climb onto the spa cover.
- Allow children to have unsupervised access to the spa.

AVOIDING THE RISK OF ELECTROCUTION

RISK OF ELECTROCUTION

- Connect only to a grounded source.
- Do not bury the power cord. A buried power cord may result in death, or serious personal injury due to electrocution if direct burial-type cable is not used, or if improper digging occurs.
- A ground terminal (pressure wire connector) is provided on the control box inside the unit to permit connection of a minimum No. 10 AWG solid copper bonding conductor between this point and any metal equipment, metal water pipe, metal enclosures of electrical equipment, or conduit within five feet (1.5 m) of the unit as needed to comply with local requirements.

WARNING:

- To reduce the risk of electrical shock, replace a damaged cord immediately. Failure to do so may result in death or serious personal injury due to electrocution.
- Your spa is provided with a Ground Fault Circuit Interrupter for user and equipment protection. To ensure proper operation of this important safety device, test according to the following instructions per electrical configuration.

230 volt, permanently installed models:

- A ground terminal is provided on the terminal block located inside the control box. To reduce the risk of electric shock, connect this terminal to the grounding terminal of your electrical service or supply panel with a continuous green, insulated copper wire. The wire must be equivalent in size to the circuit conductors supplying the equipment. In addition, a bonding terminal (pressure wire connector) is provided on the outside of the control box for bonding to local ground points. To reduce the risk of electric shock, this connector should be bonded with a No. 10 AWG solid copper wire to any metal ladders, water pipes, or other metal within 5 feet (1.5 m) of the spa to comply with local requirements. The means of disconnection must be readily accessible, but must be installed at least 5 feet (1.5 m) from the spa.
- Your spa is provided with a suitably rated circuit breaker to open all ungrounded supply conductors.
- Your spa uses ground fault circuit interrupters in the electrical subpanel. Before each use of the spa and with the unit operating, push the TEST button on each breaker. The switch should click over to the "Trip" position. Wait 30 seconds and reset each GFCI breaker by switching it completely off and then completely on. The switch should then stay on. If either of the interrupters does not perform in this manner, it is an indication of an electrical malfunction and the possibility of an electric shock. Disconnect the power until the fault has been identified and corrected.

DANGER: RISK OF ELECTRICAL SHOCK

- Install spa at least 5 feet (1.5 m) from all metal surfaces. A spa may be installed within 5 feet of a metal surface if each metal surface is permanently connected by a minimum No. 8 AWG solid copper conductor attached to the wire ground connector on the terminal box that is provided for this purpose if in accordance with National Electrical Code ANSI/NMFA70-1993.
- Do not permit any electrical appliances, such as a light, telephone, radio, or television within 5 feet (1.5 m) of a spa. Failure to maintain a safe distance may result in death, or serious personal injury due to electrocution, if the appliance should fall into the spa.

SAFETY INFORMATION

- Install your spa in such a way that drainage is away from the electrical compartment and from all electrical components.

DO:

- Be sure your spa is connected to the power supply correctly - use a licensed electrical contractor.
- Disconnect the spa from the power supply before draining the spa or servicing the electrical components.
- Test the Ground Fault Circuit Interrupter(s) before each use.

DON'T:

- Use the spa with the equipment compartment door removed.
- Place electrical appliances within 5 feet (1.5m) of the spa.
- Use an extension cord to connect the spa to its power source. The cord may not be properly grounded and the connection is a shock hazard. An extension cord may cause a voltage drop, which will cause overheating of the jet pump motor and motor damage.
- Attempt to open the electrical control box. There are no user serviceable parts inside.

RISKS TO AVOID

⚠ DANGER: RISK OF INJURY

- To reduce the risk of injury to persons, DO NOT remove floating weir, basket and filter located in the filter compartment while the spa is running.
- Never replace a suction fitting with one rated less than the flow rate marked on the original suction fitting.
- There is a danger of slipping and falling. Remember that wet surfaces can be very slippery. Take care when entering or exiting the spa.
- Never operate spa if the suction fittings are broken or missing.
- People with infectious diseases should not use the spa.
- Keep any loose articles of clothing or hanging jewelry away from rotating jets or other moving components.

INCREASED SIDE EFFECTS OF MEDICATION

- The use of drugs, alcohol or medication before or during spa use may lead to unconsciousness with the possibility of drowning.
- Persons using medications should consult a physician before using a spa; some medication may cause a user to become drowsy, while other medication may affect heart rate, blood pressure, and circulation.
- Persons taking medications which induce drowsiness, such as tranquilizers, antihistamines, or anticoagulants should not use the spa.

HEALTH PROBLEMS AFFECTED BY SPA USE

- Pregnant women should consult a physician before using spa.
- Persons suffering from obesity, or with a medical history of heart disease, low or high blood pressure, circulatory system problems, or diabetes should consult a physician before using spa.

UNCLEAN WATER

- Keep the water clean and sanitized with correct chemical care. The recommended levels for your Caldera® spa are:

Bromine:	1.0 - 2.0 ppm with SPA FROG® (3-5 ppm if not using SPA FROG)
Water pH:	7.2 - 7.8
Total Alkalinity:	80 - 180 ppm
Calcium Hardness:	150 - 400 ppm

(Refer to Water Quality and Maintenance section for complete instructions.)

IMPORTANT: Turn on the clean cycle when adding any spa water chemicals into the filter compartment.

- Clean the filter cartridge at least monthly to remove debris and mineral buildup which may affect the performance of the hydromassage jets, limit the flow, or trip the high limit thermostat, which will turn off the entire spa.

AVOIDING THE RISK OF HYPERTHERMIA

Prolonged immersion in hot water can result in HYPERTHERMIA, a dangerous condition which occurs when the internal temperature of the body reaches a level above normal (98.6°F). The symptoms of hyperthermia include unawareness of impending hazard, failure to perceive heat, failure to recognize the need to exit the spa, physical inability to exit the spa, fetal damage in pregnant women, and unconsciousness resulting in a danger of drowning.

⚠ WARNING:

The use of alcohol, drugs, or medication can greatly increase the risk of fatal hyperthermia in hot tubs and spas.

TO REDUCE THE RISK OF INJURY:

- The water in the spa should never exceed 104°F (40°C). Water temperatures between 100°F (38°C) and 104°F (40°C) are considered safe for a healthy adult. Lower water temperatures are recommended for extended use (exceeding ten minutes) and for young children. Extended use can cause hyperthermia.

SAFETY INFORMATION

- Pregnant or possibly pregnant women should limit spa water temperatures to 100°F (38°C). Failure to do so may result in permanent injury to your baby.
- Do not use spa immediately following strenuous exercise.

AVOIDING THE RISK OF SKIN BURNS:

- To reduce the risk of injury, before entering a spa, the user should measure the water temperature since the tolerance of temperature-regulating devices varies.
- Test the water with your hand before entering the spa to be sure it's comfortable.

SAFETY SIGN

Each Caldera® spa is shipped with a SAFETY SIGN in the owner's package. The sign, which is required as a condition of Product Listing, should be permanently installed where it is visible to the users of the spa. To obtain additional SAFETY SIGNS, contact your Caldera dealer and request Part #003021

IMPORTANT SPA INSTRUCTIONS

The following contains important spa information, and we strongly encourage you to read and apply them.

DO:

- Use and lock the cover when the spa is not in use, whether it is empty or full.
- Follow the Spa Care and Maintenance recommendations stated in this manual.
- Use only approved accessories and recommended spa chemicals and cleaners.

DON'T:

- Leave the Caldera spa exposed to the sun without water or the cover in place. Exposure to direct sunlight can cause solar distress of the shell material.
- Roll or slide the spa on its side. This will damage the siding.
- Lift or drag the vinyl cover by using the cover lock straps; always lift or carry the cover by using the handles.
- Attempt to open the electrical control box. There are no user serviceable parts inside. Opening of the control box by the spa owner will void the warranty. If you have an operational problem, carefully go through the steps outlined in the Troubleshooting section. If you are not able to resolve the problem, contact your authorized Caldera dealer. Many problems can easily be diagnosed over the telephone by an Authorized Service Technician.

SAVE THESE INSTRUCTIONS

INSTALLATION

SITE PREPARATION

You probably have a spot picked out for your new spa, whether it's indoors or outdoors, on a patio or on a deck. Just make sure you check the following:

- Always put your spa on a structurally sound, level surface. A filled spa can weigh a great deal. Make certain that the location you choose can support the weight of your filled spa.
- Don't forget to level your spa before filling it. (See the Spa Leveling Preparation section on next page.)
- Locate your equipment compartment, which houses all of the electrical components, in a place where water will drain away from it. Allowing water into the equipment compartment can damage the electronics, or may result in tripping your house's circuit breaker.
- Leave yourself easy access to the circuit breakers in the subpanel.
- Never let water get into the subpanel. Your 230 volt spa's subpanel is rain-tight when installed correctly with the door closed. Periodically check these conditions and correct any flaws if detected.
- Leave access to the equipment compartment for periodic spa care and maintenance.

⚠ **WARNING: Damage to the spa's equipment compartment components or internal plumbing as a result of rodent infestation is NOT covered under your warranty!**

OUTDOOR AND PATIO INSTALLATION

No matter where you install your new spa, it's important that you have a solid foundation to support it. Structural damage to the spa, resulting from incorrect installation, or placement on an inadequate foundation, is not covered under the spa's limited warranty.

If you install the spa outdoors, we recommend a reinforced concrete pad at least four inches thick. The reinforcing rod or mesh in the pad should be attached to a bond wire.

INSTALLATION

DECK INSTALLATION

To be certain your deck can support your spa, you must know the deck's maximum load capacity. Consult a qualified building contractor or structural engineer. To find the weight of your spa, its contents and occupants, refer to the Spa Specification chart on back cover. This weight per square foot must not exceed the structure's rated capacity, or serious structural damage could result.

INDOOR/BASEMENT INSTALLATION

Be aware of some special requirements if you place your spa indoors. Water will accumulate around the spa, so flooring materials must provide a good grip when wet. Proper drainage is essential to prevent a build-up of water around the spa. When building a new room for the spa it is recommended that a floor drain be installed. The humidity will naturally increase with the spa indoors. Water may get into woodwork and produce dry rot, mildew, or other problems. Check for airborne moisture's effects on exposed wood, paper, etc. in the room. To minimize these effects, it is best to provide plenty of ventilation to the spa area. An architect can help to determine if more ventilation must be installed.

Caldera spas are equipped with a jet pump shroud to remove excessive heat from the equipment compartment. Find this vent and be sure the vent is not blocked by anything, including carpeting.

Your Caldera dealer can help you with local information such as zoning regulations and building codes.

⚠ WARNING: Please keep the area around your spa well ventilated when it is installed indoors or in a confined area.

Inadequate ventilation around the spa could cause a build-up of a higher-than-normal concentration of spa chemicals and/or bacterial fragments. These dispersed spa chemicals and/or bacterial fragments can be inhaled, and may result in breathing difficulties or lung damage in certain people suffering from a compromised immune system or respiratory infection. If you or other bathers are affected by this condition, please seek medical attention as soon as possible.

In addition to the above, properly clean and maintain your spa as follows:

- Follow all procedures in this owner's manual and printed instructions on all water care (chemical) products packaging.
- Test the water regularly to ensure proper levels of sanitizers, pH, and other water care requirements.
- Drain, clean, and refill your spa with fresh water on a regular schedule, and in accordance with this owner's manual.
- Clean the filter(s) at least once per month.
- Check to make sure you have proper circulation throughout your spa water system.
- Have spa users bathe before entering the spa water.

SPA LEVELING PREPARATION

Concrete sloped at 1/2 inch (1.3 cm) per 10 feet (305 cm) is preferred so that rain water and water spillover will run off and not puddle underneath the spa (water under the spa for long periods of time may cause the wood to deteriorate). Other options are brick, stepping stone, or blocks.

It is important to note that soft surfaces, even when stepping stones are used to evenly distribute the weight of the spa, will have a tendency to settle, thus resulting in an unlevelled spa.

NOTE: Placing the spa on grass or dirt may increase the amount of debris which is inadvertently brought into the spa water and may cause harm to your equipment as well as the spa surface, which is not covered under warranty.

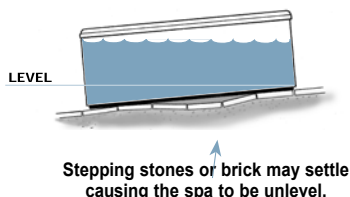
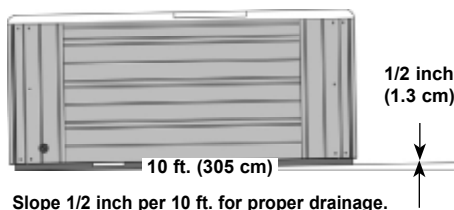

SPA COVER INSTALLATION

- Place the cover squarely on the spa.
- Position the tie-down locks included with your cover on the side of the spa so that they are easily reached by the cover tie-down straps. Allow for about 1/2" to 3/4" slack in the straps to make it easy to insert straps into locks and to compensate for vinyl shrinkage in cold weather.
- Attach the locks with the screws provided and insert the cover tie-down straps into the locks.

NOTE: Keeping the cover in place any time the spa is not in use will reduce the amount of time the heater operates, thereby minimizing operating costs.

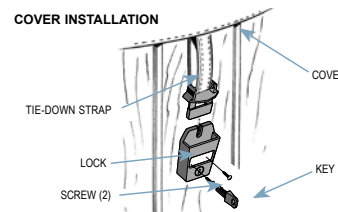

DANGER. RISK OF INJURY.

- Never leave a spa uncovered or unattended.
- Never leave a spa cover unlocked.
- Do not stand, sit, or lie on the cover.

CONTROLS AND EQUIPMENT

PARADISE MOOREA®

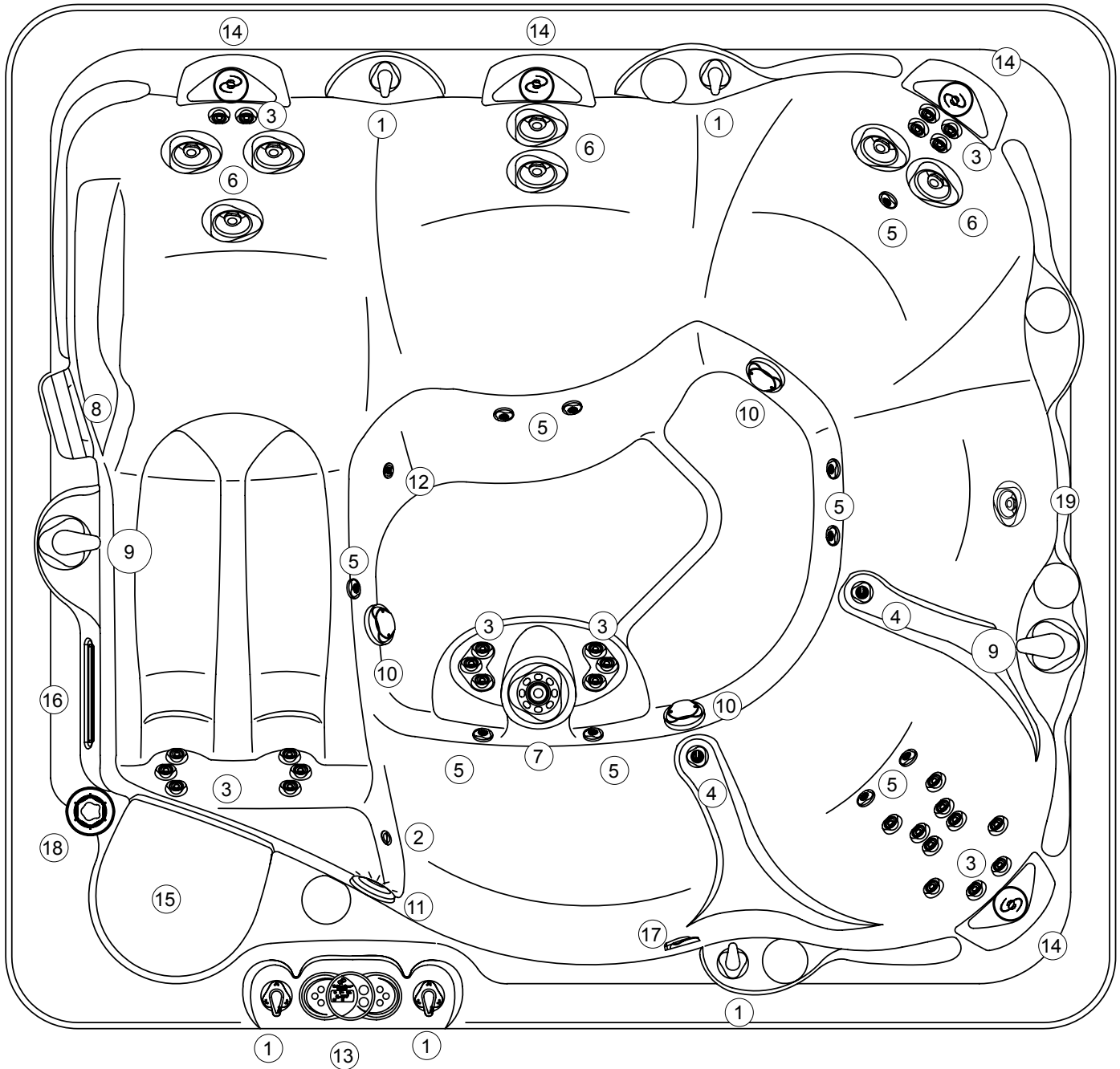

OVERHEAD VIEW

- | | | | |
|-------------------------|-------------------|------------------------|-----------------------|
| 1. Air Control Valve | 6. VersaSage® Jet | 11. Light | 16. Water Fall |
| 2. Temperature Sensor | 7. Euphoria® Jet | 12. Ozone Jet | 17. Water Fall Valve |
| 3. Euro Directional Jet | 8. Assist Bar | 13. Control Panel | 18. SPA FROG® Housing |
| 4. Euro-Pulse® Jet | 9. Diverter Valve | 14. Pillow | 19. AdaptaFlo™ Jet |
| 5. Air Jet | 10. Drain | 15. Filter Compartment | |

CONTROLS AND EQUIPMENT

PARADISE HAWAIIAN

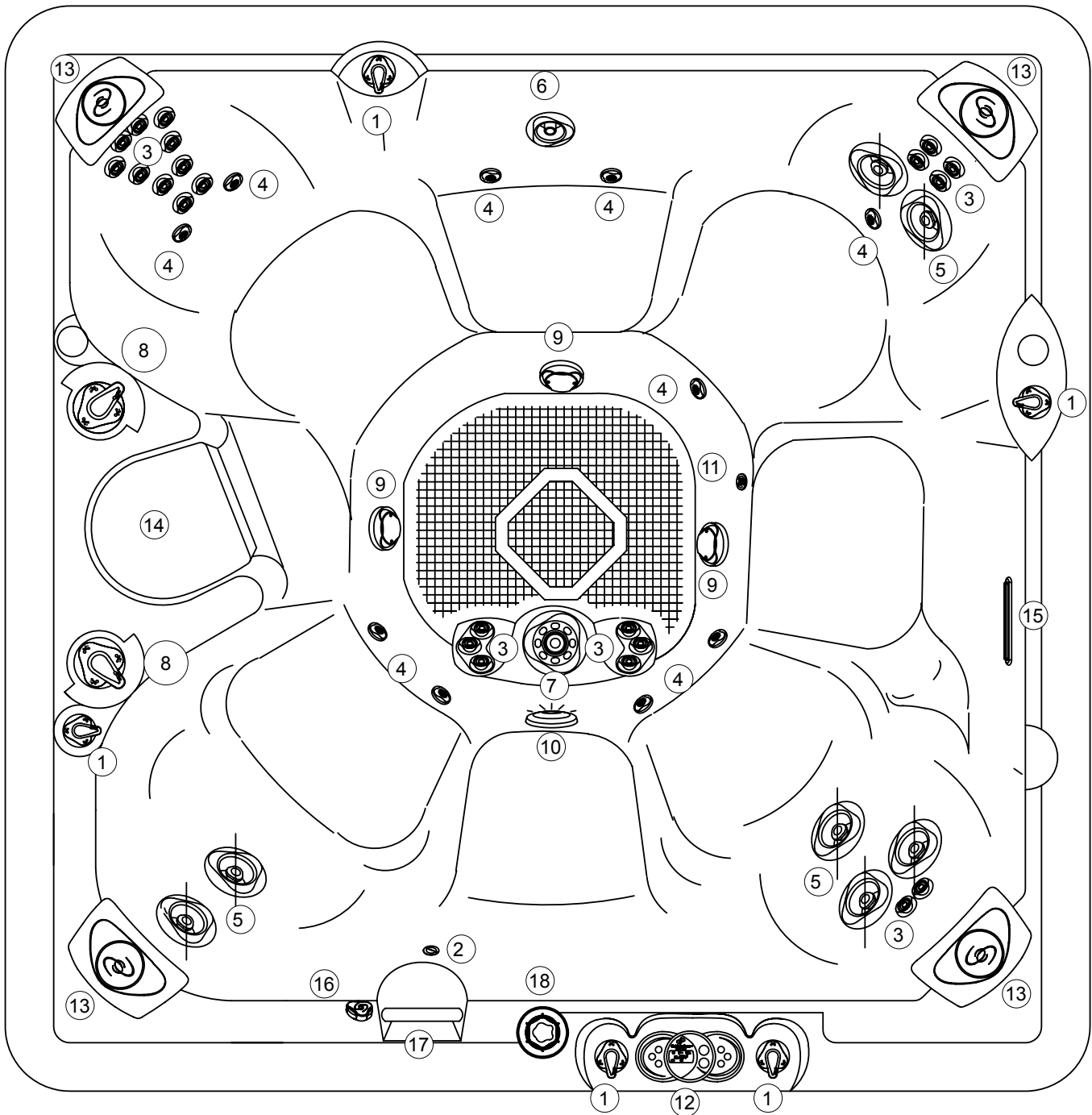

OVERHEAD VIEW

- | | | | | |
|-------------------------|-------------------|-------------------|------------------------|-----------------------|
| 1. Air Control Valve | 5. VersaSage® Jet | 9. Drain | 13. Pillow | 17. Assist Bar |
| 2. Temperature Sensor | 6. AdaptaFlo™ Jet | 10. Light | 14. Filter Compartment | 18. SPA FROG® Housing |
| 3. Euro Directional Jet | 7. Euphoria® Jet | 11. Ozone Jet | 15. Waterfall | |
| 4. Air Jet | 8. Diverter Valve | 12. Control Panel | 16. Waterfall Valve | |

CONTROLS AND EQUIPMENT

PARADISE MARTINIQUE®

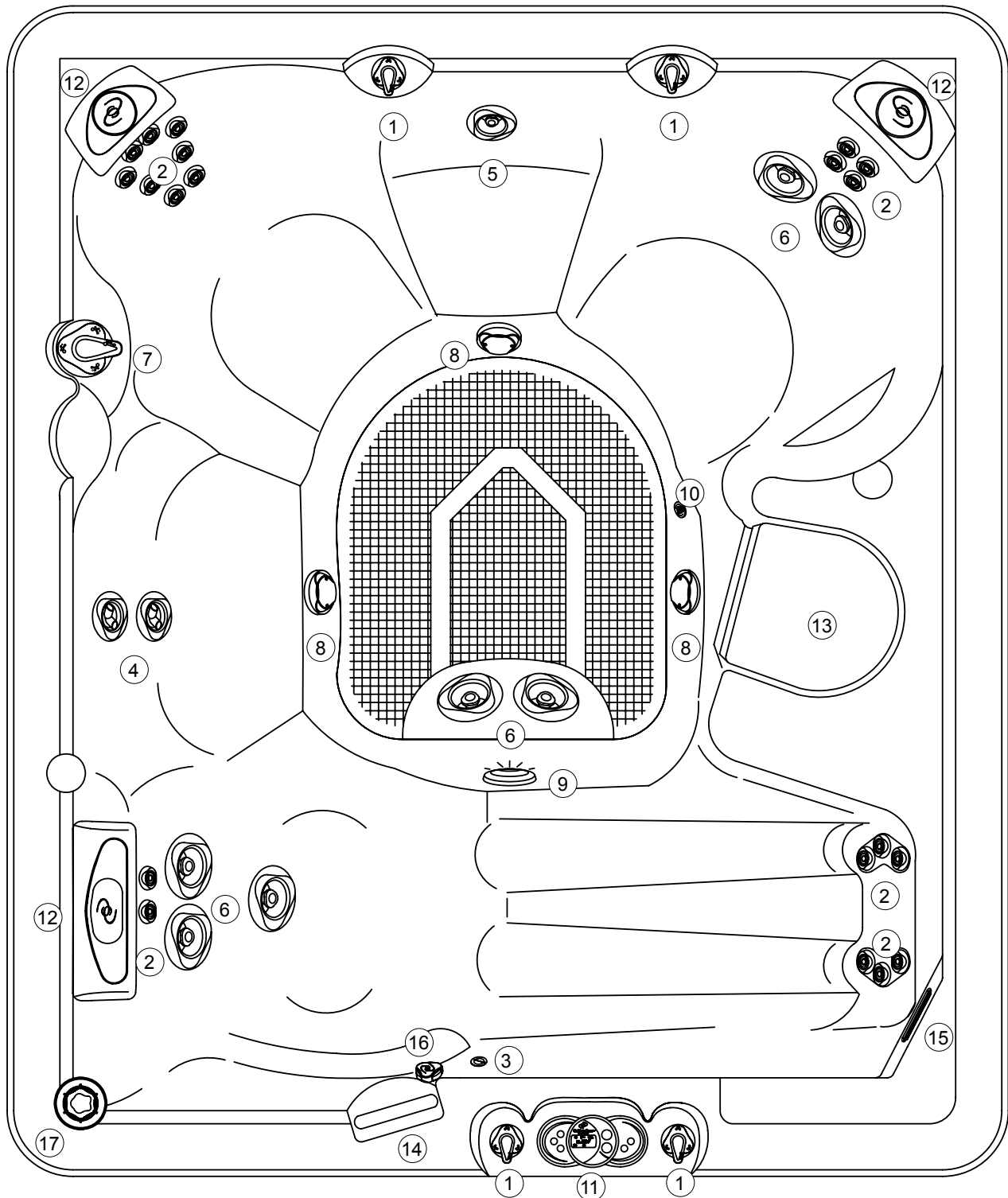

OVERHEAD VIEW

- | | | | | |
|-------------------------|--------------------|-------------------|------------------------|-----------------------|
| 1. Air Control Valve | 5. AdaptaFlo™ Jet | 9. Light | 13. Filter Compartment | 17. SPA FROG® Housing |
| 2. Euro Directional Jet | 6. VersaSsage® Jet | 10. Ozone Jet | 14. Assist Bar | |
| 3. Temperature Sensor | 7. Diverter Valve | 11. Control Panel | 15. Waterfall | |
| 4. AdaptaSsage™ Jet | 8. Drain | 12. Pillow | 16. Waterfall Valve | |

CONTROLS AND EQUIPMENT

PARADISE KAUAI®

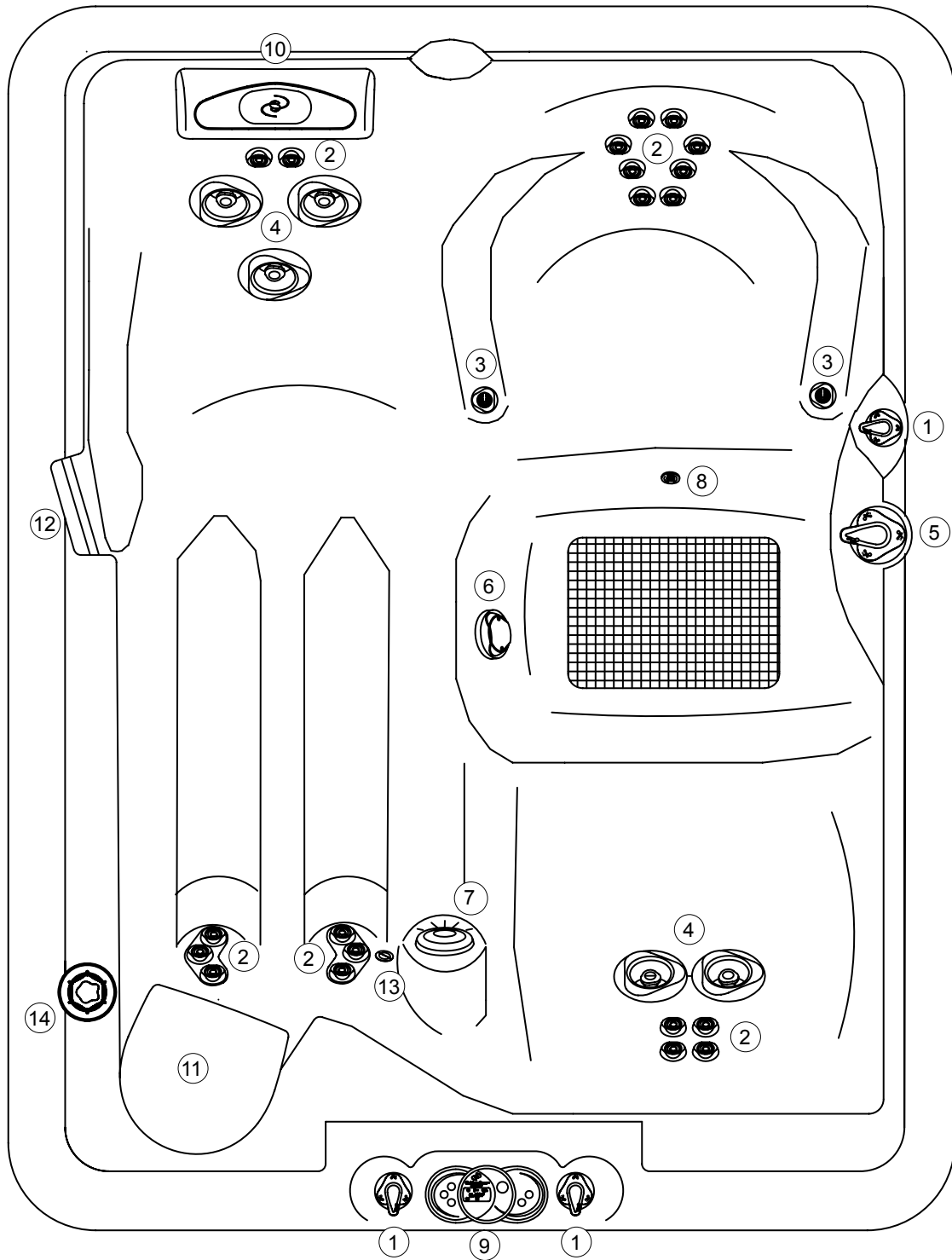

OVERHEAD VIEW

- | | | | | |
|-------------------------|-------------------|------------------|------------------------|------------------------|
| 1. Air Control | 4. VersaSage® Jet | 7. Light | 10. Pillow | 13. Temperature Sensor |
| 2. Euro Directional Jet | 5. Diverter Valve | 8. Ozone Jet | 11. Filter Compartment | 14. SPA FROG® Housing |
| 3. Euro-Pulse® Jet | 6. Drain | 9. Control Panel | 12. Assist Bar | |

ELECTRICAL INSTALLATION

ELECTRICAL REQUIREMENTS AND PRECAUTIONS

Your Caldera® Spa has been carefully designed to give you maximum safety against electrical shock. Connecting the spa to an improperly wired circuit will negate many of the spa's safety features. Improper wiring may also cause electrocution, risk of fire, and other risks of injuries. Please read and follow the electrical installation requirements and instructions for your spa completely!

230 VOLT PERMANENTLY CONNECTED

CALDERA SPAS MUST BE WIRED IN ACCORDANCE WITH ALL APPLICABLE LOCAL ELECTRICAL CODES. ALL ELECTRICAL WORK SHOULD BE DONE BY AN EXPERIENCED LICENSED ELECTRICIAN. WE RECOMMEND THE USE OF APPROPRIATE ELECTRICAL CONDUIT, FITTINGS, AND WIRE FOR ALL CIRCUITS.

An electrical subpanel containing two GFCI breakers is included with each spa. We recommend that this subpanel be used to supply power and protect the spa.

This subpanel requires a 50 amp, single phase, 230 volt, four wire service (two line, one neutral, one ground). The ground wire must never be less than #10 AWG. Use NEC 250-122 (table) and local codes for more information. A minimum #10 AWG solid copper bond wire is also required.

Mount the subpanel in the vicinity of the spa, but not within five feet, in accordance with local codes.

INSTALLATION INSTRUCTIONS

To connect the electrical service, first remove the screws from the equipment compartment door, lower the door one inch and remove the door.

1. Locate the spa control box. Remove the screws on the front of the control box and remove the control box cover.

2. Route the electrical service from the subpanel into the spa equipment compartment.

NOTE: The subpanel must be placed in sight of the spa, no closer than five feet.

3. Connect wire to bottom of control box using a minimum of 1/2" liquid-tight, flex conduit fitting.

WIRING CONNECTIONS

1. Identify the TB-1 terminal block, located inside the control box at the lower left-hand corner.

2. Connect the #12 AWG, BLUE wire, from the subpanel 20 amp breaker, terminal L1 to TB-1, terminal 1

3. Connect the #12 AWG, RED wire, from the subpanel 20 amp breaker, terminal L2 to TB-1, terminal 3

NOTE: The WHITE neutral wire must be attached to the LOAD neutral on the 230 volt, 30 amp breaker (not to the neutral bus bar in the subpanel). The WHITE neutral wire coming from the breaker itself is already connected to the neutral bus bar.

4. Connect the #10 AWG, BLUE wire, from the subpanel 30 amp breaker, terminal L1 to TB-1, terminal 2

5. Connect the #10 AWG, RED wire, from the subpanel 30 amp breaker, terminal L2 to TB-1, terminal 4

6. Connect the #10 AWG, WHITE wire, from the subpanel 30 amp breaker, terminal N (load neutral) to TB-1, terminal 5

7. Connect the #10 AWG, GREEN wire, from the subpanel GROUND bar to TB-1, system ground terminal.

8. Using the pressure wire connector provided on the outside of the control box, bond the spa to all exposed metal equipment or fixtures, handrails, and the concrete pad (if applicable) per N.E.C. and local codes.

9. Replace the control box cover and securely tighten the fastening screws. Close and secure the equipment compartment door as follows:

- Place top of door or panel directly below bartop against the frame of the spa.
- Push bottom of door or panel against the spa frame.
- Slide door or panel upward (pushing in on center of door) until screw holes line up.
- Slightly pull on door or panel, if door remains against the spa then replace the screws.
- If the door does not lock into position, repeat the previous steps.

⚠ WARNING: FILL THE SPA WITH WATER BEFORE TURNING ON THE POWER! (See STARTUP AND REFILL PROCEDURES.)

Once your spa has been filled with water, turn it on and test all of the circuit breakers.

NOTE: If both breakers immediately trip, verify that the #10 AWG WHITE neutral wire is connected from TB-1 terminal 5 to the N (load neutral) terminal of the 30 amp subpanel breaker. Each breaker should be tested prior to each use. Here's how:

1. Push the "TEST" button on each GFCI breaker, and observe it click OFF.

2. Wait 30 seconds, then push the breaker switch to the OFF (down) position (to ensure that it has completely disengaged), then push the breaker switch to the ON (up) position. If you don't wait 30 seconds, the spa's control panel may flash four lines on and off – try again.

If any of the GFCI breakers fails to operate in this manner, your spa may have an electrical malfunction, and you may be at risk of electrical shock. Turn off all circuits and do not use the spa until the problem has been corrected by an authorized service agent.

SERVICE NOTE: All Caldera spas have diagnostic functions that are displayed on the control panel. The control panel will display four flashing lines if the heater high limit thermostat has tripped. If the four flashing lines are visible, follow the instructions in the troubleshooting section to identify and correct the cause. The four flashing lines will stop flashing once the problem has been corrected.

⚠ WARNING: Removing or bypassing any GFCI breaker will result in an unsafe spa and will void the spa's warranty.

IMPORTANT: If you ever need to move or relocate your Caldera spa, it is essential that you understand and apply these installation requirements. Your Caldera spa has been carefully engineered to provide maximum safety against electric shock. Remember, connecting the spa to an improperly wired circuit will negate many of its safety features.

NOTE: Long wiring runs may require larger-gauge wire than stated.

ELECTRICAL INSTALLATION

PARADISE SERIES WIRING DIAGRAM

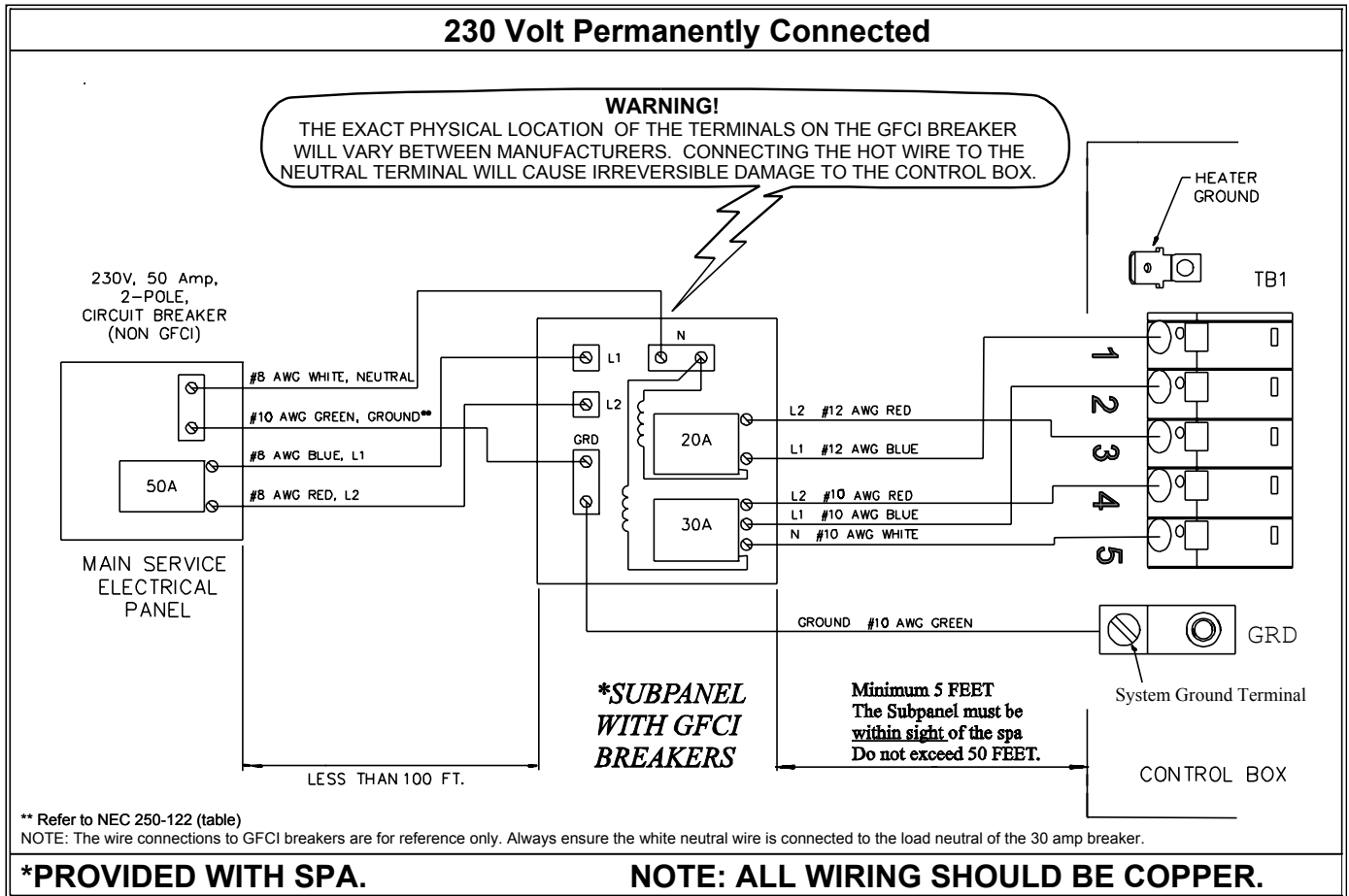

POWER CONNECTION ACCESS

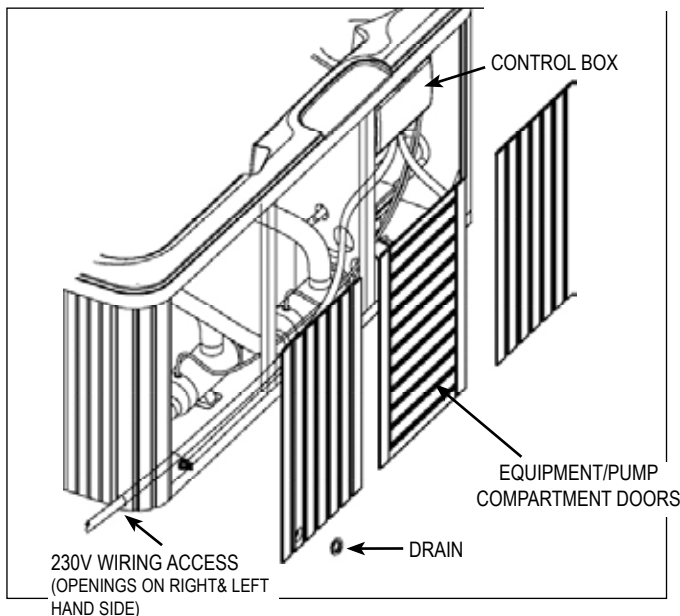

MOOREA AND HAWAIIAN MODELS

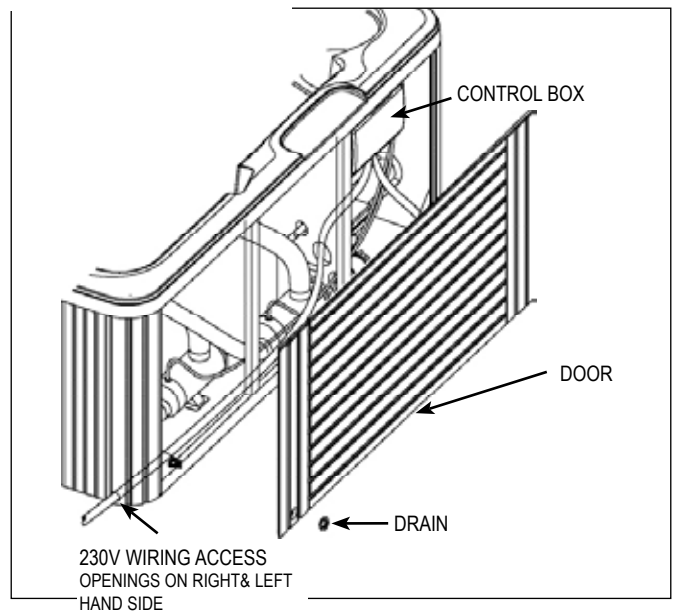

KAUAI AND MARTINIQUE MODELS

START-UP AND REFILL PROCEDURES

Your Caldera® spa has been thoroughly tested during the manufacturing process to ensure reliability and long-term customer satisfaction. A small amount of water may have remained in the plumbing after testing and, as a result, may have spotted the spa shell or the spa siding prior to delivery. Before filling the spa, clear all debris from the spa and wipe the spa shell clean with a soft rag.

THE FOLLOWING INSTRUCTIONS MUST BE READ AND FOLLOWED EXACTLY TO ENSURE A SUCCESSFUL START-UP OR REFILL.

CAUTIONS

- **Do not fill the spa with hot water, as tripping of the high-limit thermostat may result.**
 - **DO NOT CONNECT POWER TO AN EMPTY SPA. Power to the spa automatically activates critical components within the spa, such as controls, heater, circulation pump and other systems. If power is supplied to these components prior to the spa being filled, the components will be damaged, and this may result in a non-warranty component failure.**
 - **Do not use your spa after filling until all of the steps listed below are completed.**
 - **Do not add chlorine if treating your spa with polyhexamethylene biguanide (Biguanide, PHMB, eg. BaquaSpa® or Soft Soak®) sanitizer.**
 - **Before filling your spa for the first time, remove the equipment compartment doors and check to ensure that the unions on either side of the pump are hand-tight.**
1. Close external drain valve and remove the skimmer basket, weir and filter. Then insert the end of a garden hose into the filter hole and begin filling the spa. The water level of your Caldera spa should be maintained at a level one inch above the highest jet in the spa. Reinstall the skimmer basket, weir and filter once the spa is filled.
IMPORTANT: Watkins Manufacturing Corporation does not recommend that the spa be filled with “softened” water, as this may damage the spa’s equipment.
 2. Install SPA FROG® bromine and mineral cartridges.
 - a. Turn off power to the spa.
 - b. Unscrew SPA FROG cap on top edge of spa.
 - c. Turn handle counter-clockwise.
 - d. Lift cartridge holder up and out of spa.
 - e. Turn top cap of mineral cartridge to setting #6. (The mineral cartridge should last 4 months.) Turn top cap of bromine cartridge to setting #6.
NOTE: Adjust bromine cartridge setting down by one setting each day until a residual of 1.0 - 2.0 ppm level of bromine is established. (The bromine cartridge should last 2 - 4 weeks.)
 - f. Snap bromine cartridge in at bottom of holder and mineral cartridge on top.
NOTE: It is important that the bromine cartridge is on bottom; otherwise, the bromine cartridge could be dispensed prematurely.
 - g. Reinstall cartridge holder into spa, push down, and twist clockwise.
 - h. Replace the SPA FROG cap, and reconnect power to the spa.**WARNING:** High sanitizer levels can cause discomfort to the user’s eyes, lungs and skin. Always allow the sanitizer level to fall to the recommended range before using the spa.
 3. **AFTER** the spa has been filled with water and the equipment compartment door is secured, power must be applied to the spa.
 - Activate power to the subpanel from the main house panel first.
 - Open the door of the electrical subpanel and reset the GFCI breakers.
 - Close and secure the subpanel door.
 4. The jet pump(s), heating system and all internal plumbing will achieve a partial prime as the spa is filled. To activate the spa, press the AIR button (except for Martinique® and Kauai®), followed by JETS 2 (except for Kauai), followed by JETS 1. Once the jet system is fully operational (as indicated by strong, non-surfing jets), priming of the spa is complete. Turn off spa. If you do not feel a steady stream of water from your jets, refer to the instructions for priming the pump in the SPA TROUBLESHOOTING section in the back of this manual.
IMPORTANT: Be sure that the air control valves are open by turning each one counterclockwise and checking to see that all the diverters are in position 1 or position 2 (see illustration on diverter valves).
 5. Adjust Total Alkalinity (TA) to 80 - 180 ppm, Calcium Hardness (CH) to 150 - 400 ppm, then spa water pH to between 7.2 and 7.8. These procedures are listed in the “Water Quality and Maintenance” section.
OPERATION NOTE: Adjust the Total Alkalinity first, as out-of balance TA will affect your ability to adjust the pH correctly and will prevent the sanitizer from operating effectively.
IMPORTANT: Add spa water chemicals directly over the filter compartment (remove filter lid) with the jet pump on for at least ten minutes (press “CLEAN” button on the control panel). Make sure all the diverter valves are set to the middle position.
 6. Set the temperature control to the desired temperature between 100°F (38°C) and 104°F (40°C), then place the vinyl cover on the spa and allow the water temperature to stabilize (approximately 24 hours). Make sure you secure the cover in place using the cover locks. Periodically check the spa water temperature. When the water temperature climbs above 90°F (32°C), proceed to the next step.
 7. Press “CLEAN” button on the control panel, this will run the Jet Pump 1 (Jets 1) for a total of ten minutes to circulate the spa water. Make sure all the diverter valves are set to the middle position. Once the jets shut off, test the spa water for bromine residual. If the residual is between 1 and 2 ppm, go on to the next step. If the residual is less than 1 ppm, repeat previous step until a bromine residual of 1-2 ppm is established.
 8. Recheck the Total Alkalinity (TA) at 80-180 ppm, Calcium Hardness (CH) at 150-400 ppm, then spa water pH at between 7.2 and 7.8.
OPERATION NOTE: Make sure you adjust your Total Alkalinity first, as an out-of-balance condition will affect your ability to adjust the pH correctly, and will prevent the sanitizer from operating effectively. **The spa is ready for use when the spa water has circulated and the bromine level remains between 1 ppm and 2-ppm.**

START-UP AND REFILL PROCEDURES

9. The spa temperature is pre-programmed to reach 102°F (39°C), and will normally do so within 18 to 24 hours. You may raise the water temperature by pressing the **TEMP (▲)** button on the control panel once to display the temperature, then pressing it again within five seconds to raise the temperature, or lower it by pressing **TEMP (▼)** button once to display the temperature, then pressing it again within five seconds to lower the temperature. After a few hours, the water temperature will remain within 1-1/2 degrees of your selected temperature.

OPERATION NOTE: For proper water circulation during the ten-minute clean cycle the following steps should be performed.

- Place the diverters valves in the middle (split flow) position.
- Place air control levers in OFF position by rotating clockwise.

CUSTOMIZING YOUR MASSAGE

Your Caldera® spa offers numerous ways for you to customize your massage experience. Experimentation is the best way to find what feels best to you. Try sitting in different seats, adjusting the diverter valves, air controls, and jet nozzles and turning each pump on or off.

DIVERTER VALVES

The diverter valves on your spa allow you to direct the flow of water from the pumps to various combinations of jets. The functions of these diverter valves can best be learned by experimentation as follows:

1. Set all air controls to the "ON" position by rotating counterclockwise.
2. Turn on both pumps.
3. Turn the handle on each diverter valve and see which groups of jets are affected.
(Note: You can adjust the diverter valves to any position between the two possible extremes to achieve the jet pressure that feels best to you.)

IMPORTANT: Your spa is not designed to provide full power to all jets when the diverter valves are in the "mid" position. However, with the diverter valve in this position, you may increase the power to selected jets by rotating the face of the VersaSsage®, AdaptaSsage™ and AdaptaFlo™ jets to close the ones that are not in use.

TIP: Turn both pumps on and place the diverter valves to the "Mid-Position", then experiment with each of the air controls to see their effect.

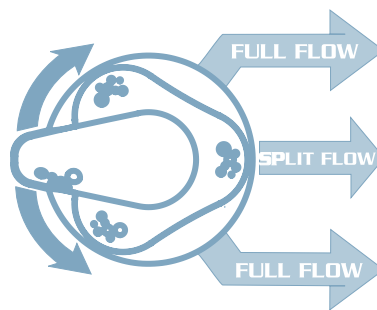

Position 1 - The full flow is directed to one series of jets.

Mid-Position - Positioning the diverter at any point between position one and two divides the flow between the jet systems.

Position 2 - The full flow is directed to a second series of jets.

WATERFALL VALVE

The Moorea®, Hawaiian, and Martinique® spas are equipped with a cascading waterfall feature. It is activated by pressing JETS2 and turning the the valve located on the front interior wall counterclockwise. The flow is regulated by turning the waterfall valve to the desired position.



AIR CONTROLS

Each jet system has its own air control. These allow you to change the power of the jets by regulating the amount of air that is mixed with the water coming out of the jets.

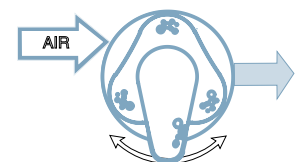

HYDRO JETS

AdaptaFlo Jets - These jets allow you to redirect the jet stream by changing the position of the nozzle.

AdaptaSsage Jets - These jets provide a rotating massage pattern.

The face plates in the AdaptaFlo jets and the AdaptaSsage jets are interchangeable. To remove a AdaptaSsage face plate, turn it counter-clockwise until it stops turning. Turn the face once more until you hear a clicking noise, push it in, and then pull it straight off. Install the face plate by snapping it into place. Additional AdaptaSsage dual-port nozzles are available from your Caldera dealer.

Both the AdaptaFlo and AdaptaSsage jets allow you to regulate the force of the massage. Rotate the fascia ring counter-clockwise to reduce the force, or clockwise to increase the force. Notice that turning off the flow to some jets increases the flow to the other jets. To avoid damage to your spa's plumbing and components, do not turn off more than half of these jets at the same time.

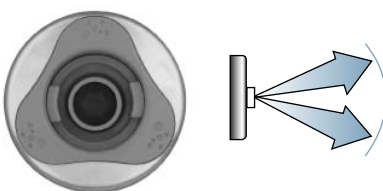
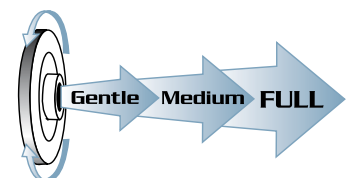

Adaptaflo Jet

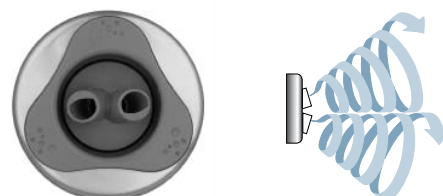

AdaptaSsage Jet

CUSTOMIZING YOUR MASSAGE

Euro Directional and Euro-Pulse® Jets - The Euro Directional jets, with eyeball nozzles, deliver a direct, more focused massage. The Euro-Pulse jets feature a special insert that creates a soft, pulsating, rotary massage. The Euro-Pulse jet cap assemblies may be removed if you want a more powerful, direct massage in the wrist locations. To do this, rotate the jet face counter clockwise and pull off. Then simply press and twist Euro Directional Jet into place. If you desire, you may install a Euro-Pulse jet in place of any of the Euro Directional jet by simply following the same procedure as mentioned. You may purchase additional rotary jet assemblies from your Caldera® dealer.

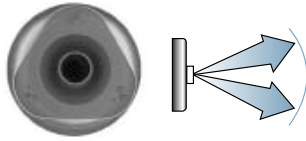

Euro Directional Jet

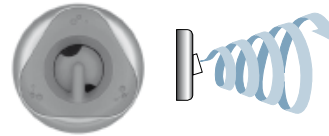

Euro-Pulse Jet

VersaSsage Jets - These jets may be adjusted to provide either a stationary, direct stream or, by positioning the nozzle to one side or the other, a rotating jet stream. The VersaSsage jets allow you to regulate the force of the massage. Rotate the fascia ring counter-clockwise to reduce the force, or clockwise to increase the force. Notice that turning off the flow to some jets increases the flow to the other jets. To avoid damage to your spa's plumbing and components, do not turn off more than half of these jets at the same time. For cleaning instructions, see the VersaSsage Jets Maintenance section.

OrbiSsage® Jet (Optional) - The OrbiSsage Jet can replace the VersaSsage Jet to provide a unique, soothing massage.

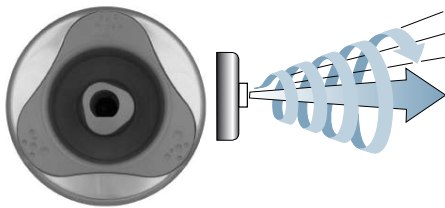

VersaSsage Jet

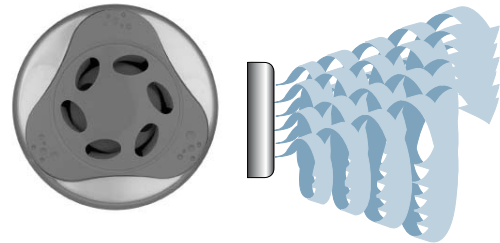

OrbiSsage Jet

Euphoria® Jet - The Euphoria jet provides a deep powerful, penetrating massage to your tired feet, calves, knees and thighs.

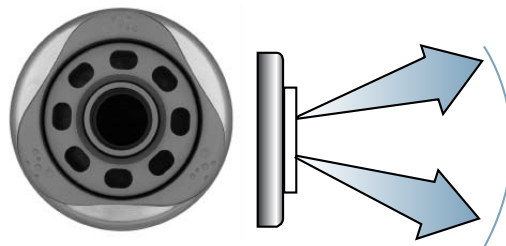

Euphoria Jet

AIR JETS

The air jet system consists of a 1 HP air pump and 10 air jet found on the Moorea™ and Hawaiian spas. The air jets deliver air bubbles to provide a subtle pulsation for gentle, soft-tissue massage. At the beginning of the automatic operation cycle, the air jets will operate for one minute to clean out the air channel.

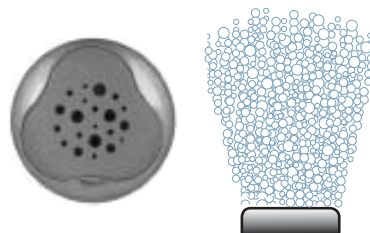

Air Jet

JET MENU

MOOREA®

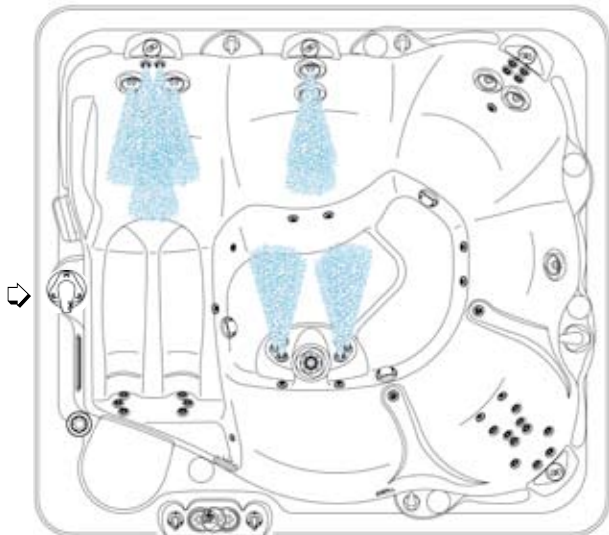

JET PUMP 1–JET SYSTEM 1

Located in UltraMassage™ lounge – left

- 3 VersaSsage® jets
- 2 Euro Directional jets

Located in Reclining Seat

- 2 VersaSsage® jets – on back wall
- 6 Sole Soothers®

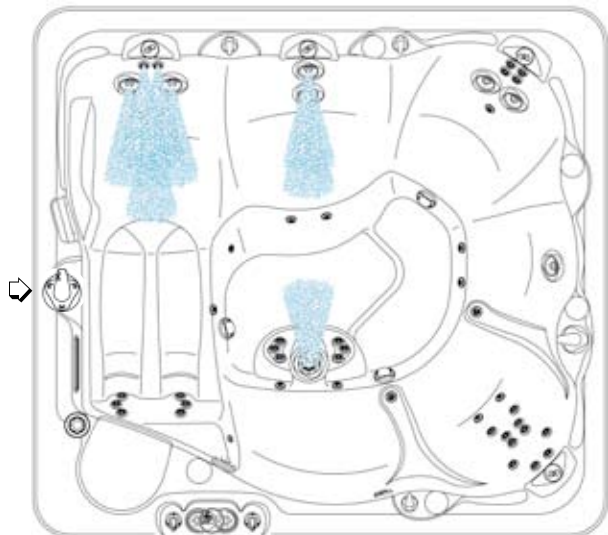

JET PUMP 1–JET SYSTEM 2

Located in UltraMassage lounge – left

- 3 VersaSsage jets
- 2 Euro Directional jets

Located in Reclining Seat

- 2 VersaSsage jets – on back wall
- 1 Euphoria® jet in footwell

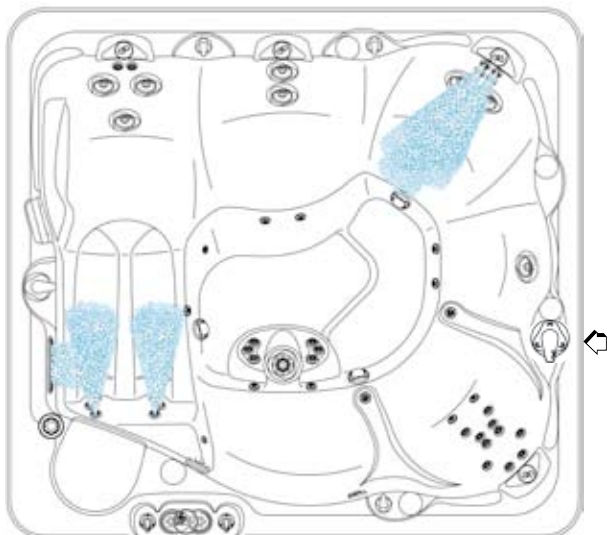

JET PUMP 2–JET SYSTEM 1

- Waterfall

Located in UltraMassage lounge – left

- 6 Sole Soothers jets

Located in LumbarSsage® seat – back right

- 4 Euro Directional jets
- 2 VersaSsage jets

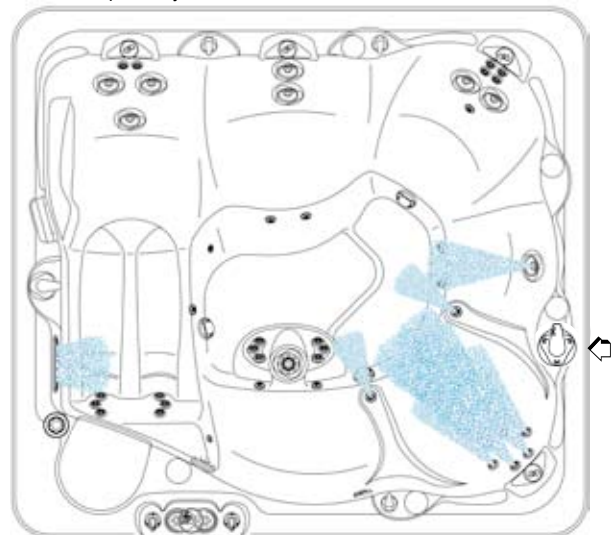

JET PUMP 2–JET SYSTEM 2

- Waterfall

Located in Single Jet Seat

- 1 AdaptaFlo™ jet

Located in Ecsta Seat® – front right

- 10 Euro Directional jets
- 2 Euro-Pulse® jets

COMBINATION JET SYSTEM

Jet Pump 1 diverter in mid position activates both Jet Pump 1 Systems 1 and 2.
Jet Pump 2 diverter in mid position activates both Jet Pump 2 Systems 1 and 2

JET MENU

HAWAIIAN

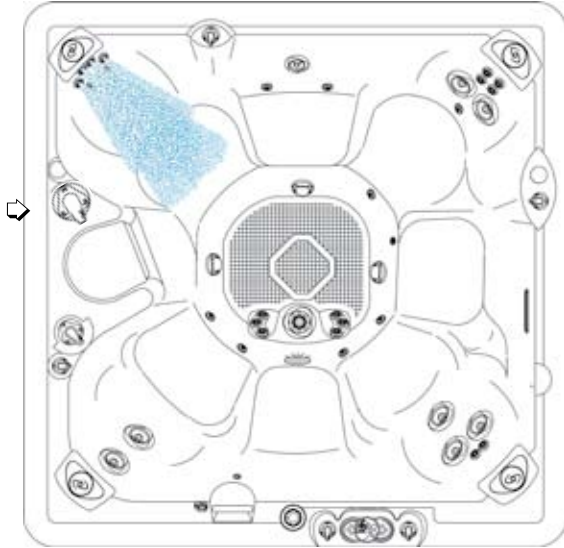

JET PUMP 1-JET SYSTEM 1

- Located in Ecsta Seat® – back left
- 10 Euro Directional jets

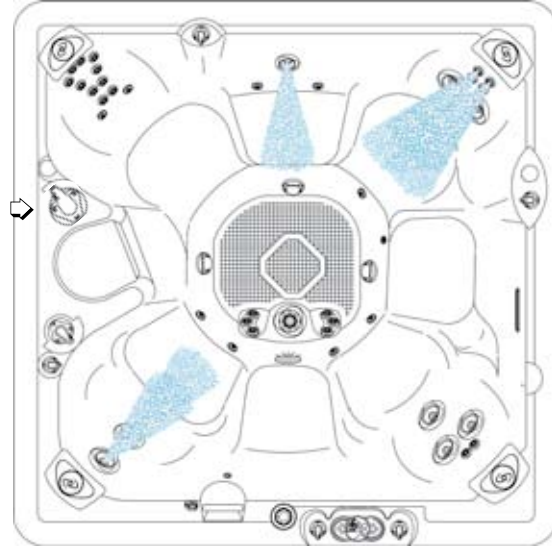

JET PUMP 1-JET SYSTEM 2

- 2 VersaSage® jets in front left corner
 - 1 AdaptaFlo™ jet on back center wall
- Located in LumbarSage® seat – back right
- 4 Euro Directional jets
 - 2 VersaSage® jets

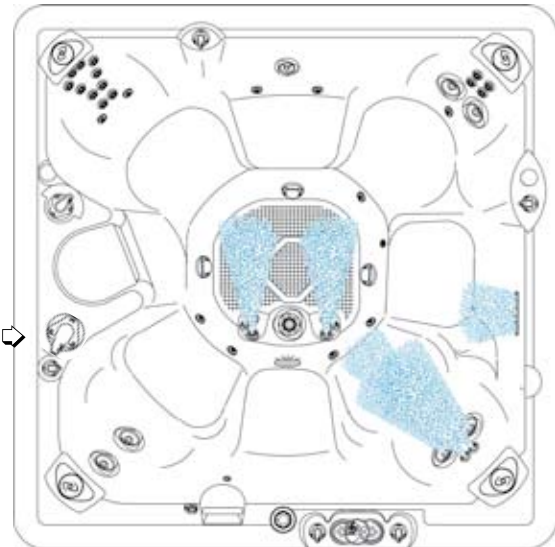

JET PUMP 2-JET SYSTEM 1

- Waterfall
 - 6 Sole Soothers® in footwell
- Located in UltraMassage seat – front right
- 3 VersaSage jets
 - 2 Euro Directional jets

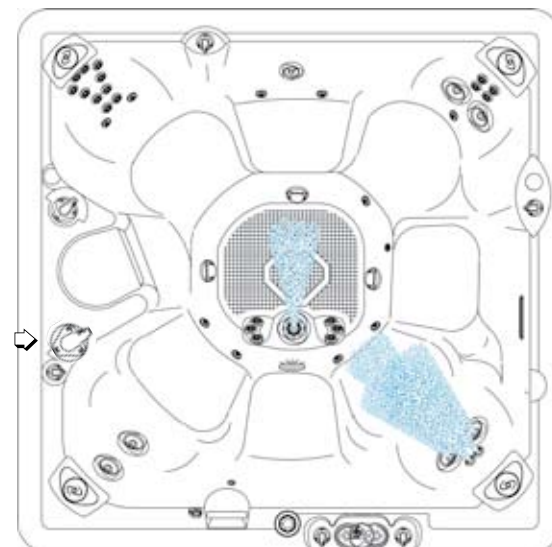

JET PUMP 2-JET SYSTEM 2

- 1 Euphoria® jet in footwell
- Located in UltraMassage seat – front right
- 3 VersaSage jets
 - 2 Euro Directional jets

JET MENU

MARTINIQUE®

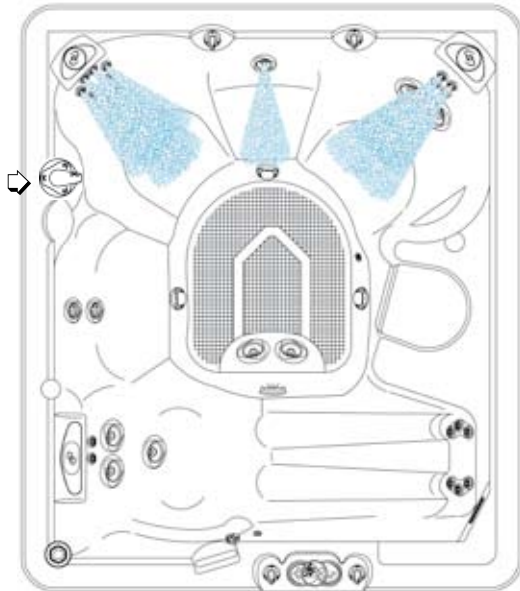

JET PUMP 1-JET SYSTEM 1

Located in Ecsta Seat® – back left :

- 8 Euro Directional jets

Located in LumbarSage® Seat – back right

- 4 Euro Directional jets
- 2 VersaSage® jets

Located in Center seat

- 1 AdaptaFlo™ jet

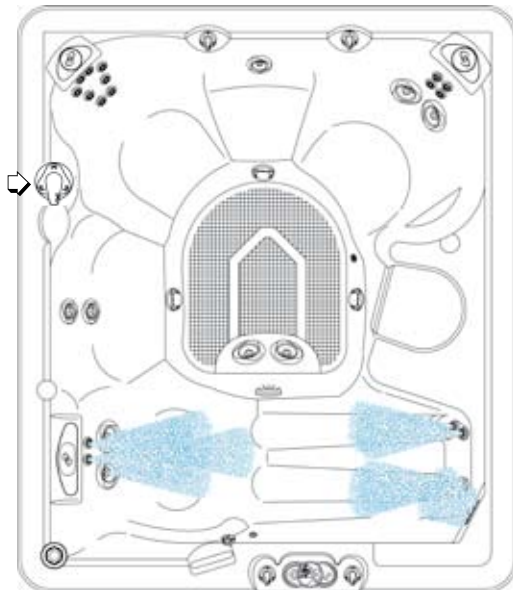

JET PUMP 2-JET SYSTEM 1

Located in UltraMassage lounge – front

- 6 Sole Soothers®
- 3 VersaSage jets
- 2 Euro Directional jets
- Waterfall

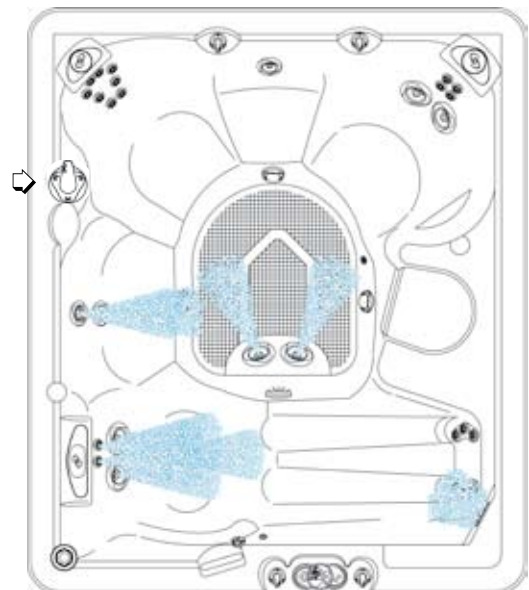

JET PUMP 2-JET SYSTEM 2

- 2 AdaptaSage™ jets on left wall
- 2 VersaSage jets in foot well

Located in UltraMassage lounge – front:

- 2 Euro Directional jets
- 3 VersaSage jets
- Waterfall

COMBINATION JET SYSTEM

Jet Pump 2 diverter in mid position activates both Jet Pump 2 Systems 1 and 2.

JET MENU

KAUAI®

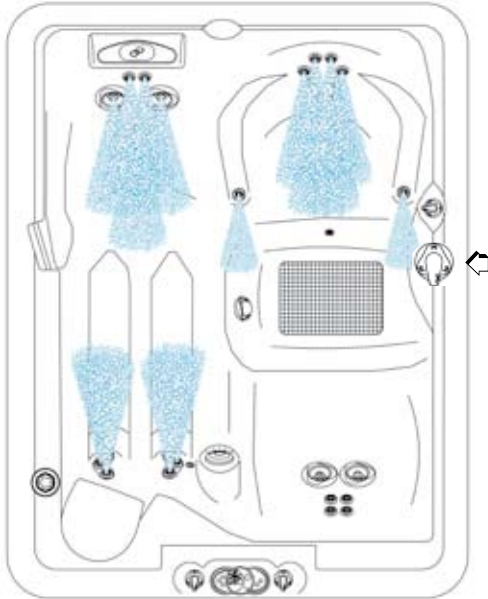

JET PUMP – JET SYSTEM 1

Located in UltraMassage lounge

- 6 Sole Soothers®
- 3 VersaSsage® jet
- 2 Euro Directional jets

Located in Ecsta Seat®

- 8 Euro Directional jets
- 2 Euro-Pulse® jets

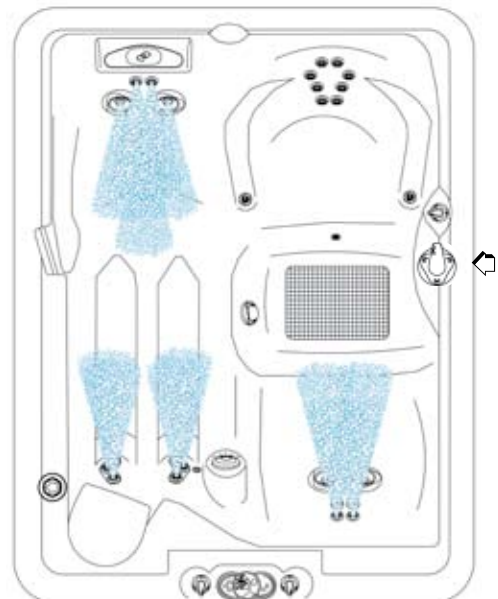

JET PUMP – JET SYSTEM 2

Located in UltraMassage lounge

- 6 Sole Soothers
- 3 VersaSsage jets
- 2 Euro Directional jets

Located in LumbarSsage® seat

- 4 Euro Directional jets
- 2 VersaSsage jets

COMBINATION JET SYSTEM

Jet Pump diverter in mid position activates both Jet Pump Systems 1 and 2.

OPERATING INSTRUCTIONS

CONTROL PANELS

Moorea® • Hawaiian

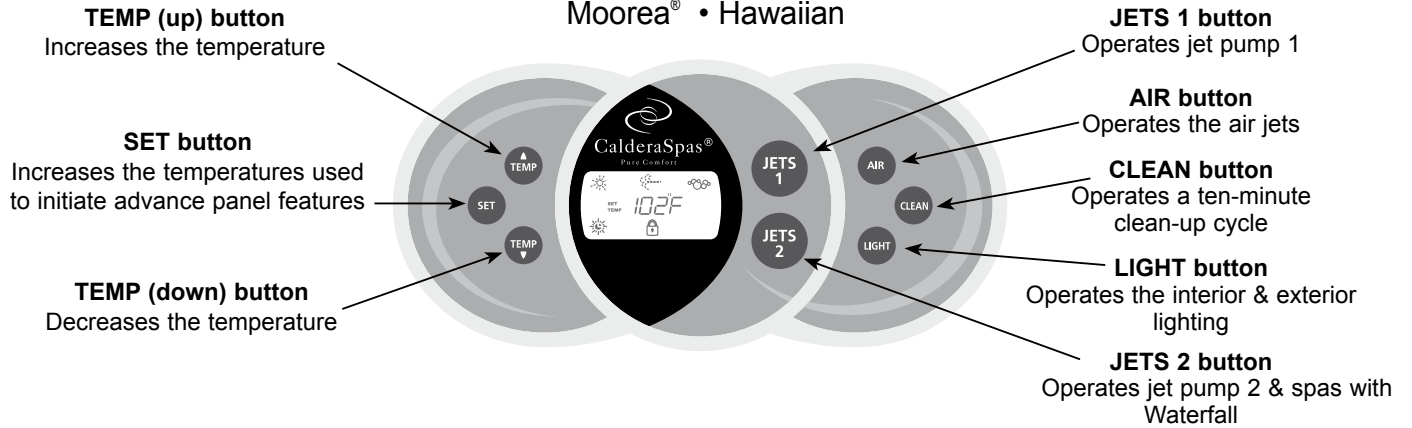

Martinique®

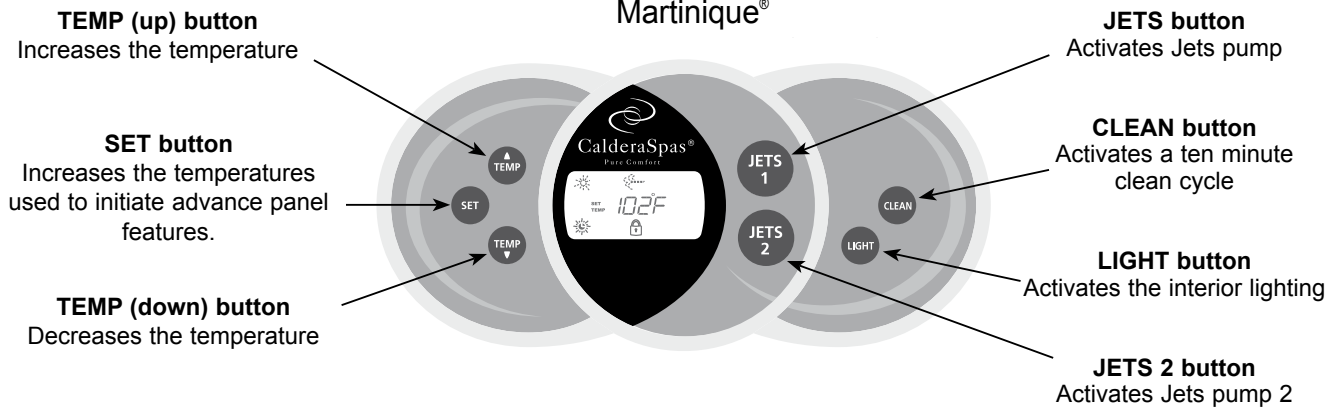

Kauai®

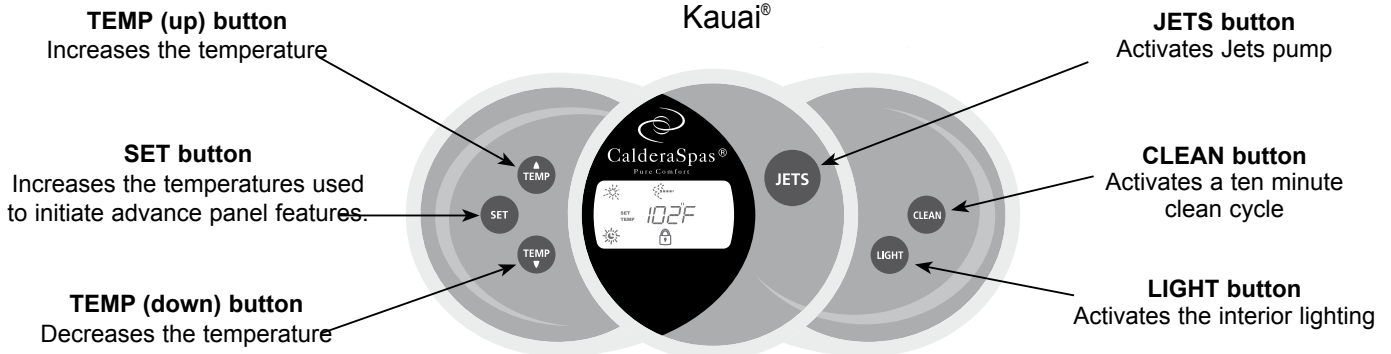

OPERATING INSTRUCTIONS

LOCKING FEATURES

The locking features, TEMPERATURE LOCK and SPA LOCK, are enabled from the control panel by a specific combination of buttons. Once enabled, a lock will remain active until the specific button combination is applied to disable the lock. Even if power is disconnected from the spa and soon thereafter reapplied (such as a power outage), the lock will remain in place.

The "SET" button is used to initiate advance panel features such as the spa panel lock, temperature lock, and optional color wheel mode.

SPA LOCK



The Spa Lock feature deactivates all of the functions of the control panel. It is generally used to prevent unwanted use of the spa.

To activate the Spa Lock, press "SET" button + "TEMP ▼" button and hold for three seconds until the SPA and lock symbol are illuminated.

To deactivate the Spa Lock, press "SET" button + "TEMP ▼" button and hold for three seconds until the SPA and lock symbol are no longer illuminated.

TEMPERATURE LOCK



The Temperature Lock feature deactivates the temperature control function from the control panel. All other functions on the control panel will operate normally. Temperature Lock is most often used by those who do not want others to change the set temperature of the spa water.

To activate the Temperature Lock, press "SET" button + "TEMP ▲" button and hold for three seconds until lock symbol is illuminated.

To deactivate the Temperature Lock, press "SET" button + "TEMP ▲" button and hold for three seconds until the lock symbol is no longer illuminated.

MAIN CONTROL PANEL BUTTONS AND DISPLAY

Your spa control panel is illuminated with a Light Emitting Diode (LED) and uses convenient push buttons that allow you to set the water temperature as well as the hydrotherapy jets and mood lighting.

DISPLAY INVERSION

You may invert the main, four-digit display for easier viewing from inside the spa. Press and hold the "SET" button for three seconds until the display is inverted. Press and hold the "SET" button for three seconds a second time to invert the four-digit display back to its original position.

TEMPERATURE CONTROL



The set temperature range is from 80°F (27°C) to 104°F (40°C). The set temperature of the spa water will automatically be 102°F (39°C) the first time power is applied. This is the setting programmed at the factory. After the spa has been set up and used, the last temperature value set by the user will be stored in memory. If power is disconnected from the spa, it will automatically revert to the last set temperature when power is reapplied. (Temperatures of any setting may rise slightly depending on the current use and condition of your spa, and on outside temperature.)

To display the set temperature of the spa, press the "TEMP ▲" or "TEMP ▼" button. The set temperature will be displayed, unless the spa is locked (in which case the word SPA is displayed with the lock symbol). The set temperature display will automatically return to actual temperature after five seconds. To increase the set temperature of the spa water, press the "TEMP ▲" button. Each time the button is pressed, the set temperature display will increase by one degree. If the button is held down, the set temperature display will increase by one degree every half-second.

To decrease the set temperature of the spa water, press the "TEMP ▼" button. Each time the button is pressed, the set temperature display will decrease by one degree. If the button is held down, the set temperature display will decrease by one degree every half-second.

If the set temperature value will not change, check the TEMP LOCK and SPA LOCK features. When either of these features are applied, the temperature control is disabled.

JETS BUTTON



Your spa model uses one, or two buttons which affect the jet pump(s):

The "JETS 1" ("JETS" for Kauai®) button activates jet pump 1. When the "JETS 1" button is pressed, the jets symbol will illuminate on the control panel display. The symbol will remain lit until the button is pressed to turn off jet pump 1, or after one hour of continuous operation when the pump automatically shuts off.

The "JETS 2" button (used on Moorea™, Hawaiian and Martinique®) activates jet pump 2. On the Moorea, "JETS 2" also activates the cascading waterfall feature. When the "JETS 2" button is pressed, the jets symbol will illuminate on the control panel display. The symbol will remain lit until the button is pressed to turn off jet pump 2, or after one hour of continuous operation when the pump automatically shuts off.

MANUAL CLEAN CYCLE

The "CLEAN" button has been provided as a convenient timer for water maintenance. When the "CLEAN" button is pressed, jet pump 1 will activate. The jet pump symbol will flash on and off until the cleaning cycle is complete. The total cleaning cycle time is ten minutes. If the clean cycle does not engage, make sure the SPA LOCK is deactivated. SPA LOCK disables the controls on the control panel.

AIR JETS BUTTON



The "AIR" button activates the air blower (not available on the Martinique and Kauai). When the "AIR" button is pressed, the air symbol will illuminate on the control panel display. The symbol will remain lit until the button is pressed to turn off the air blower, or after 15 minutes when the blower automatically shuts off. While the air blower is on, air only jets are operating throughout the spa. To stop the air blower when active, simply press the "AIR" button.

OPERATING INSTRUCTIONS

LIGHT CONTROL

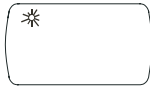

The "LIGHT" button activates the light and controls the intensity. Pressing the "LIGHT" button operates the light as follows:

- 1st press of the "LIGHT" button – light will turn on to the maximum intensity.
- 2nd press of the "LIGHT" button – light will turn to medium intensity.
- 3rd press of the "LIGHT" button – light will turn to low intensity.
- 4th press of the "LIGHT" button – light will turn off.

If the light is left on, it will automatically turn off after 6 hours of continuous operation. The light symbol on the control panel will also turn off when the light is deactivated. If the light will not turn on, make sure SPA LOCK is deactivated. SPA LOCK disables the functions on the control panel.

LIGHT CONTROL (SPAGLO® LIGHTING SYSTEM - OPTIONAL)

If your spa is equipped with the optional SpaGlo lighting system, the spa and grab bar will change colors via a color wheel. The color wheel may be stopped on any color. The following buttons must be pressed to start and stop the wheel:

Press the "SET" + "LIGHT" button simultaneously while the light is on to start or stop the color wheel. The light symbol will flash on and off when the color wheel is on, and the light symbol will display continuously when the wheel is stopped.

SUMMER MODE



Your Caldera® spa is equipped with a Summer Mode timer. The Summer Mode timer can be activated during extremely hot summer months if it becomes difficult to maintain water temperatures low enough for comfort. Upon switching to the ON mode, the heater will immediately shut down while the circulation pump (which can add heat to the water through normal operation) will remain on for approximately 5 minutes for heater cool-down. Both heater and circulation pump will remain off for the next eight hours. Additionally, the summer mode display on the main control panel

will activate and remain active for as long as the summer mode is on. Following this eight hour period, the circulation pump, and heater will continue to turn off for an eight hour period every day that the switch remains in the ON position. In this way, the amount of heat transferred to the spa water will be minimized. When the outside temperatures begin to cool, the Summer Mode timer should be turned to the OFF position (the summer mode display on the main control panel shut off). This is the efficient 24 hour circulation mode that keeps the heater operation and operating costs to a minimum during colder/heavier usage months.

NOTE: Whenever power is disconnected and then reconnected to the spa, the Summer Mode timer will reset starting with the 8-hour shutdown mode. If a different 8-hour shut down time is desired, deactivate the Summer Mode, then reactivate at the beginning of the desired 8-hour shut down time.

IMPORTANT: The Summer Mode will not lower the spa's waters temperature below the ambient air temperature.

To activate the Summer Mode, simply follow these steps:

1. Set the temperature control to 80°F (27°C)
2. On the control panel, simultaneously press and hold for 3 seconds "TEMP ▲" and "TEMP ▼" to activate the Summer Timer.

The Summer Mode must be deactivated when cooler temperatures return. To do this, simply repeat step 2.

EQUIPMENT COMPARTMENT

JET PUMP SIDE

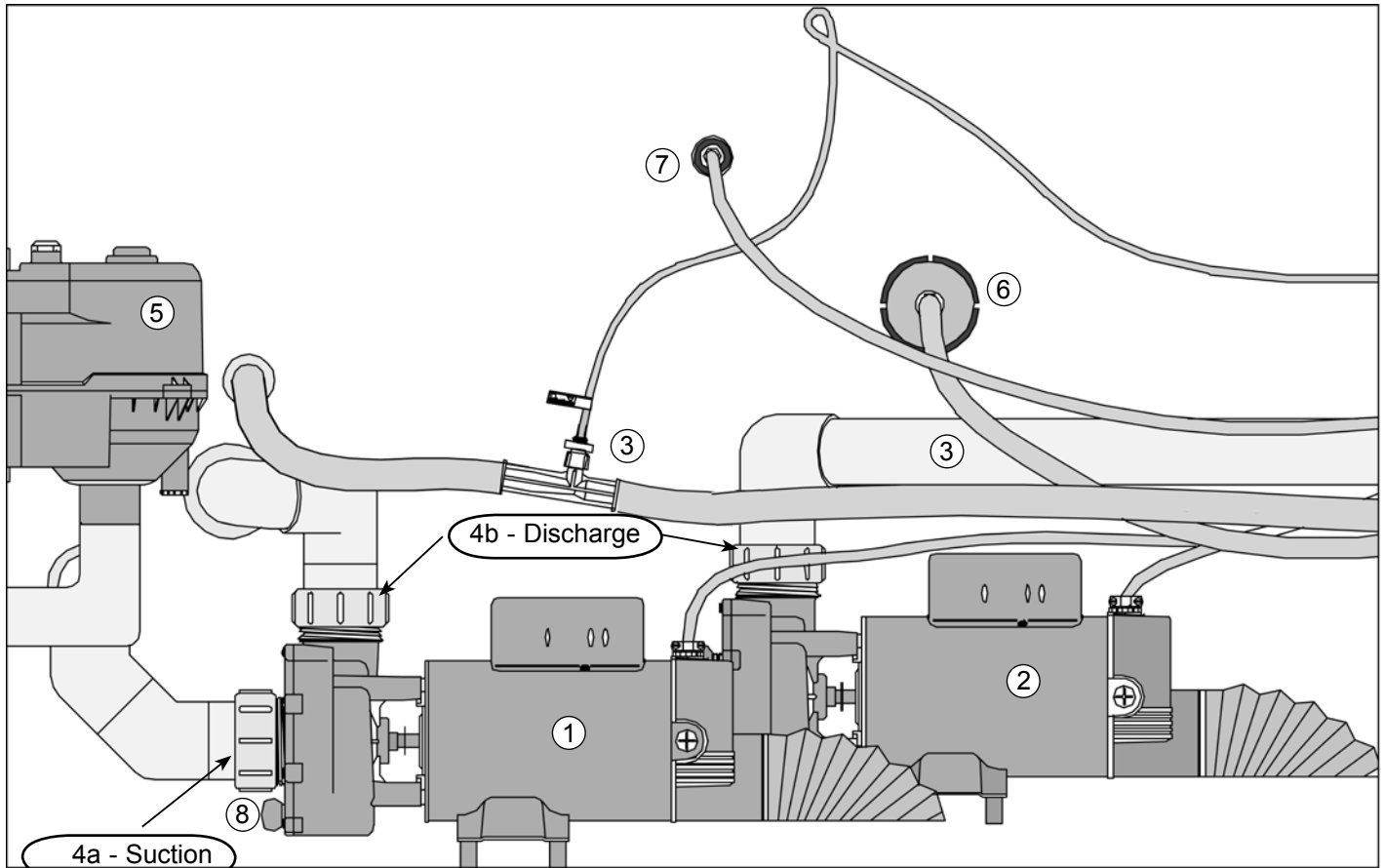

Hawaiian[®], Moorea[®], and Martinique[®]

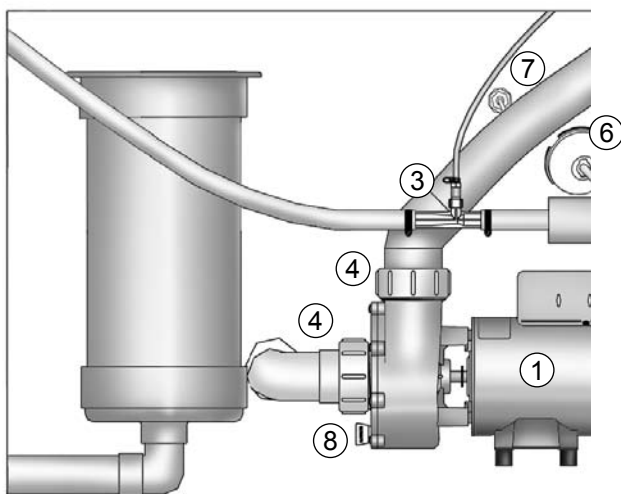

Kauai[®]

1. Jet Pump #1
2. Jet Pump #2
3. Ozone Injector (Included with the Optional Monarch[®] CD Ozone Generator kit)
4. Unions
5. Air Blower*
6. Light
7. Temperature Sensor
8. Pump Drain Plug

* Air Blower available on the Hawaiian and Moorea spas only

EQUIPMENT COMPARTMENT

CONTROLS SIDE

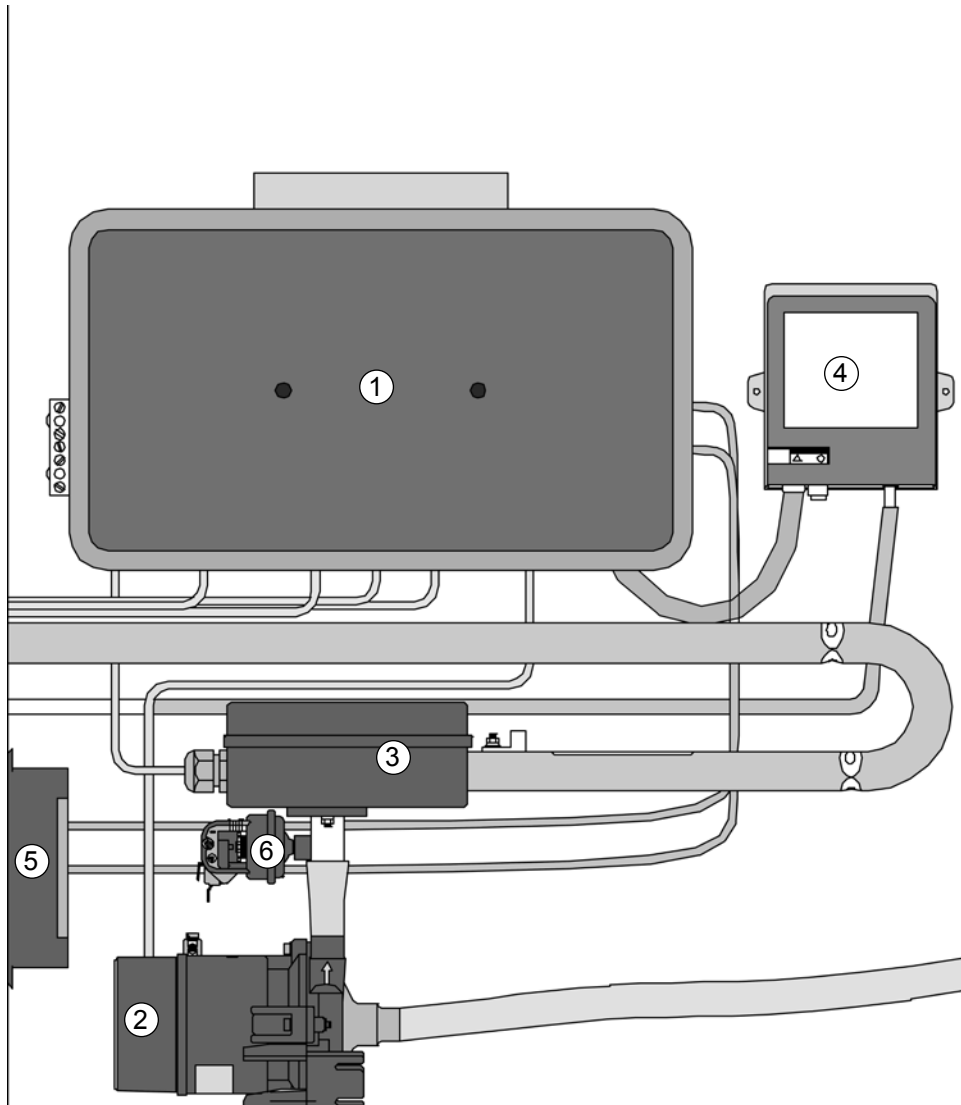

- Advent® Control Box System
- EnergyPro® Circulation Pump
- EnergyPro Flow-Through Heater
- Monarch® CD Ozone Generator (optional)
- SpaGlo® LED Light System (optional)
- Pressure Switch

MAINTENANCE

FILTER MAINTENANCE

At least once a week, check and clean the skimmer basket and weir to ensure proper filter flow. Remove leaves, foreign matter, and debris. It is very important to keep your spa filter cartridge clean and free of particles to ensure proper water flow. A clean filter permits the hydrotherapy system to function properly and also allows more efficient filter cycles. Depending on how frequently your spa is used, we recommend cleaning the spa filter cartridge every four weeks. If this is not done, the filter may clog and restrict water flow, which causes improper filtration and poor jet performance.

IMPORTANT: The frequency and duration of use, and the number of occupants all contribute to determining the appropriate time between filter cleanings. More use means that more frequent filter cleanings will be required.

FILTER CARTRIDGE REMOVAL AND CLEANING INSTRUCTIONS

1. Turn off power to the spa.
2. Push the filter basket down slightly and turn counter-clockwise to unlock. Then pull out the basket and weir.
3. Carefully pull up the filter cartridge and bring it out of the spa.
4. Always clean the filter using a filter degreaser to remove mineral and oil build-up. Soak the filter in the degreaser (according to the package directions). Then place the filter on a clean surface and, using a garden hose, spray until it is clean. It may be necessary to rotate the filter while spraying to remove any debris lodged between the filter pleats.
5. Replace the cartridge in the spa. To return the basket and weir, insert and rotate clockwise to lock into position.
6. Turn on power to the spa.

NOTE: Replacement filter cartridges are available from your Caldera® dealer. Refer to the back of this manual to determine the appropriate size for your spa.

DIVERTER VALVE MAINTENANCE

If your spa's diverter valves become difficult to turn, it is likely that sand or grit has become lodged inside the valve body. It is very important that this debris is removed as soon as possible to avoid damage to the valve. To clean the valves, follow these steps:

1. Turn off power to the spa.
2. Remove the diverter valve's handle by pulling upward while rocking it back and forth.
3. Unscrew the cap ring.
4. Remove the valve body by pulling it upward.
5. Wipe the valve body and the interior walls of the valve clean.
6. Lubricate the o-rings with a waterproof lubricant available from your Caldera dealer.
7. Reassemble the valve and turn on power to the spa.

VERSASSAGE® JETS MAINTENANCE

If the VersaSage jets spin slower than when the spa was new, or the jets are sticking, it may be due to a build-up of deposits inside the jet bearings. To remove the deposits, follow these instructions:

1. With the spa off, rotate the VersaSage jet face counter-clockwise until it stops.
2. Once the face stops rotating, use a little extra force to rotate the face counter-clockwise past the locking position until it stops. Pull the face away from the spa.
3. After flushing the bearings inside the body with water, spin the rotating nozzle. It should spin freely. If it does not, place the bearing end in a cup of vinegar (the vinegar will soften any deposits). Let it soak overnight. The next day, flush with water and repeat the spin test.

NOTE: If it still doesn't spin freely, then a second night of soaking is required. Replace the jet if the bearing still does not spin.

4. To replace, position the face body downward and push the face body back into the jet fitting. Slightly rotate face body in either direction until you feel the body align with the fitting, and then press firmly on the face. Once seated, rotate the face clockwise using a little extra force to overcome the locking position. If the face does not rotate, remove and rotate the face 180°, and repeat this step.
5. Turn the jet pump on. The VersaSage jet should spin freely.

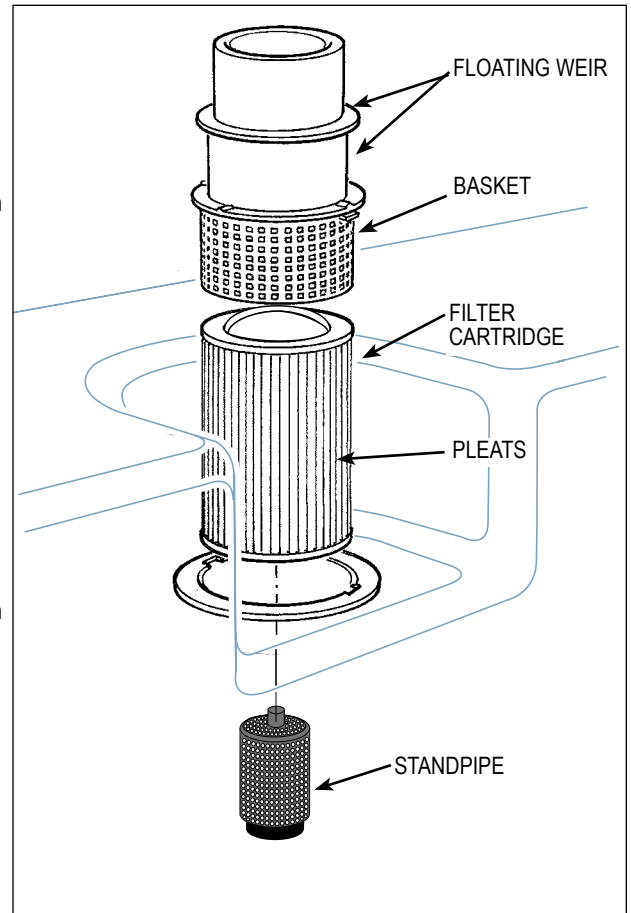

MAINTENANCE

DRAINING YOUR SPA

1. Turn off all GFCI breakers in sub-panel, or main electrical panel.
2. Locate the main drain valve for the spa. Pull on handle (Step 1) until you reach the mid position (Step 2) then rotate handle slightly to fully extended drain tube (drain cap and 1" of the drain tube is exposed) then remove the drain cap (Step 3) . **NOTE:** You will not be able to remove drain cap in mid position. Attach the garden hose to the end of the drain (step 4) making sure not to push the drain tube inward. Route the outlet of the hose to an appropriate draining area.

NOTE: Spa water with a high sanitizer level may harm plants and grass.

3. Push the garden hose and drain tube half way back towards the spa (Step 4) which will start the gravitational flow. Drain tube must be in the mid position for the spa to drain.

IMPORTANT: All models will drain almost completely through the drain valve. Equipment such as the jet pump and heating system will drain. Any water remaining within the plumbing or equipment after draining will only need to be removed if the spa is being winterized.

4. After your spa is empty, clean the shell and filter cartridge.
5. Pull and remove garden hose, replace drain cap and push drain tube back into spa as seen in Step 1.
6. Follow the "START-UP AND REFILL PROCEDURES" to refill your spa.

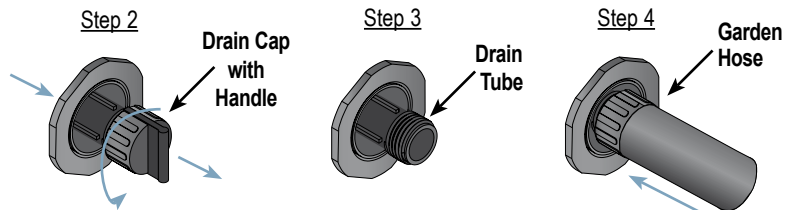
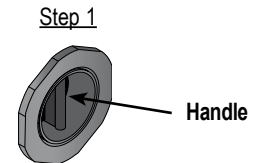
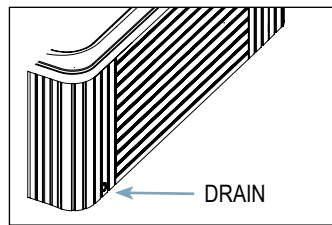

PREVENTION OF FREEZING

Your spa has been designed and engineered for year-round use in any climate. In some areas, extremely cold temperatures (below 10°F) combined with strong wind, may cause partial freezing of the jet pump, even though the water inside the spa remains at the selected temperature. The energy efficiency of the spa may also decrease during these cold periods, as the heater will cycle more frequently. As an additional precaution against partial freezing of some of the components, the equipment compartment can be insulated with an insulating kit (available from your local dealer). This insulating kit will also help to maximize the spa's energy efficiency.

NOTE: When warmer weather returns (approx. 60°-70°F), the insulating kit must be removed to prevent overheating of the jet pump.

WINTERIZING YOUR SPA

If you leave the spa unused for a long period of time in severely cold weather, you should drain the spa and winterize it to avoid accidental freezing due to a power or equipment failure. Follow these directions:

DANGER: Use only Propylene Glycol as your anti-freeze (available at most RV or marine supply stores). This is non-toxic. Never use an automobile anti-freeze (Ethylene Glycol) since it is toxic!

WARNING: Failure to follow these instructions correctly can lead to freeze damage not covered by warranty. It is strongly recommended that you contact your local dealer to perform this service.

1. Drain your spa according to the instructions in the "Draining Your Spa" section in the owner's manual.
2. Remove the filter cartridge, clean and store in a dry place.

IMPORTANT: These additional instructions must be utilized when draining and winterizing your spa in climates where the temperature falls below 32°F (0°C). A five (5) gallon combination (vacuum/blower) wet/dry shop vac must be used to effectively remove water that is trapped inside the plumbing lines.
3. If your spa is equipped with a blower, evacuate water from the air jet lines as follows:
 - a) Turn on the 30A breaker.
 - b) Activate the blower by pushing the air button. Once all water has been evacuated, turn off the blower.
 - c) Turn off the 30A breaker.
4. Attach the vacuum hose to the vacuum side of the shop vac. Vacuum all openings and orifices as follows:
 - a) Jet openings: start with the jets at the top and move downward (if suction is coming from another jet, block off the other jet using a large rag – this will help pull out the water that is trapped deeper inside the main line).
 - b) Filter suction fittings and filter compartment.
 - c) Main drain outlet (it may be necessary to cover the drain grate tightly with a rag when vacuuming the main drain to ensure water is drawn completely from the internal plumbing system).
5. Thoroughly dry the spa shell with a clean towel.
6. Replace the main drain cap.

MAINTENANCE

- Using a long-extension funnel, pour anti-freeze into all standpipes, filter suction fittings, jet orifices and water feature orifices. Also, add anti-freeze to the SPA FROG® canister. Add enough anti-freeze to ensure adequate protection – in many cases, you will see the liquid in the orifice, or coming out of another location.
CAUTION: Use only Propylene Glycol as your anti-freeze. This is non-toxic. Never use an automobile anti-freeze (Ethylene Glycol) since it is toxic!
- Close the spa cover and fasten the cover tie downs. Cover the spa cover with two pieces of plywood to evenly distribute the weight of snow and ice. Secure a plastic sheet, or tarp, over the spa cover and plywood.
- Replace the equipment access door, if removed.

OPENING INSTRUCTIONS:

- Remove plywood and plastic sheet. Open the spa cover by unfastening the cover tie downs.
- Follow the Start-up and Refill Procedures in the Operating Instructions section of the Owner's Manual. Do not install filters to prevent them from exposure to the anti-freeze.
- As part of this process, superchlorinate the spa water by adding three teaspoons of chlorine (sodium dichlor) per 250 gallons of spa water into the filter compartment. This is twice the normal amount of chlorine needed for superchlorination. This extra amount of chlorine is needed to destroy the anti-freeze.
NOTE: A defoamer may be needed to decrease the amount of foam caused by the anti-freeze.
- Drain your spa to ensure removal of anti-freeze. Do not drain water on grass or plants due to excessive chlorine level.
- After the spa has completely drained, re-install your filter and follow the Start-up and Refill Procedures in the Operating Instructions section of the Owner's Manual.
IMPORTANT: Always keep spa covered when not in use, whether it is empty or full.

CARE OF THE SPA PILLOWS

The spa pillows will provide years of comfort if treated with care. They have been positioned above the water level to minimize the bleaching effects of chlorinated water and other spa water chemicals. To extend their life, whenever the spa shell is being cleaned, the spa pillows should be removed and cleaned. Body oils can be removed with a mild soap and water solution. ALWAYS rinse off the spa pillows thoroughly to remove any soap residue. If the spa is not going to be used for a long period of time (that is during a vacation or if the spa is winterized), or when the spa water is being super-chlorinated, the spa pillows should be removed until the next use of the spa.

TO REMOVE AND REPLACE THE SPA PILLOWS:

- Carefully lift one end of the pillow away from the spa shell.
- Continue lifting one end until all pillow retainers are released from the pillow.
IMPORTANT: Just pulling the pillow straight up and out of the shell recess will eventually damage the pillow. This abuse is not covered under warranty.
- To reinstall the spa pillow, remove the insert then carefully bend the pillow slightly to allow one of the pillow retainers to slip into the recess in the back of the pillow.
- Keeping the pillow slightly bent, slide the other pillow retainer into the recess in the back of the pillow.
- After all the pillow retainers are in place, press the pillow down into the recess in the spa shell, then place insert back into center of the pillow.

CARE OF THE EXTERIOR

SPA SHELL

Your Caldera® spa has a granite like or smooth acrylic shell. Stains and dirt generally will not adhere to your spa's surface. A soft rag should easily remove most dirt. Most household chemicals are harmful to your spa's shell. Always use a soft, non-abrasive solution (such as a baking soda and water mix). Never use cleansers with harsh chemicals or acids, such as citrus, alcohol, or ammonia. Damage to your spa shell can occur. Always thoroughly rinse off any spa shell cleaning agent with fresh water.

SERVICE NOTES:

- Iron and copper in the water can stain the spa shell if allowed to go unchecked. Your Caldera Dealer can recommend a stain and scale inhibitor to use if your spa water has a high concentration of dissolved minerals.
- The use of alcohol or any household cleaners other than those listed to clean the spa shell surface is NOT recommended. DO NOT use any cleaning products containing abrasives or solvents since they may damage the shell surface. **NEVER USE HARSH CHEMICALS!** Damage to the shell by the use of harsh chemicals is not covered under the warranty.

IMPORTANT: Some surface cleaners contain eye and skin irritants. Keep all cleaners out of the reach of children and use care when applying.

SPA SKIRT

When cleaning the skirt of your spa, use only a soft cloth or sponge with a mild soap and water solution. The use of an abrasive type cleaner or applicator will be harmful to the exterior finish. Always thoroughly rinse off the spa skirt with fresh water.

WATER QUALITY AND MAINTENANCE

CARE OF THE SPA COVER

⚠ **WARNING:** The cover is a manual safety cover that meets or exceeds all prevailing requirements of ASTM Standards for spa safety covers when installed and used correctly as of the date of manufacture. Non-secured or improperly secured covers are a hazard. Open the cover to its fully open position before use.

VINYL COVER

The vinyl spa cover is an attractive, durable foam insulation product. Monthly cleaning and conditioning are recommended to maintain its beauty.

TO CLEAN AND CONDITION THE VINYL COVER:

1. Remove the cover from the spa and gently lean it against a wall or fence.
2. With a garden hose, spray the cover to loosen and rinse away dirt or debris.
3. Using a large sponge and/or a soft bristle brush and a very mild soap solution (1 teaspoon dishwashing liquid with 2 gallons of water) or baking soda (sodium bicarbonate), scrub the vinyl top in a circular motion. Do not let the vinyl dry with a soap film on it before it can be rinsed clean.
4. Scrub the cover's perimeter and side flaps. Rinse clean with water.
5. Rinse off the underside of the cover with water only (don't use soap), and wipe it clean with a dry rag.

SERVICE NOTE: To remove tree sap, use cigarette lighter fluid (not charcoal lighter fluid). Use sparingly. Rinse with a saddle soap solution immediately afterwards, and then wipe dry.

IMPORTANT REMINDERS:

- **DO** remove snow buildup to avoid breakage of the foam core from the additional weight of the snow.
- **DO** lock cover lock straps to secure the cover when the spa is not in use.
- **DO NOT** drag or lift the spa cover using either the flaps or the cover lock straps.
- **DO NOT** walk, stand, or sit on the cover.
- **DO NOT** place any metal or heat transferring object on the cover or place any type of plastic tarp or drop cloth over the cover as this may result in a melted foam core, which would not be covered under the warranty.
- **DO NOT** use any lifting mechanisms, chemicals or cleaners except those recommended by Watkins Manufacturing Corporation or its Authorized Sales and Service Dealer.

WATER QUALITY AND MAINTENANCE

It's important to have clean water. Water maintenance is one of the least understood, yet most important areas of spa ownership. Your dealer can guide you through the process of achieving and maintaining perfect water in your spa, given your local conditions. Your program will depend on your water's mineral content, how often you use your spa, and how many people use it.

WATER TERMINOLOGY

The following chemical terms are used in this Water Quality and Maintenance section. Understanding their meaning will help you to better understand the water maintenance process.

Bromamines: Compounds formed when bromine combines with nitrogen from body oils, urine, perspiration, etc. Unlike chloramines, bromamines have no pungent odor and are effective sanitizers.

Bromine: A halogen sanitizer that is commonly used in stick, tablet, or granular form. The SPA FROG® sanitizing system is the only solid bromine-approved system. See the DO's and DON'Ts of Spa Water Maintenance for additional information.

Calcium Hardness: The amount of dissolved calcium in the spa water. This should be approximately 150-400 ppm. High levels of calcium can cause cloudy water and scaling. Low levels can cause harm to the spa equipment.

Chloramines: Compounds formed when chlorine combines with nitrogen from body oils, urine, perspiration, etc. Chloramines can cause eye irritation as well as having a strong odor. Unlike bromamines, chloramines are weaker, slower sanitizers.

Chlorine: An efficient sanitizing chemical for spas. Watkins Manufacturing Corporation recommends the use of sodium dichlor-type granulated chlorine. This type is preferred because it is totally soluble and nearly pH neutral.

Chlorine (or Bromine) Residual: The amount of chlorine or bromine remaining after chlorine or bromine demand has been satisfied. The residual is, therefore, the amount of sanitizer which is chemically available to kill bacteria, viruses and algae.

Corrosion: The gradual wearing away of metal spa parts, usually caused by chemical action. Generally, corrosion is caused by low pH or by water with levels of TA, CH, pH or sanitizer which are outside the recommended ranges.

DPD: The preferred reagent used in test kits to measure the Free Available Chlorine.

Halogen: Any one of these five elements: fluorine, chlorine, bromine, iodine, and astatine.

MPS: Monopersulfate is a non-chlorine oxidizer.

Oxidizer: The use of an oxidizing chemical is to prevent the buildup of contaminants, maximize sanitizer efficiency, minimize combined chlorine and improve water clarity.

Ozone: Ozone is a powerful oxidizing agent which is produced in nature and artificially by man. Ozone forms no by-products of chloramines (ozone actually oxidizes chloramines) and will not alter the water's pH.

Pathogen: A microorganism such as bacterium that cause disease.

pH: The measure of the spa water's acidity and alkalinity. The recommended pH for the spa water is 7.2 to 7.8. Below 7.0 (considered neutral), the spa water is too acidic and can damage the heating system. Above 7.8, the water is too alkaline and can result in cloudy water, and scale formation on the shell and heater.

ppm: The abbreviation of "parts per million", the standard measurement of chemical concentration in water. Identical to mg/l (milligrams per liter).

Reagent: A chemical material in liquid, powder, or tablet form for use in chemical testing.

Sanitizer: Sanitizers are added and maintained at recommended residuals to protect bathers against pathogenic organisms which can cause disease and infection in spa water.

Scale: Rough calcium-bearing deposits that can coat spa surfaces, heaters, plumbing lines and clog filters. Generally, scaling is caused by mineral content combined with high pH. Additionally, scale forms more readily at higher water temperatures.

Shock Treatment: Also known as "super-chlorination" when chlorine is used. Shock treatment is a process of adding significant doses of a quick dissolving sanitizer (sodium dichlor is recommended) to oxidize non-filterable organic waste and to remove chloramines and bromamines.

Total Alkalinity: The amount of bicarbonates, carbonates, and hydroxides present in spa water. Proper total alkalinity is important for pH control. If the TA is too high, the pH is difficult to adjust. If the TA is too low, the pH will be difficult to hold at the proper level. The desired range of TA in spa water is 80 to 180 ppm.

GENERAL INFORMATION

THE THREE FUNDAMENTAL AREAS OF WATER MAINTENANCE:

- WATER FILTRATION
- CHEMICAL BALANCE/PH CONTROL
- WATER SANITATION

Water sanitation is the responsibility of the spa owner. To properly sanitize the spa, Watkins highly recommends the SPA FROG® water care system. This system will chemically control the bacteria and viruses present in the fill water or introduced during use of the spa. Bacteria and viruses can grow quickly in undersanitized spa water. The water's chemical balance and pH control are also the responsibility of the spa owner. You'll have to add chemicals to maintain proper levels of Total Alkalinity (TA), Calcium Hardness (CH) and pH. Proper water balance and pH control will minimize scale buildup, extend the life of the spa, and allow the sanitizer to work at an optimum level.

WATER QUALITY AND MAINTENANCE

METHODS FOR TESTING THE SPA WATER

Accurate water testing and analysis is an important part of effectively managing your spa water. You must have the ability to test for:

- Total Alkalinity (TA)
- Calcium Hardness (CH)
- pH
- Sanitizer

Two types of testing methods are recognized and recommended by Watkins Manufacturing Corporation:

1. **The Reagent Test Kit** is a method which provides a high level of accuracy. The reagents come in either liquid or tablet form.
2. **Test Strips** are a convenient testing method used by many spa owners. Keep in mind that test strips are susceptible to heat and moisture contamination, which will result in inaccurate readings.

IMPORTANT: Always read and carefully follow the directions included with the Test Kit or Test Strips to ensure the accuracy of the test results.

BASIC CHEMICAL SAFETY

When using chemicals, read the labels carefully and follow directions precisely. Though chemicals protect you and your spa when used correctly, they can be hazardous in concentrated form. Always observe the following guidelines:

- Allow only a responsible person to handle spa chemicals. **KEEP THEM OUT OF THE REACH OF CHILDREN.**
- Accurately measure the exact quantities specified. Never use more. Do not overdose your spa.
- Handle all containers with care. Store in a cool, dry, well-ventilated place.
- Always replace the caps on their proper containers when not in use.
- Don't inhale fumes or allow chemicals to come in contact with your eyes, nose, or mouth. Wash your hands immediately after use.
- Follow the emergency advice on the product label in case of accidental contact, or if the chemical is swallowed. Call a doctor or the local Poison Control Center. If a doctor is needed, take the product container along with you so that the substance can be identified.
- Don't let chemicals get on surrounding surfaces or landscaping.
- Don't use a vacuum cleaner to clean up chemical spills.
- Never smoke around chemicals. Some fumes can be highly flammable.
- Don't store any chemicals in the spa equipment compartment.

HOW TO ADD CHEMICALS TO THE SPA WATER

IMPORTANT: All spa water chemicals (other than SPA FROG cartridges), including MPS+ (shock), chlorine, granulated pH increaser or decreaser, granulated total alkalinity increaser, calcium hardness increaser, liquid stain and scale inhibitor, and liquid de-foamer must always be added directly into or in front of the filter compartment while a jet pump is running, and it must run for a minimum of ten minutes.

TO ADMINISTER SPA WATER CHEMICALS:

1. Fold back the cover and remove the filter compartment cover.
2. Push the "CLEAN" button to turn on the jet pump.
3. Carefully measure the recommended amount of chemical and slowly pour it over the filter basket area. Use care not to splash chemicals on your hands, in your eyes, on the spa sheet surface, or on the siding.
4. Replace the filter compartment cover. After ten minutes, shut off the jet pump(s) and close the cover. **Risk of Drowning:** Never leave an open spa unattended!

⚠ WARNING: High sanitizer levels can cause discomfort to the user's eyes, lungs and skin. Always allow the sanitizer level to fall to the recommended range before using the spa.

IMPORTANT NOTE ABOUT "SUPER CHLORINATION/NON-CHLORINE SHOCK TREATMENT": After administering a super chlorination treatment or non-chlorine shock to your spa, leave the cover open for a minimum of 20 minutes to allow the oxidizer gas to vent. A high concentration of trapped oxidizer gas which may exist as a result of the shock treatment (not daily sanitation) may eventually cause discoloration or vinyl degradation to the bottom of the cover. This type of damage is considered chemical abuse and is not covered under the terms of the limited warranty.

THE WATKINS SPA WATER MAINTENANCE PROGRAM

Each step in your water maintenance program is dependent on the completion of the previous steps. Omitting a step or failing to reach the recommended range may cause an imbalance in your water's chemistry. Unbalanced water chemistry can damage the spa and its components, as well as cause discomfort for the user.

BALANCING THE TOTAL ALKALINITY (TA)

- A. The recommended Total Alkalinity (TA) for your spa water is 80 - 180 ppm.
- B. Total Alkalinity is a measure of the total levels of carbonates, bicarbonates, hydroxides, and other alkaline substances in the water. TA is referred to as the water's "pH buffer". In other words, it's a measure of the ability of the water to resist changes in pH level.
- C. If the TA is too low, the pH level will fluctuate widely from high to low. Fluctuations in pH can cause corrosion or scaling of the spa components. **Low TA can be corrected by adding sodium hydrogen carbonate (pH/Alkalinity Up).**

WATER QUALITY AND MAINTENANCE

- D. If the Total Alkalinity is too high, the pH level will tend to be high and may be difficult to bring down. **It can be lowered by using sodium bisulfate (pH/Alkalinity Down).**
- E. Once the TA is balanced, it normally remains stable, although the addition of more water with a high or low alkalinity will raise or lower the TA reading of the water.
- F. When the Total Alkalinity is within the recommended range, proceed to the next step.

BALANCING THE CALCIUM HARDNESS (CH)

- A. The recommended Calcium Hardness (CH) level for your spa is 150 - 400 ppm.
- B. Calcium Hardness is a measure of the total amount of dissolved calcium in the water. Calcium helps control the corrosive nature of the spa's water. That's why calcium-low water (commonly known as "soft" water) is not recommended. It is very corrosive to the equipment, and can cause staining of the spa shell.
- C. If the CH is too high (commonly known as "hard water"), formation of scale on the spa's shell surface and equipment can result. **CH can be decreased by dilution—a mixture of 75% hard and 25% soft water will usually yield a reading within the correct range.** If soft water is not available or practical for you, a stain and scale inhibitor should be added to the spa water, according to label instructions.
- D. If the CH is too low add CH Increaser.
- E. Once the CH is balanced, it normally remains stable, although the addition of more water with a high or low calcium content will raise or lower the CH reading of the water.
- F. When the Calcium Hardness is within the recommended range, proceed to the next step.

BALANCING THE PH

- A. The recommended pH level for your spa water is 7.2 - 7.8.
- B. The pH level is the measure of acidity and alkalinity. Values above 7.8 are alkaline; those below 7.2 are acidic. Maintaining the proper pH level is extremely important for:
 - Optimizing the effectiveness of the sanitizer.
 - Maintaining water that is comfortable for the user.
 - Preventing equipment deterioration.
- C. If the spa water's pH level is too low, the following may result:
 - The sanitizer will dissipate rapidly.
 - The water may become irritating to spa users.
 - The spa's equipment may corrode.

ALKALINE SPA WATER (SCALING ZONE)	8.2	ADD pH DECREASER TO LOWER pH
	7.8	
COMFORT ZONE	7.6	IDEAL
	7.4	
	7.2	
ACIDIC SPA WATER (CORROSIVE ZONE)	6.8	ADD pH INCREASER TO RAISE pH
	pH	

If the pH is too low, it can be increased by adding sodium hydrogen carbonate (pH/Alkalinity Up) to the spa water.

- D. If the pH level is too high, the following may result:
 - The sanitizer is less effective.
 - Scale will form on the spa shell surface and the equipment.
 - The water may become cloudy.
 - The filter cartridge pores may become obstructed.

If the pH is too high, it can be decreased by adding sodium bisulfate (pH/Alkalinity Down) to the spa water.

NOTE: After adding sodium hydrogen carbonate or sodium bisulfate, **wait two hours** before testing the water for pH. Measurements taken too soon may not be accurate.

- E. It is important to check the pH on a regular (weekly) basis. The pH will be affected by the bather load, the addition of new water, the addition of various chemicals, and the type of sanitizer used.
- F. When the pH is within the recommended range, proceed to the final step.

MAINTAINING THE SANITIZER LEVEL

- A. Sanitizer is extremely important for killing algae, bacteria and viruses, and preventing unwanted organisms from growing in the spa. At the same time, you don't want too high a sanitizer level, or it can irritate your skin, lungs, and eyes.
- B. Always maintain the sanitizer level in your spa at the recommended level for each type of sanitizer.
- C. Watkins recommends the following sanitizer:
 - SPA FROG sanitizing system (mineral and bromine)
- D. Watkins also approves the following sanitizers:
 - Sodium Dichloro-s-Triazinetrione (sodium dichlor or chlorine)
 - Biguanide

⚠ WARNING: DO NOT use tri-chlor chlorine or any type of compressed bromine or chlorine, acid or any type of sanitizer which is not recommended by Watkins Manufacturing Corporation.

WATER QUALITY AND MAINTENANCE

THE WATKINS WATER MAINTENANCE QUICK REFERENCE GUIDE

Steps	Ideal Range (ppm)		What Chemicals to Use	
	Min.	Max.	To Raise	To Lower
1 Total Alkalinity	80	180	Sodium Hydrogen Carbonate or Sodium Bicarbonate	Sodium Bisulfate
2 Calcium Hardness	150	400	Calcium Hardness Increaser	Use a mixture of 75% hard water and 25% soft water or use a Stain and Scale Inhibitor
3 pH	7.2	7.8	Sodium Hydrogen Carbonate	Sodium Bisulfate
4 Sanitizer	See section on Maintaining the Sanitizer Level			

SPA FROG® WATER CARE SYSTEM

The SPA FROG Water Care system is comprised of the following products:

- **The SPA FROG mineral cartridge** that introduces minerals into the spa water, inhibiting bacteria growth. When combined with Monarch® MPS and MPS Plus, it oxidizes particulates in the spa water.
- **The SPA FROG Bromine (BCDMH)** is the only recommended sanitizer that will work in conjunction with the SPA FROG mineral cartridge in this system.
- **Monarch MPS Plus Non-Chlorine Shock (MPS/Monopersulfate)** is an oxidizing chemical used to prevent the buildup of contaminants, maximize sanitizer efficiency, and improve water clarity.
- **Monarch Corona Discharge (CD) Ozone Generator** (optional on select spas) - The Monarch high output ozone system is the only ozone purification system approved for installation in your Caldera® Spa. The Monarch ozone system utilizes CD technology to produce a higher concentration of ozone than is produced by competing chip style CD or ultraviolet light ozone systems.

NOTE: Refer to your SPA FROG owner's manual for start-up and operation instructions. The owner's manual is included with the SPA FROG starter kit.

It is important to follow the recommended application and maintenance programs outlined for each product's use. If the spa is being used over an extended period of time, such as a whole afternoon or evening, additional sanitizer will be needed.

A weekly "shock treatment" is required. The shock treatment quickly destroys any remaining contaminants while revitalizing the bromine in the water.

To weekly "shock treat" your spa, we recommend that you use either Monarch MPS Plus (sodium dichlor may also be used). Sodium dichlor may be a more appropriate weekly shock for those users that experience heavy bather load conditions.

IMPORTANT NOTE: Monarch MPS Plus is an oxidizer, not a sanitizer.

SPA FROG CARTRIDGE REPLACEMENT INSTRUCTIONS

The SPA FROG bromine cartridge should be replaced every 2-4 weeks, depending on User Load. The SPA FROG mineral cartridge should be replaced every 4 months. When replacing the mineral cartridge, it is highly recommended that the spa be drained and refilled at the same time. After refilling the spa with water, balance the Total Alkalinity (TA), Calcium Hardness (CH) and pH to the recommended levels. Shock the spa by adding Monarch MPS+ non-chlorine shock.

To replace SPA FROG cartridges, follow these steps:

1. Turn off power to the spa.
2. Unscrew SPA FROG cap on top edge of spa.
3. Turn handle counter-clockwise.
4. Lift cartridge holder up and out of spa.
5. Turn top cap of mineral cartridge to setting #6. (The mineral cartridge should last 4 months.) Turn top cap of bromine cartridge to setting #7.

NOTE: Adjust bromine cartridge setting down by one setting each day until a residual of 1.0 - 2.0 ppm level of bromine is established. (The bromine cartridge should last 2 - 4 weeks.)

6. Snap bromine cartridge in at bottom of holder and mineral cartridge on top.

NOTE: It is important that the bromine cartridge is on bottom; otherwise, the bromine cartridge could be dispensed prematurely.

7. Reinstall cartridge holder into spa, push down, and twist clockwise.
8. Replace SPA FROG cap.
9. Reconnect power to the spa.

WARNING: High sanitizer levels can cause discomfort to the user's eyes, lungs and skin. Always allow the sanitizer level to fall to the recommended range before using the spa.

WATER QUALITY AND MAINTENANCE

FOLLOWING THE SPA FROG® SANITIZER ROUTINE

During the first month of ownership, measure the sanitizer residual daily in order to establish the correct setting on cartridges for User Load and Usage Time versus Sanitizer Needed.

- The User Load of the spa is the number of times anyone enters the spa.
- The Usage Time is simply the amount of time a user spends in the spa.
- Sanitizer Needed is the amount needed to accommodate the number of users and their combined usage time.

For example, two spa users who regularly use the spa once an evening for twenty minutes create a specific and somewhat consistent demand on the sanitizer. During the first month of ownership, these two users can determine exactly how much sanitizer to use in order to maintain the proper residual. If, at any time, the user load and/or usage pattern changes dramatically (i.e. invited guests), the amount and frequency of sanitizer required increases dramatically. The greater the usage time, or the bather load, the faster the residual value is diminished.

DOS AND DON'TS

- **DO check your bromine chemical level prior to each use.**
- **DO change the SPA FROG mineral cartridge every 4 months.**
- **DO test Total Alkalinity and pH weekly.**
- **DO use Monarch® MPS+ non-chlorine (Monopersulfate) oxidizer for spas only.**
- **DO store all chemicals in a tightly sealed container in a cool, dry place.**
- **DON'T use sodium bromide or biguanides. These are active sanitizers, and combining with the silver ions will inactivate them.**
- **DON'T use a water clarifier; clarifiers will cause the spa water to become cloudy.**
- **DON'T use the Monarch silver cartridge with SPA FROG.**

BROMINE

- Sanitizing chemicals, such as bromine, are oxidants that kill bacteria and viruses in the water. If you are using the SPA FROG system, the recommended bromine level for your spa water is 1.0 - 2.0 ppm. If you are not using the SPA FROG system, your bromine level should be between 3 - 5 ppm.
- Watkins Manufacturing Corporation recommends the use of granulated bromine for sanitizing the water. Granulated bromine is preferred because it is totally soluble, dissolves quickly and is nearly pH neutral.
- Maintaining the proper level of bromine during use is extremely important.
- If the bromine level is too low, bacteria and viruses can grow rapidly in the warm water.
- If the bromine level is too high, the water can cause discomfort to the user's eyes, lungs and skin. **Simply allow some time to pass.**
- When the bromine level is within the recommended range, the spa is ready to be enjoyed.

SUPER CHLORINATION

Super Chlorination is a process used to eliminate chlorine smell (if you are using chlorine) by "burning-off" chloramines (used chlorine). This helps maintain the proper level of free chlorine.

When giving your water a super chlorination treatment, open the cover at least half way for twenty minutes to allow the chlorine gas to vent off. The high concentration of chlorine gas which may exist as a result of super chlorination (not daily sanitation) may eventually cause discoloration or degradation to the bottom of the cover, which would not be covered under the terms of your warranty.

WARNING: There are several forms of stabilized chlorine available for use in spas and swimming pools. Each form has specific chemical characteristics. It is extremely important that the form you choose is specifically designed for use in spas. Use of an incorrect product such as tri-chloro, which has a very low pH (2.6), dissolves too quickly in hot water resulting in extremely high levels of chlorine, and is designed for concrete or plaster swimming pools, WILL cause damage to your spa. Use of a liquid, or any type of compressed bromine or chlorine, acid, or any type or sanitizer which is not recommended by Watkins Manufacturing Corporation, WILL damage your spa and is specifically not covered under the terms of the limited warranty.

IMPORTANT: Granulated chlorine (sodium dichlor) will degrade if stored improperly. We recommend purchasing chlorine in one, two, or five pound containers and storing it in a cool, dry place to maintain its potency.

WARNING: Never leave an open spa unattended, especially if there are children present!

CHLORINE DPD TEST KIT OR TEST STRIP READING	DO NOT USE THE SPA UNTIL THE TEST KIT READING IS BELOW THIS LEVEL
5.0	RECOMMENDED LEVEL SAFE
4.0	
3.0	ADD CHLORINE
2.0	DO NOT USE SPA ; ADD CHLORINE TO REACH RECOMMENDED SAFE LEVEL
1.0	
0	

WATER QUALITY AND MAINTENANCE

WATKINS WATER TREATMENT GUIDE

At spa startup or refill	Follow spa Start-Up and Refill Procedures.
Prior to each use (Test before adding any chemicals; do not add any chemicals if proper or higher levels are found.)	Add one (1) tablespoon of Monarch® MPS Plus (monopersulfate)* per 250 gallons.
Once a week	Add three (3) tablespoon Monarch MPS Plus (monopersulfate)* per 250 gallons.
Every four months	Drain spa, replace mineral cartridge, and refill your spa. Follow spa Start-Up and Refill Procedures.
If needed (If water is hazy, cloudy or has an odor)	Add one and one half (1-1/2) teaspoons of sodium dichlor per 250-gallons, as needed.

* Monarch MPS Plus is an oxidizer, not a sanitizer

SUPPLEMENTAL WATER MAINTENANCE

Proper water sanitation and mineral balance (pH control) are absolutely essential for a complete spa water maintenance program. Here are two other popular water additives that are optional:

1. MINERAL DEPOSIT INHIBITORS

As water evaporates from your spa and new water is added, the amount of dissolved minerals will increase. (Minimize evaporation by keeping the cover on the spa whenever possible.) The spa water may eventually become "hard" (Calcium Hardness too high) enough to damage the heater by calcifying its surface. Proper pH control can minimize this.

Normal soap build-up will require water replacement regularly enough that mineral deposits normally are not a problem.

Occasionally, high iron or copper content in the water may produce green or brown stains on the spa. A stain and scale inhibitor may help to reduce these metals.

NOTE: Well water may contain high concentrations of minerals. The use of a low water volume, extra-fine pore water filter will help to remove many of the larger particles during the filling of the spa.

2. FOAM INHIBITORS

Spa water requires changing due to the buildup of soap in the water. Typically, soap will cause the spa water to foam when the jets are used. Soap is introduced into the spa water from two sources: users' bodies, which retain a soap residue after showering, and swimming apparel, which retains soap after washing.

Foam inhibitors can suppress foam, but cannot remove soap from the water. Soap is very difficult to remove from the water because soap is not oxidized by any chemical added to the spa. Only ozone can oxidize soap.

Eventually the soap build-up in the water will be concentrated, resulting in an unclean feeling on the bather's skin, which is impossible to remedy. When this occurs, it's time to drain and refill the spa. Depending on the soap input, the water should last about 4 months before needing to be drained.

MONARCH® OZONE SYSTEM (OPTIONAL)

The Monarch high output ozone system is the only ozone purification system approved for installation in your Caldera® Spa. The Monarch ozone system utilizes Corona Discharge (CD) technology to produce a higher concentration of ozone than is produced by competing ultraviolet light (UV) ozone systems.

The Monarch high output ozone system greatly enhances the quality of the spa water when used to supplement the spa owner's regular water maintenance program. Contrary to some information circulated throughout the pool and spa industry regarding ozone systems, ozone **CANNOT** be used as a single-source sanitizer, water clarifier, anti-foamer, and mineral chelating agent. Watkins Manufacturing Corporation recommends following the SPA FROG® sanitizing system when using an ozone purification system to assure water sanitation and the highest quality of purified water.

CLEANING THE OZONE INJECTOR

On occasion, a mineral build up may clog the ozone injector, causing a lack of flow or low flow, of ozone bubbles. To prevent this, refer to the following instructions to clean the injector:

1. Disconnect power to the spa.
2. Access the equipment compartment.
3. Place 16 ounces of white vinegar into a container such as a cup or bucket. Place the container on the equipment compartment floor.

NOTE: White vinegar will not damage any of the spa components.

4. Carefully loosen the long tubing to the bottom of the ozonator. **A liquid substance may be found inside the tubing. If a liquid substance is present, BE CERTAIN NOT TO COME INTO CONTACT WITH THE LIQUID (SEE WARNING ON NEXT PAGE).**



WATER QUALITY AND MAINTENANCE

5. Place the end of the tubing into the vinegar, making certain that the end of the tubing sits at the bottom of the container.
6. Reconnect power to the spa.
7. Run the spa until all 16 ounces of the vinegar are gone. This should allow an ample flow of vinegar to be run through the injector and clear the blockage.
8. Disconnect power to the spa.
9. Remove the empty cup or bucket.
10. Reinstall the tubing to the bottom of the ozonator.
11. Close the equipment compartment door.
12. Reconnect power to the spa.

The Monarch ozone system is practically maintenance-free because it is located within the spa's equipment compartment. If bubbles are appearing at the spa's heater return, but the water is not as clear as usual, then the operation of the ozone generator should be checked your Caldera® Spa Dealer.

WARNING: Contact your Caldera Spa Dealer if your spa requires troubleshooting beyond the scope of this manual. Monarch ozone systems should only be serviced by a qualified technician.

WARRANTY NOTE: Cleaning of the ozone injector is not covered under the warranty. Refer to the Ozone section of this manual for ozone injector cleaning instructions.

 <p>WARNING</p>	<p>NITRIC ACID ACCUMULATES IN THE AIR LINES OF THE OZONATOR AND INJECTOR. NITRIC ACID WILL CAUSE SEVERE CHEMICAL BURNS IF DIRECT SKIN CONTACT IS MADE, SO ALWAYS WEAR PROTECTIVE GLOVES, GLASSES AND CLOTHING WHEN WORKING ON THE OZONATOR OR INJECTOR LINES. TO PREVENT INHALATION OR INGESTION OF THE NITRIC ACID, DO NOT BLOW OR INHALE WITH YOUR MOUTH TO ANY OF THE ADAPTERS, FITTINGS OR TUBING OF THE OZONATOR OR INJECTOR AIR LINES.</p>	 <p>WARNING</p>
---	---	---

DOS AND DON'TS

- DO add all chemicals slowly into or in front of the filter compartment with the jet pump operating for ten minutes.
- DO use special care if using baking soda to clean either the interior or exterior plastic surfaces.
- DO use only a granular form of bromine sanitizer.
- DON'T use swimming pool (muriatic) acid to lower pH.
- DON'T splash pH increaser additives on the siding.
- DON'T use Compressed Sanitizers.
The use of bromine sticks or tablets in floaters, which may become entrapped in a lounge or cooling seat (or sink to the spa floor), have been shown to cause discoloration of or surface distress to a spa's shell.
- DON'T use a floater type sanitization system as a low or no maintenance solution to your spa maintenance program.
Floating dispensers can become trapped in one area and cause an over-sanitization (or chemical burn) of that particular area.
If the dispenser setting is too high, the high concentration can discolor the spa shell and damage the underside of the cover.
Automatic floating dispensers have a tendency to either over-brominate or under-brominate as the rate of erosion varies greatly. Damage to the spa and cover can occur very quickly.
IMPORTANT: Watkins Manufacturing Corporation does not recommend the use of any floating chemical dispenser. Damage to the spa shell or components caused by a floating chemical dispenser is specifically not covered under the terms of the limited warranty.
- DON'T use a sanitizer which is not designed for spas.
- DON'T use household bleach (liquid sodium hypochlorite).
- DON'T broadcast or sprinkle the chemicals onto the water surface. This method may cause chemically-induced spa surface blistering (chemical abuse).

MONARCH SILVER ION PURIFIER (OPTIONAL)

Question: How are the silver ions added to the water?

Answer: The silver cartridge contains ceramic beads that are infused with silver. By placing the cartridge in the holder filter standpipe, it is subject to the flow of water created by the operation of the 24-hour EnergyPro® circulation pump. The flowing water, through a chemical erosion process, carries with it the silver ions necessary to add a sanitizing residual to the spa water.

Question: What happens if I do not add the weekly shock treatment?

Answer: The contaminants in the water may coat the silver cartridge's ceramic beads, blocking the silver ions' release into the water. When this occurs, there will be no residual of silver ions present in the water, eliminating them from the sanitizing process.

Question: How often should the Monarch silver cartridge be replaced?

Answer: The cartridge must be replaced every four months. Please refer to the instructions provided with each SPA FROG silver cartridge.

Question: Can I use the Monarch silver cartridge with the SPA FROG® water care system?

Answer: The Monarch silver cartridge is not compatible with SPA FROG or with bromine.

WATER QUALITY AND MAINTENANCE

COMMON WATER CHEMISTRY QUESTIONS

Question: Why is the use of a floater not recommended to sanitize my spa water?

Answer: Watkins Manufacturing Corporation does not recommend the use of a floater for three reasons:

1. The floater is unable to control the rate at which the sanitizer is dissolved into the water. When a floater is first placed in a spa, the sanitizer level can be extremely high. High sanitizer levels can chemically burn or discolor the spa's shell or the underside of the cover. Then, after a period of time, the sanitizer level dispensed by the floater will fall to near zero. A low sanitizer level will allow viruses, bacteria or algae to grow.
2. Floaters tend to stay in one area of the spa most of the time, causing this area to be exposed to extreme sanitizer levels.
3. The floater may allow pieces of the highly concentrated sanitizer to fall out and settle on the floor or seat of the spa shell. These pieces of sanitizer will chemically burn (blister) the spa shell. Although your spa shell is specifically designed to resist the effects of spa chemicals, no spa surface can withstand this type of highly concentrated chemical. Remember, chemical abuse is specifically not covered under the terms of the warranty.

Question: When I open my spa, I smell chlorine. How do I get rid of this smell?

Answer: There are two types of chlorine in your spa. The first is the Free Available Chlorine, which is the chlorine available to sanitize your spa. This Free Available Chlorine does not have an odor. The second is Chloramine, which is residue from chlorine already expended. Chloramines have a strong chlorine odor. The smell from Chloramines can be eliminated by "shocking" the water. If you smell chlorine in the water, your spa is reminding you to add a shock treatment.

Question: Why can't I fill my spa with soft water?

Answer: Soft water is essentially the same as regular water, except that most or all of the calcium has been replaced by sodium. Soft water may be corrosive to the heater and other components. Replacement of spa components damaged by soft water is extremely expensive.

Question: I am trying to reduce the number of chemicals to which my family is exposed. Do I really need to use so many chemicals and in such large amounts?

Answer: While over-exposure to any chemical can be unhealthy, many low levels of chemicals are effective and beneficial. In the case of spa water, the chemicals recommended in the Caldera[®] Spa Water Maintenance program are needed to protect the user from water-borne pathogens (disease-causing microbes) and to prevent corrosion of spa components.

Question: Why isn't water chemistry damage covered by the warranty?

Answer: The chemical levels and water quality of the water in the spa are under your direct control. With proper basic care, the spa will provide many years of hot water relaxation. If you are unsure about any chemical or its usage in the spa, contact your Authorized Caldera Dealer or Watkins Manufacturing Corporation.

SPA WATER MAINTENANCE TROUBLESHOOTING GUIDE

PROBLEM	PROBABLE CAUSES	SOLUTIONS
Cloudy Water	<ul style="list-style-type: none"> • Dirty filters • Excessive oils / organic matter • Improper sanitization • Suspended particles / organic matter • Overused or old water 	<ul style="list-style-type: none"> • Clean filters • Shock spa with sanitizer • Add sanitizer • Adjust pH and/or alkalinity to recommended range • Run jet pump(s) and clean filters • Drain and refill the spa
Water Odor	<ul style="list-style-type: none"> • Excessive organic in water • Improper sanitization • Low pH 	<ul style="list-style-type: none"> • Shock spa with sanitizer • Add sanitizer • Adjust pH to recommended range
Chlorine Odor	<ul style="list-style-type: none"> • Chloramine level too high • Low pH 	<ul style="list-style-type: none"> • Shock spa with sanitizer • Adjust pH to recommended range
Musty Odor	<ul style="list-style-type: none"> • Bacteria or algae growth 	<ul style="list-style-type: none"> • Shock spa with sanitizer – if problem is visible or persistent, drain, clean and refill the spa
Organic buildup / scum ring around spa	<ul style="list-style-type: none"> • Buildup of oils and dirt 	<ul style="list-style-type: none"> • Wipe off scum with clean rag – if severe, drain the spa, use a spa surface and tile cleaner to remove the scum and refill the spa
Algae Growth	<ul style="list-style-type: none"> • High pH • Low sanitizer level 	<ul style="list-style-type: none"> • Shock spa with sanitizer and adjust pH • Shock spa with sanitizer and maintain sanitizer level
Eye Irritation	<ul style="list-style-type: none"> • Low pH • Low sanitizer level 	<ul style="list-style-type: none"> • Adjust pH • Shock spa with sanitizer and maintain sanitizer level
Skin Irritation / Rash	<ul style="list-style-type: none"> • Unsanitary water • Free chlorine level above 5 ppm 	<ul style="list-style-type: none"> • Shock spa with sanitizer and maintain sanitizer level • Allow free chlorine level to drop below 5 ppm before spa use
Stains	<ul style="list-style-type: none"> • Total alkalinity and/or pH too low • High iron or copper in source water 	<ul style="list-style-type: none"> • Adjust total alkalinity and/or pH • Use a metal deposit inhibitor
Scale	<ul style="list-style-type: none"> • High calcium content in water – total alkalinity and pH too high 	<ul style="list-style-type: none"> • Adjust total alkalinity and pH – if scale requires removal, drain the spa, scrub off the scale, refill the spa and balance the water

SERVICE

MISCELLANEOUS SERVICE INFORMATION

The control and high limit thermostats are equipped with electronic sensors that are connected to the spa's plumbing. Never cut, or kink the wires that connect the sensors to the thermostats within the control box.

The jet pump is equipped with a thermal overload cutoff switch that is designed to protect the pump from overheating. If the pump shuts itself off in an older spa, it could indicate failure of the pump motor bearings. If the pump shuts itself off in a new spa, it is usually the result of one or a combination of the following factors:

- **High Temperature:** All Caldera® spa models are equipped with a jet pump shroud that vents the heat generated by the pump motor to the outside of the equipment compartment. If the vent is blocked by masonry, grass, or debris, overheating of the jet pump may occur. Once the pump motor has cooled sufficiently and any blockage has been removed from the vent opening, the jet pump can be restarted.
- **Improper Wiring:** If the spa is connected with an extension cord, and/or the house wiring is undersized, the pump may starve for voltage and therefore may draw more amperage and generate excessive heat.
- If the pump is shutting down due to excessive heat, make sure the equipment compartment has adequate ventilation. The air gap at the bottom must not be blocked. If your jet pump continues to shut off after short periods of use, contact a qualified service technician.

ACTS INVALIDATING WARRANTY

The limited warranty is void if the Caldera spa has been improperly installed, subjected to alteration, misuse, or abuse, or if any repairs on the spa are attempted by anyone other than an authorized representative of Watkins Manufacturing Corporation. Alteration shall include any component or plumbing change, electrical conversion, or the addition of any non-approved sanitation or water purification device or heating system which contributes to component or unit failure or unsafe operating system. Misuse and abuse shall include any operation of the spa other than in accordance with Watkins Manufacturing Corporation printed instructions, or use of the spa in an application for which it is not designed; specifically: use of the spa in a non-residential application; damage caused by operation* of the spa at water temperatures outside the range of 35°F and 120 °F; damage caused by a dirty, clogged or calcified filter cartridge; damage to the spa surface caused by the use of tri-chloro chlorine, BCDMH, misuse of chemical tablets in a floater, acid, or any other spa chemicals or spa surface cleaners which are not recommended by Watkins Manufacturing Corporation; damage caused by allowing undissolved spa sanitizing chemicals to lie on the spa surface (no spa surface material can withstand this kind of abuse); damage to components or spa surface caused by improper water chemistry maintenance; and damage to the spa surface caused by leaving the spa uncovered while empty of water and in direct exposure to sunlight (this may cause solar heating distress in warm weather regions). These are considered abuses and may invalidate this warranty.

*Operation of the spa does not mean "use" of the spa! Watkins Manufacturing Corporation does not recommend using the spa if the water temperature is above or below the spa's control panel temperature range.

DISCLAIMERS

Watkins Manufacturing Corporation shall not be liable for loss of use of the Caldera spa, or other incidental, consequential, special, indirect, or punitive costs, expenses or damages, which may include but are not limited to the removal of a permanent deck or other custom fixture, or the necessity for crane removal. Any implied warranty shall have a duration equal to the duration of the applicable limited warranty stated above. Some states do not allow limitations on how long an implied warranty lasts. Under no circumstances shall Watkins Manufacturing Corporation or any of its representatives be held liable for injury to any person or damage to any property, however arising.

Some states do not allow the exclusion or limitation of incidental or consequential damages, so the above limitations may not apply to you.

WATKINS CUSTOMER SERVICE

If you have any questions about any aspect of your Caldera spa set-up, operation, or maintenance that have not been answered by this manual, consult your Caldera dealer.

Watkins Manufacturing Corporation can be reached at: 800-669-1881 (Extension 8432), Monday through Friday, 8 am to 5-pm Pacific Standard Time (PST), or e-mail custsvc@watkinsmfg.com

SPA TROUBLESHOOTING

If your spa doesn't seem to be working the way you believe it should, please review the "start-up" and "operation" instructions in this manual. If this doesn't help you correct the problem, follow the appropriate instructions below. If the problem is still not resolved, call your Caldera® dealer.

GENERAL OPERATION TROUBLESHOOTING GUIDE

PROBLEM	PROBABLE CAUSES	SOLUTIONS
Entire spa is inoperative.	<ul style="list-style-type: none"> • Power failure • GFCI tripped • Heater high limited thermostat tripped • Spa Lock activated 	<ul style="list-style-type: none"> • Check power source • Reset GFCI; call for service if it will not reset. • Disconnect power for at least thirty seconds to reset heater high limit. If it will not reset, check for clogged filters. If tripping continues, call for service. • Deactivate Spa Lock
Jets weak or surging	<ul style="list-style-type: none"> • Spa water level too low • Filter clogged • Air valves are closed 	<ul style="list-style-type: none"> • Add water • Clean filter • Open air valves
Light inoperative	<ul style="list-style-type: none"> • Spa Lock activated • Light assembly is faulty 	<ul style="list-style-type: none"> • Deactivate Spa Lock • Call for service
Flashing "TEMP" on main control panel	<ul style="list-style-type: none"> • Dirty filter • Low water level • Pressure switch problem • Temperature sensor problem 	<ul style="list-style-type: none"> • Clean filter • See Start Up section in Owner's Manual • Disconnect power for at least thirty seconds. If flashing continues after power up, call for service
Four flashing lines on the main control panel	<ul style="list-style-type: none"> • Heater high limit thermostat tripped 	<ul style="list-style-type: none"> • Disconnect power for at least thirty seconds to reset heater high limit. If it will not reset, check for clogged filter. If tripping continues, call for service
Spa not heating properly	<ul style="list-style-type: none"> • Temperature set too low • Spa cover improperly positioned • Dirty filter • Summer Timer on 	<ul style="list-style-type: none"> • Set control panel to a higher temperature. • Align spa cover • Clean filter • Turn summer timer mode to off position
Pump motor will not function	<ul style="list-style-type: none"> • Motor overload condition • Control switch failure if jet symbol does not come on 	<ul style="list-style-type: none"> • Let cool for one hour. Motor overload will reset automatically. If problem persists, contact your Caldera dealer • Disconnect spa and contact your Caldera dealer
Noisy pump or motor	<ul style="list-style-type: none"> • Low water level 	<ul style="list-style-type: none"> • Add water to normal level (1 inch above highest jet)
Pump motor runs, but low or no water/jet pressure	<ul style="list-style-type: none"> • Air control valve closed or blocked • Low water level • Dirty filter cartridge • Jet blocked • Clogged suction or skimmer basket 	<ul style="list-style-type: none"> • Open or clean air valve • Add water to normal level (1 inch above highest jet) • Clean filter cartridge • Remove jet face eyeball and clean orifice • Clean suction cover or skimmer basket
Diverter valves are difficult to turn	<ul style="list-style-type: none"> • Sand or grit inside valves 	<ul style="list-style-type: none"> • Clean and lubricate valve per diverter valve maintenance instructions
After filling or refilling the spa: a jet pump is operating, but water is not flowing from any of its jets.	<ul style="list-style-type: none"> • Pump is not properly primed. 	<ol style="list-style-type: none"> 1. Turn off power to the spa at the breaker and remove the equipment compartment door (see the "Draining Your Spa" section for illustration). 2. Loosen the union on the top of the pump(s) (see the "Winterizing Your Spa" section for illustration) to allow the air to escape, and then hand-tighten the union(s). 3. Turn power back on, activate the pump, and check to make sure the union is tight enough to keep it from leaking. Replace the equipment doors. <p>OR: Remove and reinstall the SPA FROG® cap.</p>

Comfort Guard[®]

L I M I T E D W A R R A N T Y

Utopia and Paradise Series Spas

Watkins Manufacturing Corporation (“Watkins”) warrants to the original consumer purchaser (“you”) the following about your new Utopia or Paradise Series spa, when purchased from an authorized dealer/service provider (“dealer”).

10 YEAR NO LEAK SHELL WARRANTY

Watkins warrants against water loss due to defects in the Utopia and Paradise series spa shell for ten years.

7 YEAR SHELL SURFACE WARRANTY

Watkins warrants the acrylic surface material of the Utopia and Paradise Series spas to be free from defects in materials and workmanship for seven years.

5 YEAR NO LEAK PLUMBING WARRANTY

Watkins warrants the Utopia and Paradise Series spas against leaks caused by defects in manufacturing and workmanship for five years. This warranty specifically covers leaks from the wall fittings, jet fittings, internal plumbing, internal glue joints, drains, hoses, and all bonded parts.

5 YEAR COMPONENT WARRANTY

Watkins warrants the electrical components, pump(s), and other Utopia and Paradise Series spa components against defects in materials and workmanship for five years. Some parts, most of which can be changed out without the use of tools, such as filter cartridges, filter lid, spa pillows, and cover locks are not included in this warranty, but are warranted to be free from defects in materials and workmanship at the time of delivery. Spa covers and other spa accessories are specifically excluded from this warranty, although they may be covered under other warranties. Please check with your Caldera[®] dealer for details.

5 YEAR ENERGYPRO[®] HEATER WARRANTY

Watkins unconditionally warrants the EnergyPro heater to be free from defects in materials and workmanship for five years. This warranty defines unconditional, with the exclusion of commercial or industrial use, and improper installation, as warranty coverage without exception provided that the component has failed to operate properly within the spa’s system.

3 YEAR ECOTECH[®] CABINET WARRANTY

Watkins warrants the EcoTech simulated wood cabinet material to be free from defects in materials and workmanship for three years. This warranty specifically covers the cabinet’s structural integrity (exclusive of surface stain), including the material and assembly.

The EcoTech cosmetic finish is warranted to be free from defects in materials and workmanship at the time of initial delivery. Fading and weathering of the surface may naturally occur over time and are not considered defects. To restore the EcoTech cabinet’s appearance, refer to the spa Owner’s Manual for proper care and maintenance instructions.

3 YEAR ULTRAMASSEUSE[™] SYSTEM WARRANTY

Watkins warrants the factory-installed UltraMasseuse control system to be free from defects in material and workmanship for three years.

The pressure switch and cable are warranted for one year.

1 YEAR MONARCH[®], SPAGLO[®], SPA FROG[®] AND STEREO WARRANTY

Watkins warrants the factory-installed Monarch ozone, SpaGlo system, Automated SPA FROG System, and the factory installed Aquatic Melodies sound system, which includes the stereo, and/or wireless components, speakers and amplifier to be free from defects in materials and workmanship for one year.

EXTENT OF WARRANTY

This warranty extends only to the original consumer purchaser of the Caldera spa when purchased and originally installed within the boundaries of the United States. This warranty begins on your delivery date of the spa. This warranty terminates upon any transfer of ownership, or if the spa is installed or relocated outside the boundaries of the United States by the original consumer purchaser prior to the expiration of the warranty period.

WARRANTY PERFORMANCE

To make a claim under this warranty, contact your dealer. In the event you are unable to obtain service from the dealer, please contact Watkins Manufacturing Corporation, 1280 Park Center Drive, Vista, California, 92081, Attn: Customer Service Department (800) 669-1881 or via e-mail, custserv@watkinsmfg.com. You must give Watkins and/or your dealer written notice of any warranty claim, along with a copy of your original purchase receipt indicating the date of the purchase, within ten (10) days of the time you discover the claim. Watkins reserves the right to inspect the malfunction or defect on location.

Watkins or its Authorized Service Agent will repair any defects covered by this warranty. Except as described herein, you will not be charged for parts, labor or the freight costs for parts necessary to repair the spa for defects covered by this warranty. In some cases, the servicing dealer may charge you a reasonable repairperson travel/service charge that is not covered by this warranty. Please contact the dealer for information regarding any such charges.

LIMITATIONS

Except as described above, this warranty does not cover defects or damage due to normal wear and tear, improper installation, alteration without Watkins’ prior written consent, accident, acts of God, misuse, abuse, commercial or industrial use, use of an accessory not approved by Watkins, failure to follow Watkins’ Pre-Delivery Instructions or Owner’s Manual, or repairs made or attempted by anyone other than an authorized representative of Watkins. Alteration includes, but is not limited to, any component or plumbing change, or electrical conversion. Visit www.calderaspas.com or contact your dealer for a list of manufacturer approved accessories.

DISCLAIMERS

TO THE EXTENT PERMITTED BY LAW, WATKINS SHALL NOT BE LIABLE FOR LOSS OF USE OF THE SPA OR OTHER INCIDENTAL OR CONSEQUENTIAL COSTS, EXPENSES, OR DAMAGES, INCLUDING BUT NOT LIMITED TO THE REMOVAL OF ANY DECK OR CUSTOM FIXTURE OR ANY COST TO REMOVE OR REINSTALL THE SPA, IF NEEDED. Some states do not allow the exclusion or limitation of incidental or consequential damages, so the above limitations may not apply to you. ANY IMPLIED WARRANTIES, INCLUDING THE IMPLIED WARRANTIES OF MERCHANTABILITY AND FITNESS FOR A PARTICULAR PURPOSE, ARE LIMITED TO THE DURATION OF THE APPLICABLE WARRANTY STATED ABOVE. Some states do not allow limitations on how long an implied warranty may last, so the above limitations may not apply to you.

LEGAL REMEDIES

This warranty gives you specific legal rights, and you may have other rights which vary from state to state.



NOTES

NOTES

PARADISE SERIES SPA SPECIFICATIONS

	Footprint dimensions	Height	Effective filter area	Heater (Watts)	Water capacity	Dry weight	Filled weight*	Dead weight	Electrical Requirements
Moorea® (MOA)	7'0" x 7'7"	36"	75 square feet	4,300	420 gallons	870 lbs.	5,490 lbs.	115 lbs. per square foot	230 volt, 30 or 50 amp Single phase GFCI protected circuit
Hawaiian (HAA)	7'0" x 7'0"	36"	75 square feet	4,300	380 gallons	800 lbs.	5,180 lbs.	110 lbs. per square foot	230 volt, 30 or 50 amp Single phase GFCI protected circuit
Martinique® (MRA)	7'5" x 6'4"	34"	50 square feet	4,300	320 gallons	710 lbs.	4,420 lbs.	100 lbs. per square foot	230 volt, 30 or 50 amp Single phase GFCI protected circuit
Kauai® (KAA)	7'0" x 5'5"	29"	50 square feet	4,300	200 gallons	610 lbs.	2,795 lbs.	95 lbs. per square foot	230 volt, 30 or 50 amp Single phase GFCI protected circuit

CAUTION: Watkins Manufacturing Corporation suggests a structural engineer or contractor be consulted before the spa is placed on an elevated deck.

* **NOTE:** The "Filled weight" and "Dead weight" of the spa includes the weight of the occupants (assuming an average occupant weight of 175 lbs).

This manual contains installation, operating, maintenance and service information for the following Caldera® Spa models:

MODELS	EFFECTIVE DATE
MOOREA	1/09
HAWAIIAN	1/09
MARTINIQUE	1/09
KAUAI	1/09



©2009 Watkins Manufacturing Corporation. Caldera Spas, Moorea, Martinique, Kauai, Monarch, SpaGlo, Advent, EnergyPro, Pure Comfort, EcstaSeat, Euro-Pulse, VersaSsage, OrbiSsage, UltraMassage, LumbarSsage, Sole Soothers, and Euphoria are trademarks of Watkins Manufacturing Corporation. BaquaSpa is a trademark of Arch UK Biocides Limited, Inc. Windex® is a trademark of S.C. Johnson & Son, Inc. Soft Scrub® is a trademark of The Clorox Company. SPAFROG is a registered trademark of King Technologies. Soft Soak is a registered trademark of BioLab, Inc.



Watkins Manufacturing Corporation
Vista, California
USA