

PARADISE™ SERIES

2 0 1 5 O W N E R ' S M A N U A L



CalderaSpas®

WELCOME



Watkins Manufacturing Corporation congratulates you on your decision to enjoy the finest spa available... Welcome to the growing family of Caldera® Spa owners.

OWNER'S MANUAL

This Owner's Manual will acquaint you with the operation and general maintenance of your new spa. We suggest that you take some time to carefully review all sections. Please keep this manual available for reference.

If you have any questions about any aspect of your spa's set-up, operation or maintenance, contact your authorized **CALDERA** dealership. They are trained professionals who are familiar with the product as well as new spa ownership concerns. Their expertise will facilitate the enjoyment of your new **CALDERA** spa.

The serial number/identification label is located within the equipment compartment of your **CALDERA** spa. The serial number should also be documented on the delivery receipt from your dealer.

IMPORTANT: Watkins Manufacturing Corporation reserves the right to change specifications, or design, without notification and without incurring any obligation.

DATE PURCHASED: _____

DATE INSTALLED: _____

DEALER: _____

ADDRESS: _____

TELEPHONE: _____

SPA MODEL/SERIAL NUMBER: _____

COVER SERIAL NUMBER: _____

MODEL: MARTINIQUE
SERIES: PARADISE
SERIAL: MRA1T1001
RATINGS: 240V, 60Hz, 40A



LISTED SELF CONTAINED SPA
1280 Park Center Dr., Vista, CA 92081
Watkins Manufacturing Corp.

MRA1T1001



MRA1T1001

MRA1T1001

MRA1T1001

MRA1T1001

In most cities and counties, permits will be required for the installation of electrical circuits or the construction of exterior surfaces (decks and gazebos). In addition, some communities have adopted residential barrier codes which may require fencing and/or self-closing gates on the property to prevent unsupervised access to a pool (or spa) by children under 5 years of age. Your **CALDERA** spa is equipped with a locking cover that meets the ASTM F1346-91 Standard for Safety Covers, and as a result, is usually exempt from most barrier requirements. As a general practice, your local Building Department will inform you of any applicable barrier requirements at the time a permit is obtained for the installation of an electrical circuit. Your **CALDERA** dealer can provide information on which permits may be required.

TABLE OF CONTENTS

SAFETY INFORMATION

- Important Safety Instructions 2
- Important Spa Instructions 4

INSTALLATION

- Site Preparation 4
- Outdoor and Patio Installation 4
- Deck Installation 5
- Indoor/Basement Installation 5
- Spa Leveling Preparation 5
- Spa Cover Installation 5

CONTROLS AND EQUIPMENT

- Paradise Makena™ 6
- Paradise Salina® 7
- Paradise Martinique® 8
- Paradise Kauai® 9

ELECTRICAL INSTALLATION

- Electrical Requirements and Precautions 10
- 230 Volt Permanently Connected 10

START-UP AND REFILL PROCEDURES 12

CUSTOMIZING YOUR MASSAGE

- Diverter Valves 13
- Air Controls 13
- Hydro Jets 13
- Air Jets 14

JET MENU

- Paradise **MAKENA** Jet Menu 15
- Paradise **SALINA** Jet Menu 16
- Paradise **MARTINIQUE** Jet Menu 17
- Paradise **KAUAI** Jet Menu 18

OPERATING INSTRUCTIONS

- Control Panel Buttons and Display 19
- System Mode 20
- Clean Cycle 20
- Tools Menu 20
- Audio Control (Option Wireless System Only) 22

EQUIPMENT COMPARTMENT

- Jet Pump Side 24
- Controls Side 25

MAINTENANCE

- Filter Maintenance 26
- Filter Cartridge Removal and Cleaning Instructions 26
- Diverter Valve Maintenance 26
- VersaSage® Jets Maintenance 26
- Draining Your Spa 27
- Winterizing Your Spa 27
- Care of the Spa Pillows 28
- Care of the Exterior 28
- Care of the Spa Cover 29

WATER QUALITY AND MAINTENANCE

- Water Terminology 30
- General Information 30
- Methods for Testing the Spa Water 31
- The Watkins Spa Water Maintenance Program 31
- FROG® Water Care System 33
- Bromine 34
- Supplemental Water Maintenance 35
- Common Water Chemistry Questions 37
- Spa Water Maintenance Troubleshooting Guide 38

SERVICE

- Miscellaneous Service Information 39
- Acts Invalidating Warranty 39
- Disclaimers 39
- Watkins Customer Service 39

SPA TROUBLESHOOTING

- General Operation Troubleshooting Guide 40

WARRANTY

- **PARADISE** Series 41

SPA SPECIFICATIONS Back Cover

SAFETY INFORMATION

IMPORTANT SAFETY INSTRUCTIONS

READ AND FOLLOW ALL INSTRUCTIONS

AVOIDING THE RISK TO CHILDREN

⚠ DANGER:

RISK OF CHILD DROWNING. Extreme caution must be exercised to prevent unauthorized access by children. To avoid accidents, ensure that children cannot use a spa unless they are supervised at all times.

⚠ WARNING:

- To reduce the risk of injury, do not permit children to use this spa unless they are closely supervised at all times.
- To reduce the risk of injury, lower water temperatures are recommended for young children. Children are especially sensitive to hot water.

DO:

- Make sure you always lock the child resistant locks after using the spa for your children's safety. Every **CALDERA** spa is equipped with a locking cover that meets the ASTM F1346-91 Standard for Safety Covers.
- Test the water temperature with your hand before allowing children to enter the spa to be sure that it's comfortable. Children are especially sensitive to hot water.
- Remind children that wet surfaces can be very slippery. Make sure that children are careful when entering, or exiting the spa.

DON'T:

- Allow children to climb onto the spa cover.
- Allow children to have unsupervised access to the spa.

AVOIDING THE RISK OF ELECTROCUTION

RISK OF ELECTROCUTION

- Connect only to a grounded source.
- Do not bury the power cord. A buried power cord may result in death, or serious personal injury due to electrocution if direct burial-type cable is not used, or if improper digging occurs.
- A ground terminal (pressure wire connector) is provided on the control box inside the unit to permit connection of a minimum No. 10 AWG solid copper bonding conductor between this point and any metal equipment, metal water pipe, metal enclosures of electrical equipment, or conduit within five feet (1.5 m) of the unit as needed to comply with local requirements.

⚠ WARNING:

- To reduce the risk of electrical shock, replace a damaged cord immediately. Failure to do so may result in death or serious personal injury due to electrocution.
- Your spa is provided with a Ground Fault Circuit Interrupter for user and equipment protection. To ensure proper operation of this important safety device, test according to the following instructions per electrical configuration.

230 volt, permanently installed models:

- A ground terminal is provided on the terminal block located inside the control box. To reduce the risk of electric shock, connect this terminal to the grounding terminal of your electrical service or supply panel with a continuous green, insulated copper wire. The wire must be equivalent in size to the circuit conductors supplying the equipment. In addition, a bonding terminal (pressure wire connector) is provided on the outside of the control box for bonding to local ground points. To reduce the risk of electric shock, this connector should be bonded with a No. 10 AWG solid copper wire to any metal ladders, water pipes, or other metal within 5 feet (1.5 m) of the spa to comply with local requirements. The means of disconnection must be readily accessible, but must be installed at least 5 feet (1.5 m) from the spa.
- Your spa is provided with a suitably rated circuit breaker to open all ungrounded supply conductors.
- Your spa uses ground fault circuit interrupters in the electrical subpanel. Before each use of the spa and with the unit operating, push the TEST button on each breaker. The switch should click over to the "Trip" position. Wait 30 seconds and reset each GFCI breaker by switching it completely off and then completely on. The switch should then stay on. If either of the interrupters does not perform in this manner, it is an indication of an electrical malfunction and the possibility of an electric shock. Disconnect the power until the fault has been identified and corrected.

⚠ DANGER: RISK OF ELECTRICAL SHOCK

- Install spa at least 5 feet (1.5 m) from all metal surfaces. A spa may be installed within 5 feet of a metal surface if each metal surface is permanently connected by a minimum No. 8 AWG solid copper conductor attached to the wire ground connector on the terminal box that is provided for this purpose if in accordance with National Electrical Code ANSI/NMFA70-1993.
- Do not permit any electrical appliances, such as a light, telephone, radio, or television within 5 feet (1.5 m) of a spa. Failure to maintain a safe distance may result in death, or serious personal injury due to electrocution, if the appliance should fall into the spa.
- Install your spa in such a way that drainage is away from the electrical compartment and from all electrical components.

SAFETY INFORMATION

DO:

- Be sure your spa is connected to the power supply correctly - use a licensed electrical contractor.
- Disconnect the spa from the power supply before draining the spa or servicing the electrical components.
- Test the Ground Fault Circuit Interrupter(s) before each use.

DON'T:

- Use the spa with the equipment compartment door removed.
- Place electrical appliances within 5 feet (1.5m) of the spa.
- Use an extension cord to connect the spa to its power source. The cord may not be properly grounded and the connection is a shock hazard. An extension cord may cause a voltage drop, which will cause overheating of the jet pump motor and motor damage.
- Attempt to open the electrical control box. There are no user serviceable parts inside.

RISKS TO AVOID

DANGER: RISK OF INJURY

- To reduce the risk of injury to persons, DO NOT remove floating weir, basket and filter located in the filter compartment while the spa is running.
- Never replace a suction fitting with one rated less than the flow rate marked on the original suction fitting.
- There is a danger of slipping and falling. Remember that wet surfaces can be very slippery. Take care when entering or exiting the spa.
- Never operate spa if the suction fittings are broken or missing.
- People with infectious diseases should not use the spa.
- Keep any loose articles of clothing or hanging jewelry away from rotating jets or other moving components.

INCREASED SIDE EFFECTS OF MEDICATION

- The use of drugs, alcohol or medication before or during spa use may lead to unconsciousness with the possibility of drowning.
- Persons using medications should consult a physician before using a spa; some medication may cause a user to become drowsy, while other medication may affect heart rate, blood pressure, and circulation.
- Persons taking medications which induce drowsiness, such as tranquilizers, antihistamines, or anticoagulants should not use the spa.

HEALTH PROBLEMS AFFECTED BY SPA USE

- Pregnant women should consult a physician before using spa.
- Persons suffering from obesity, or with a medical history of heart disease, low or high blood pressure, circulatory system problems, or diabetes should consult a physician before using spa.

UNCLEAN WATER

- Keep the water clean and sanitized with correct chemical care. The recommended levels for your **CALDERA** spa are:

| | |
|-------------------|--|
| Bromine: | 1.0 - 2.0 ppm with FROG water care system (3-5 ppm if not using FROG) |
| Water pH: | 7.2 - 7.6 |
| Total Alkalinity: | 40 - 120 ppm |
| Calcium Hardness: | 50 - 150 ppm |

(Refer to Water Quality and Maintenance section for complete instructions.)

IMPORTANT: Turn on the clean cycle when adding any spa water chemicals into the filter compartment.

- Clean the filter cartridge at least monthly to remove debris and mineral buildup which may affect the performance of the hydromassage jets, limit the flow, or trip the high limit thermostat, which will turn off the entire spa.

AVOIDING THE RISK OF HYPERTHERMIA

Prolonged immersion in hot water can result in HYPERTHERMIA, a dangerous condition which occurs when the internal temperature of the body reaches a level above normal (98.6°F). The symptoms of hyperthermia include unawareness of impending hazard, failure to perceive heat, failure to recognize the need to exit the spa, physical inability to exit the spa, fetal damage in pregnant women, and unconsciousness resulting in a danger of drowning.

WARNING:

The use of alcohol, drugs, or medication can greatly increase the risk of fatal hyperthermia in hot tubs and spas.

SAFETY INFORMATION

TO REDUCE THE RISK OF INJURY:

- The water in the spa should never exceed 104°F (40°C). Water temperatures between 100°F (38°C) and 104°F (40°C) are considered safe for a healthy adult. Lower water temperatures are recommended for extended use (exceeding ten minutes) and for young children. Extended use can cause hyperthermia.
- Pregnant or possibly pregnant women should limit spa water temperatures to 100°F (38°C). Failure to do so may result in permanent injury to your baby.
- Do not use spa immediately following strenuous exercise.

AVOIDING THE RISK OF SKIN BURNS:

- To reduce the risk of injury, before entering a spa, the user should measure the water temperature since the tolerance of temperature-regulating devices varies.
- Test the water with your hand before entering the spa to be sure it's comfortable.

WARNING SIGN

Each CALDERA spa is shipped with a WARNING SIGN in the owner's package. The sign, which is required as a condition of Product Listing, should be permanently installed where it is visible to the users of the spa. To obtain additional SAFETY SIGNS, contact your CALDERA dealer and request Part #70798

IMPORTANT SPA INSTRUCTIONS

The following contains important spa information, and we strongly encourage you to read and apply them.

DO:

- Use and lock the cover when the spa is not in use, whether it is empty or full.
- Follow the Spa Care and Maintenance recommendations stated in this manual.
- Use only approved accessories and recommended spa chemicals and cleaners.

DON'T:

- Leave the CALDERA spa exposed to the sun without water or the cover in place. Exposure to direct sunlight can cause solar distress of the shell material.
- Roll or slide the spa on its side. This will damage the siding.
- Lift or drag the vinyl cover by using the cover lock straps; always lift or carry the cover by using the handles.
- Attempt to open the electrical control box. There are no user serviceable parts inside. Opening of the control box by the spa owner will void the warranty. If you have an operational problem, carefully go through the steps outlined in the Troubleshooting section. If you are not able to resolve the problem, contact your authorized CALDERA dealer. Many problems can easily be diagnosed over the telephone by an Authorized Service Technician.

SAVE THESE INSTRUCTIONS

INSTALLATION

SITE PREPARATION

You probably have a spot picked out for your new spa, whether it's indoors or outdoors, on a patio or on a deck. Please make sure you check the following:

- Always put your spa on a structurally sound, level surface. A filled spa can weigh a great deal. Make certain that the location you choose can support the weight of your filled spa.
- Don't forget to level your spa before filling it. (See the Spa Leveling Preparation section on next page.)
- Locate your equipment compartment, which houses all of the electrical components, in a place where water will drain away from it. Allowing water into the equipment compartment can damage the electronics, or may result in tripping your house's circuit breaker.
- Leave yourself easy access to the circuit breakers in the subpanel.
- Never let water get into the subpanel. Your 230 volt spa's subpanel is rain-tight when installed correctly with the door closed. Periodically check these conditions and correct any flaws if detected.
- Leave access to the equipment compartment for periodic spa care and maintenance.

⚠ **WARNING: Damage to the spa's equipment compartment components or internal plumbing as a result of rodent infestation is NOT covered under your warranty!**

OUTDOOR AND PATIO INSTALLATION

No matter where you install your new spa, it's important that you have a solid foundation to support it. Structural damage to the spa, resulting from incorrect installation, or placement on an inadequate foundation, is not covered under the spa's limited warranty.

If you install the spa outdoors, we recommend a reinforced concrete pad at least four inches thick. The reinforcing rod or mesh in the pad should be attached to a bond wire.

INSTALLATION

DECK INSTALLATION

To be certain your deck can support your spa, you must know the deck's maximum load capacity. Consult a qualified building contractor or structural engineer. To find the weight of your spa, its contents and occupants, refer to the Spa Specification chart on back cover. This weight per square foot must not exceed the structure's rated capacity, or serious structural damage could result.

INDOOR/BASEMENT INSTALLATION

Be aware of some special requirements if you place your spa indoors. Water will accumulate around the spa, so flooring materials must provide a good grip when wet. Proper drainage is essential to prevent a build-up of water around the spa. When building a new room for the spa it is recommended that a floor drain be installed. The humidity will naturally increase with the spa indoors. Water may get into woodwork and produce dry rot, mildew, or other problems. Check for airborne moisture's effects on exposed wood, paper, etc. in the room. To minimize these effects, it is best to provide plenty of ventilation to the spa area. An architect can help to determine if more ventilation must be installed.

CALDERA spas are equipped with a jet pump shroud to remove excessive heat from the equipment compartment. Find this vent and be sure the vent is not blocked by anything, including carpeting.

Your **CALDERA** dealer can help you with local information such as zoning regulations and building codes.

⚠ WARNING: Please keep the area around your spa well ventilated when it is installed indoors or in a confined area.

Inadequate ventilation around the spa could cause a build-up of a higher-than-normal concentration of spa chemicals and/or bacterial fragments. These dispersed spa chemicals and/or bacterial fragments can be inhaled, and may result in breathing difficulties or lung damage in certain people suffering from a compromised immune system or respiratory infection. If you or other bathers are affected by this condition, please seek medical attention as soon as possible.

In addition to the above, properly clean and maintain your spa as follows:

- Follow all procedures in this owner's manual and printed instructions on all water care (chemical) products packaging.
- Test the water regularly to ensure proper levels of sanitizers, pH, and other water care requirements.
- Drain, clean, and refill your spa with fresh water on a regular schedule, and in accordance with this owner's manual.
- Clean the filter(s) at least once per month.
- Check to make sure you have proper circulation throughout your spa water system.
- Have spa users bathe before entering the spa water.

SPA LEVELING PREPARATION

Concrete sloped at 1/2 inch (1.3 cm) per 10 feet (305 cm) is preferred so that rain water and water spillover will run off and not puddle underneath the spa (water under the spa for long periods of time may cause the wood to deteriorate). Other options are brick, stepping stone, or blocks.

It is important to note that soft surfaces, even when stepping stones are used to evenly distribute the weight of the spa, will have a tendency to settle, thus resulting in an unlevelled spa.

NOTE: Placing the spa on grass or dirt may increase the amount of debris which is inadvertently brought into the spa water and may cause harm to your equipment as well as the spa surface, which is not covered under warranty.

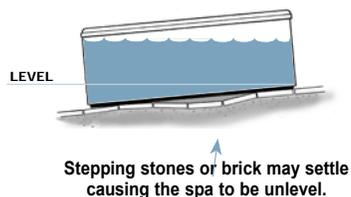
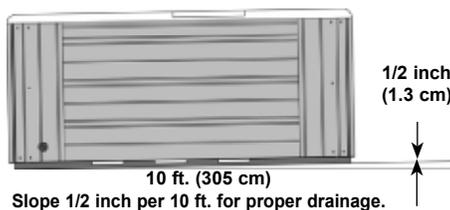

SPA COVER INSTALLATION

- Place the cover squarely on the spa.
- Position the tie-down locks included with your cover on the side of the spa so that they are easily reached by the cover tie-down straps. Allow for about 1/2" to 3/4" slack in the straps to make it easy to insert straps into locks and to compensate for vinyl shrinkage in cold weather.
- Attach the locks with the screws provided and insert the cover tie-down straps into the locks.

NOTE: Keeping the cover in place any time the spa is not in use will reduce the amount of time the heater operates, thereby minimizing operating costs.

Your **CALDERA** spa has been thoroughly tested during the manufacturing process to ensure reliability and long-term customer satisfaction. A small amount of water may have remained in the plumbing after testing and, as a result, may have spotted the spa shell or the spa siding prior to delivery. Before filling the spa, wipe the spa shell clean with a soft rag. The following instructions must be read and followed exactly to ensure a successful start-up or refill.

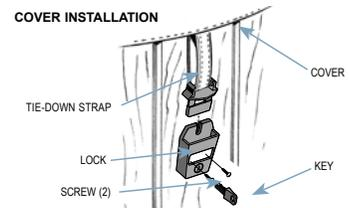

DANGER. RISK OF INJURY.

- **Never leave a spa uncovered or unattended.**
- **Never leave a spa cover unlocked.**
- **Do not stand, sit, or lie on the cover.**

CONTROLS AND EQUIPMENT

PARADISE MAKENA



OVERHEAD VIEW

- | | | | |
|--------------------------|------------------------------|---------------------------|------------------------|
| 1. Air Control Valve | 6. Euphoria® Jet | 11. Pillow | 16. FROG® Housing |
| 2. Temperature Sensor | 7. Diverter Valve | 12. Filter Compartment | 17. Speaker (Optional) |
| 3. Euro Directional Jet | 8. Drain | 13. Acquarella® Waterfall | |
| 4. VERSASSAGE Jet | 9. Ozone Jet / Heater return | 14. Waterfall Valve | |
| 5. AdaptaFlo® Jet | 10. Control Panel | 15. Assist Bar | |

CONTROLS AND EQUIPMENT

PARADISE SALINA



OVERHEAD VIEW

- | | | | |
|--------------------------|------------------------------|---------------------------------|-------------------------|
| 1. Air Control Valve | 6. EUPHORIA Jet | 11. Pillow | 16. FROG Housing |
| 2. Temperature Sensor | 7. Diverter Valve | 12. Filter Compartment | 17. Speaker (Optional) |
| 3. Euro Directional Jet | 8. Drain | 13. ACQUARELLA Waterfall | |
| 4. VERSASSAGE Jet | 9. Ozone Jet / Heater return | 14. Waterfall Valve | |
| 5. ADAPTAFLO Jet | 10. Control Panel | 15. Assist Bar | |

CONTROLS AND EQUIPMENT

PARADISE MARTINIQUE



OVERHEAD VIEW

- | | | | | |
|-------------------------|--------------------------|---------------------------------|------------------------------------|-------------------------|
| 1. Air Control Valve | 5. ADAPTA FLO Jet | 9. Speaker (Optional) | 13. Filter Compartment | 17. FROG Housing |
| 2. Euro Directional Jet | 6. VERSASSAGE Jet | 10. Ozone Jet/ Heater return | 14. Assist Bar | |
| 3. Temperature Sensor | 7. Diverter Valve | 11. Control Panel | 15. ACQUARELLA Waterfall | |
| 4. AdaptaSsage® Jet | 8. Drain | 12. Pillow | 16. Waterfall Valve | |

CONTROLS AND EQUIPMENT

PARADISE KAUAI

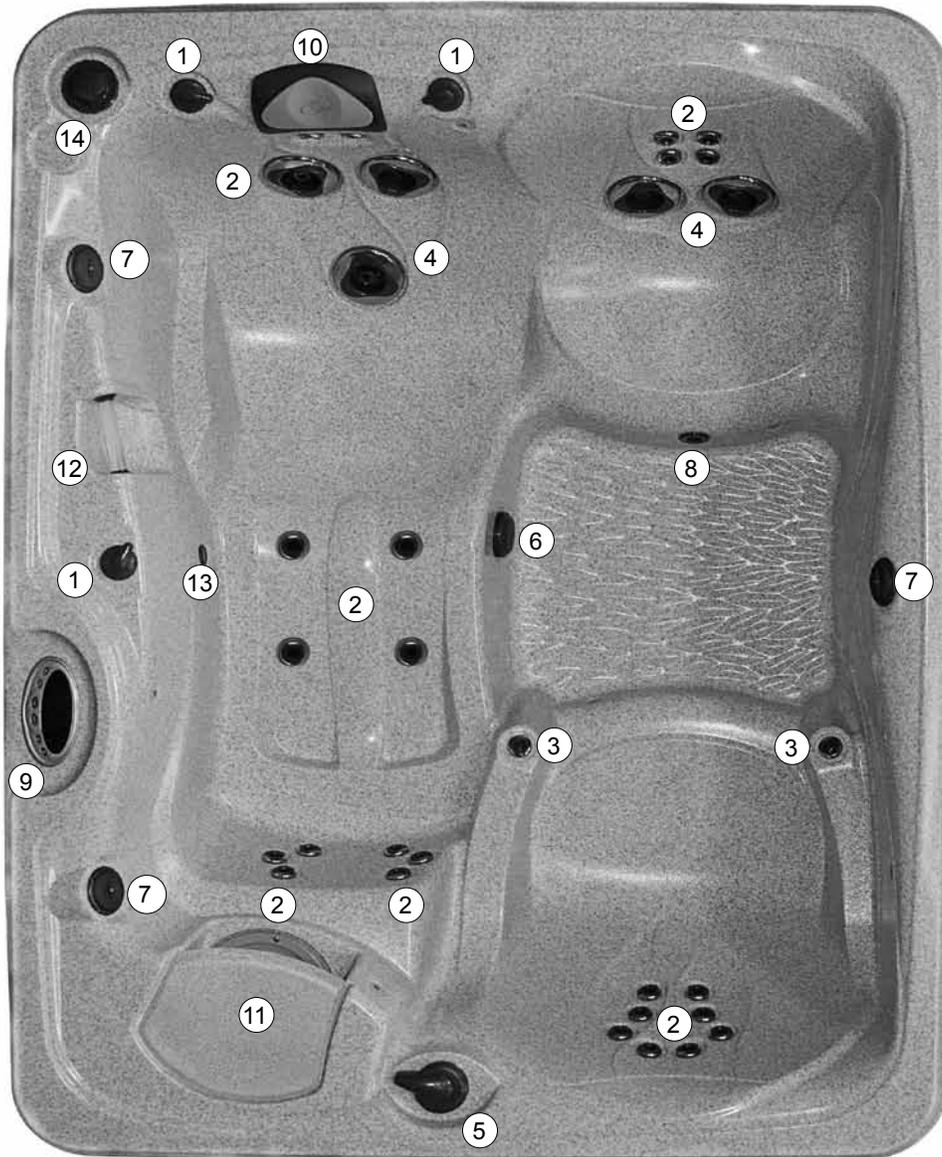

OVERHEAD VIEW

- | | | | | |
|-------------------------|--------------------------|------------------------------|-------------------------|------------------------|
| 1. Air Control | 4. VERSASSAGE Jet | 7. Speaker (Optional) | 9. Control Panel | 12. Assist Bar |
| 2. Euro Directional Jet | 5. Diverter Valve | 8. Ozone Jet / Heater Return | 10. Pillow | 13. Temperature Sensor |
| 3. Euro-Pulse® Jet | 6. Drain | 11. Filter Compartment | 14. FROG Housing | |

ELECTRICAL INSTALLATION

ELECTRICAL REQUIREMENTS AND PRECAUTIONS

Your CALDERA Spa has been carefully designed to give you maximum safety against electrical shock. Connecting the spa to an improperly wired circuit will negate many of the spa's safety features. Improper wiring may also cause electrocution, risk of fire, and other risks of injuries. Please read and follow the electrical installation requirements and instructions for your spa completely!

230 VOLT PERMANENTLY CONNECTED

CALDERA SPAS MUST BE WIRED IN ACCORDANCE WITH ALL APPLICABLE LOCAL ELECTRICAL CODES. ALL ELECTRICAL WORK SHOULD BE DONE BY AN EXPERIENCED LICENSED ELECTRICIAN. WE RECOMMEND THE USE OF APPROPRIATE ELECTRICAL CONDUIT, FITTINGS, AND WIRE FOR ALL CIRCUITS.

An electrical subpanel containing two GFCI breakers is included with each spa. We recommend that this subpanel be used to supply power and protect the spa.

This subpanel requires a 50 amp, single phase, 230 volt, four wire service (two line, one neutral, one ground). The ground wire must never be less than #10 AWG. Use NEC 250-122 (table) and local codes for more information. A minimum #10 AWG solid copper bond wire is also required.

Mount the subpanel in the vicinity of the spa, but not within five feet, in accordance with local codes.

INSTALLATION INSTRUCTIONS

To connect the electrical service, first remove the screws from the equipment compartment door, lower the door one inch and remove the door.

1. Locate the spa control box. Remove the screws on the front of the control box and remove the control box cover.

2. Route the electrical service from the subpanel into the spa equipment compartment.

NOTE: The subpanel must be placed in sight of the spa, no closer than five feet.

3. Connect wire to bottom of control box using a minimum of ¾" liquid-tight, flex conduit fitting.

WIRING CONNECTIONS

1. Identify the TB-1 terminal block, located inside the control box at the lower left-hand corner.

2. Connect the #12 AWG, BLUE wire, from the subpanel 20 amp breaker, terminal L1 to TB-1, terminal 2.

3. Connect the #12 AWG, RED wire, from the subpanel 20 amp breaker, terminal L2 to TB-1, terminal 4.

NOTE: The WHITE neutral wire must be attached to the LOAD neutral on the 230 volt, 30 amp breaker (not to the neutral bus bar in the subpanel). The WHITE neutral wire coming from the breaker itself is already connected to the neutral bus bar.

4. Connect the #10 AWG, BLUE wire, from the subpanel 30 amp breaker, terminal L1 to TB-1, terminal 5

5. Connect the #10 AWG, RED wire, from the subpanel 30 amp breaker, terminal L2 to TB-1, terminal 6

6. Connect the #10 AWG, WHITE wire, from the subpanel 30 amp breaker, terminal N (load neutral) to TB-1, terminal 7

7. Connect the #10 AWG, GREEN wire, from the subpanel GROUND bar to TB-1, system ground terminal.

8. Using the pressure wire connector provided on the outside of the control box, bond the spa to all exposed metal equipment or fixtures, handrails, and the concrete pad (if applicable) per N.E.C. and local codes.

9. Replace the control box cover and securely tighten the fastening screws. Close and secure the equipment compartment door as follows:

- Place top of door or panel directly below bartop against the frame of the spa.
- Push bottom of door or panel against the spa frame.
- Slide door or panel upward (pushing in on center of door) until screw holes line up.
- Slightly pull on door or panel, if door remains against the spa then replace the screws.
- If the door does not lock into position, repeat the previous steps.

⚠ WARNING: FILL THE SPA WITH WATER BEFORE TURNING ON THE POWER! (See STARTUP AND REFILL PROCEDURES.)

Once your spa has been filled with water, turn it on and test all of the circuit breakers.

NOTE: If both breakers immediately trip, verify that the #10 AWG WHITE neutral wire is connected from TB-1 terminal 7 to the N (load neutral) terminal of the 30 amp subpanel breaker. Each breaker should be tested prior to each use. Here's how:

1. Push the "TEST" button on each GFCI breaker, and observe it click OFF.

2. Wait 30 seconds, then push the breaker switch to the OFF (down) position (to ensure that it has completely disengaged), then push the breaker switch to the ON (up) position. If you don't wait 30 seconds, the spa's control panel may flash four lines on and off – try again.

If any of the GFCI breakers fails to operate in this manner, your spa may have an electrical malfunction, and you may be at risk of electrical shock. Turn off all circuits and do not use the spa until the problem has been corrected by an authorized service agent.

SERVICE NOTE: All CALDERA spas have diagnostic functions that are displayed on the main control panel when the Power Indicator, Ready Indicator or both are blinking. Follow the instructions in the troubleshooting section to identify and correct the cause.

⚠ WARNING: Removing or bypassing any GFCI breaker will result in an unsafe spa and will void the spa's warranty.

IMPORTANT: If you ever need to move or relocate your CALDERA spa, it is essential that you understand and apply these installation requirements. Your CALDERA spa has been carefully engineered to provide maximum safety against electric shock. Remember, connecting the spa to an improperly wired circuit will negate many of its safety features.

NOTE: Long wiring runs may require larger-gauge wire than stated.

ELECTRICAL INSTALLATION

PARADISE SERIES WIRING DIAGRAM

230 Volt Permanently Connected

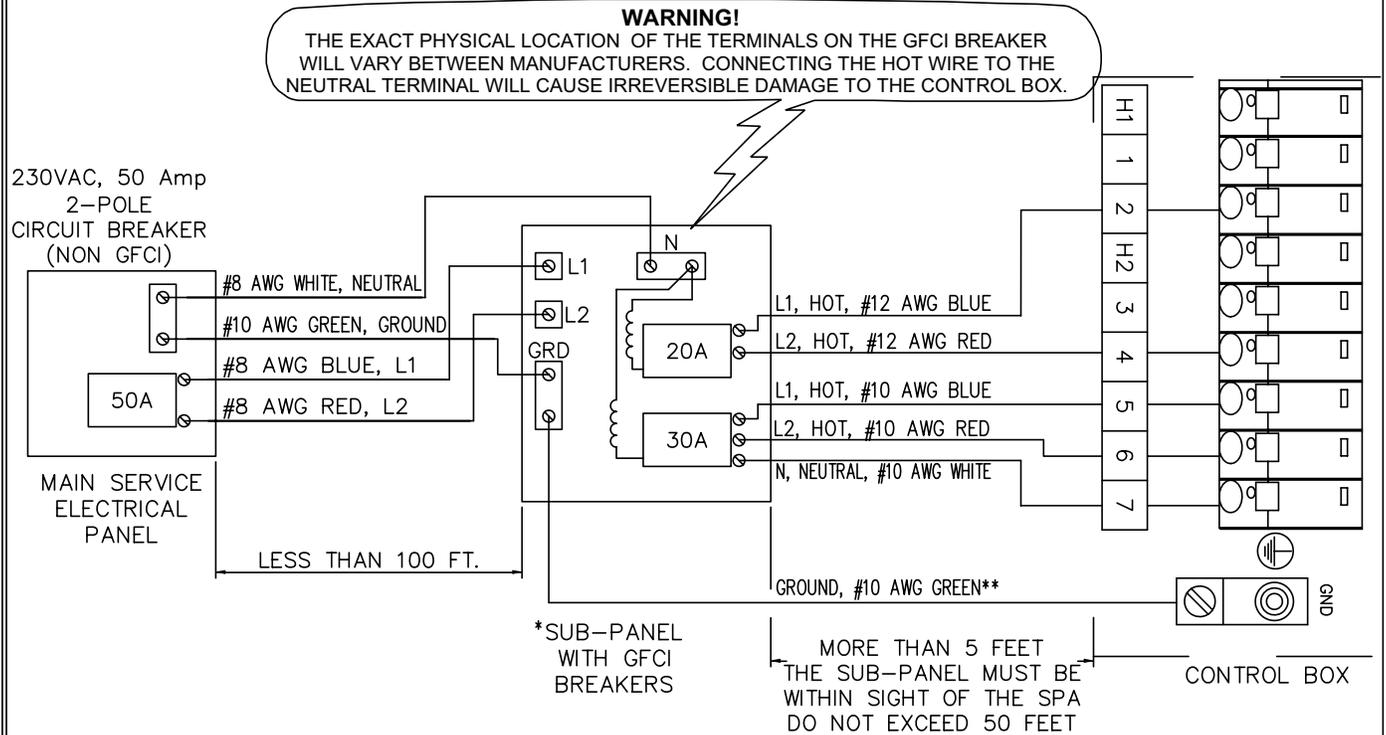

** Refer to NEC 250-122 (table)

NOTE: The wire connections to GFCI breakers are for reference only. Always ensure the white neutral wire is connected to the load neutral of the 30 amp breaker.

***PROVIDED WITH SPA.**

NOTE: ALL WIRING SHOULD BE COPPER.

POWER CONNECTION ACCESS

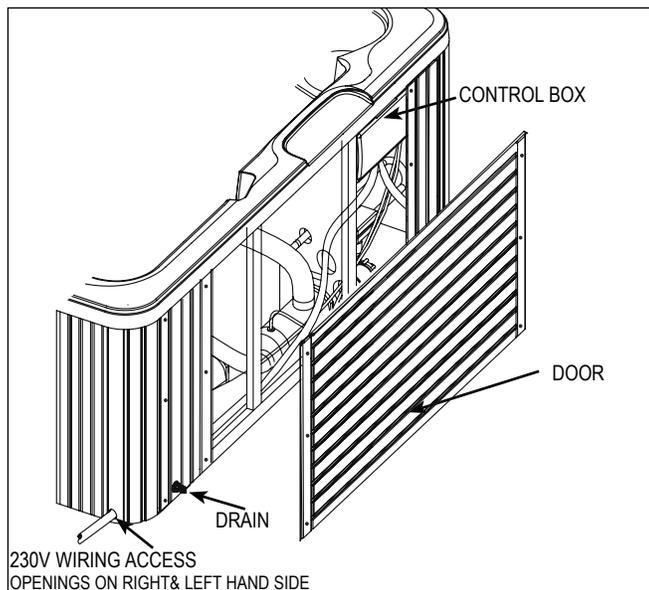

START-UP AND REFILL PROCEDURES

Your CALDERA spa has been thoroughly tested during the manufacturing process to ensure reliability and long-term customer satisfaction. A small amount of water may have remained in the plumbing after testing and, as a result, may have spotted the spa shell or the spa siding prior to delivery. Before filling the spa, wipe the spa shell clean with a soft rag. The following instructions must be read and followed exactly to ensure a successful start-up or refill.

CAUTIONS

- Do NOT fill the spa with hot water, as tripping of the high-limit thermostat may result.
 - DO NOT CONNECT POWER TO AN EMPTY SPA. Power to the spa automatically activates critical components within the spa, such as controls, heater, and other systems. If power is supplied to these components prior to the spa being filled, the components will be damaged, and this may result in a non-warranty component failure.
 - DO NOT use your spa after filling until all of the steps listed below are completed.
 - DO NOT add chlorine if treating your spa with polyhexamethylene biguanide (Biguanide, PHMB, eg. BaquaSpa®) sanitizer.
 - Before filling your spa for the first time, remove the equipment compartment door and check to ensure that the unions on either side of the pump(s) and heater are hand-tight.
1. **CLOSE ALL DRAINS, remove the filter compartment cover, skimmer basket, weir, and filter.** Fill your spa through the filter compartment using the CleanScreen™ pre-filter that attaches to your garden hose. The water level of your spa should be maintained at a level one inch above the highest jet in the spa. Reinstall the filter and then the skimmer basket, and weir once the spa is filled.

IMPORTANT: *Watkins Manufacturing Corporation does not recommend that the spa be filled with "softened" water, as this may damage the spa's equipment.*

2. **AFTER THE SPA HAS BEEN FILLED** with water and the equipment compartment door is secured, power must be applied to the spa.
 - FIRST activate power to the subpanel from the main house panel.
 - NEXT open the door of the electrical subpanel and reset the GFCI breaker.
 - FINALLY, close and secure the subpanel door.
3. **TO CHECK THE OPERATION OF THE JET SYSTEM** and to purge any remaining air from the heating system, push the "JETS" button on the control panel **three times** (once for **KAUAI** model) to run the jet pump(s) on high speed for one minute. Once the jet system is fully operational (as indicated by strong, non-surgling jets), priming of the spa is complete. Turn off the jets by pressing the "JETS" button until all jets have turned off. If you do not feel a steady stream of water from your jets, refer to the instructions for priming the pump in the SPA TROUBLESHOOTING section in the back of this manual.
4. **USING A TEST STRIP AND APPLICABLE CHEMICALS** adjust Total Alkalinity (TA) to 40-120 ppm, Calcium Hardness (CH) to 50-150 ppm, then spa water pH to between 7.2 and 7.8. These procedures are listed in the "Water Quality and Maintenance" section.
5. **SUPERCHLORINATE THE SPA WATER** by adding 1½ teaspoons of **MONARCH** chlorine (sodium dichlor) per 250 gallons (950 liters) of spa water, then activate the Clean cycle by pressing "MODE ▲" or "MODE ▼" until CLEAN is displayed then press the "ON ▲" button .
6. **SET THE TEMPERATURE CONTROL** to the desired temperature between 100°F (38°C) and 104°F (40°C), then place the spa cover on the spa and allow the water temperature to stabilize (approximately 24 hours). Make sure you secure the cover in place using the cover locks. Periodically check the spa water temperature. When the water temperature climbs above 90°F (32°C), proceed to the next step. The spa temperature is pre-programmed to reach 100F (39°C), and will normally do so within 18 to 24 hours. You may raise the water temperature by pressing the Temp (▲) button on the control panel, or lower it by pressing Temp (▼) button. After a few hours, the water temperature will remain within 3°F (1.5°C) of your selected temperature.
7. **TEST THE SPA WATER FOR BROMINE RESIDUAL.** If the residual is between 1 and 2 ppm on the test strips, go on to the next step. If the residual is less than 1 ppm, activate the Clean cycle, and then retest.

IMPORTANT: *For Canada, if you are only using the bromine cartridge, your bromine levels should be between 3.0 - 5.0 ppm.*

8. **INSTALL FROG bromine and mineral cartridges.** Dial the mineral cartridge to setting 6 and snap into the top space of the cartridge holder. Dial the bromine cartridge to the appropriate setting based on the chart below and snap into the bottom space of the cartridge holder.

| Spa Size (gallons) | 250-300 | 300-400 | 400-500 |
|--------------------|---------|---------|---------|
| Bromine Setting | 2 | 2 | 3 |

WARNING: *High sanitizer levels can cause discomfort to the user's eyes, lungs and skin. Always allow the sanitizer level to fall to the recommended range before using the spa.*

IMPORTANT: *Each time the spa is filled with water, you must remove and reinstall the FROG cap, even if you are not replacing the cartridge, in order to properly prime the jet pumps.*

9. **RECHECK** the Total Alkalinity (TA) 40-120 ppm, Calcium Hardness (CH) 50-150 ppm, then spa water pH at between 7.2 and 7.8.
- OPERATION NOTE:** *Make sure you adjust your Total Alkalinity first, as an out-of-balance condition will affect your ability to adjust the pH correctly, and will affect the sanitizers effectiveness.*

The spa is ready for use when the spa water has circulated and the bromine level remains between 1-ppm and 2-ppm.

OPERATION NOTE: For proper water circulation during the ten-minute Clean cycle the following steps should be performed.

- Place the diverter valve in the middle (split flow) position
- Place air control levers in OFF position by rotating clockwise

CUSTOMIZING YOUR MASSAGE

Your **CALDERA** spa offers numerous ways for you to customize your massage experience. Experimentation is the best way to find what feels best to you. Try sitting in different seats, adjusting the diverter valves, air controls, and jet nozzles and turning each pump on or off.

DIVERTER VALVES

The diverter valves on your spa allow you to direct the flow of water from the pumps to various combinations of jets. The functions of these diverter valves can best be learned by experimentation as follows:

1. Set all air controls to the "ON" position by rotating counterclockwise.
2. Turn on both pumps.
3. Turn the handle on each diverter valve and see which groups of jets are affected.
(Note: You can adjust the diverter valves to any position between the two possible extremes to achieve the jet pressure that feels best to you.)

IMPORTANT: Your spa is not designed to provide full power to all jets when the diverter valves are in the "mid" position. However, with the diverter valve in this position, you may increase the power to selected jets by rotating the face of the **VERSASSAGE**, **ADAPTASSAGE** and **ADAPTAFLO** jets to close the ones that are not in use.

TIP: Turn both pumps on and place the diverter valves to the "Mid-Position", then experiment with each of the air controls to see their effect.

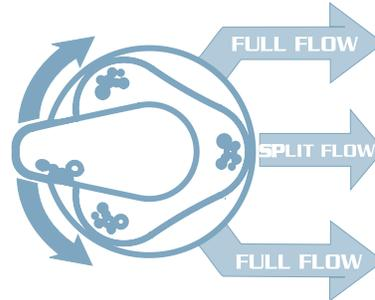

Position 1 - The full flow is directed to one series of jets.

Mid-Position - Positioning the diverter at any point between position one and two divides the flow between the jet systems.

Position 2 - The full flow is directed to a second series of jets.

WATERFALL VALVE

The **SALINA**, **MAKENA** and **MARTINIQUE** spas are equipped with a cascading waterfall feature. It is activated by pressing the "JETS" button and turning the valve located on the front interior wall counterclockwise. The flow is regulated by turning the waterfall valve to the desired position.

AIR CONTROLS

Each jet system has its own air control. These allow you to change the power of the jets by regulating the amount of air that is mixed with the water coming out of the jets.

HYDRO JETS

ADAPTAFLO Jets - These jets allow you to redirect the jet stream by changing the position of the nozzle.

ADAPTASSAGE Jets - These jets provide a rotating massage pattern.

The face plates in the **ADAPTAFLO** jets and the **ADAPTASSAGE** jets are interchangeable. To remove a **ADAPTASSAGE** face plate, turn it counter-clockwise until it stops turning. Turn the face once more until you hear a clicking noise, push it in, and then pull it straight off. Install the face plate by snapping it into place. Additional **ADAPTASSAGE** dual-port nozzles are available from your **CALDERA** dealer.

Both the **ADAPTAFLO** and **ADAPTASSAGE** jets allow you to regulate the force of the massage. Rotate the fascia ring to reduce or increase the force. Notice that turning off the flow to some jets increases the flow to the other jets. To avoid damage to your spa's plumbing and components, do not turn off more than half of these jets at the same time.

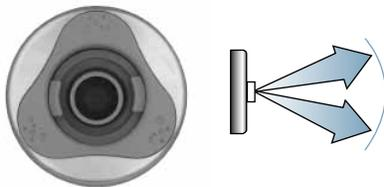
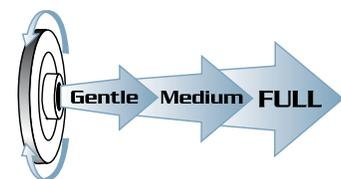
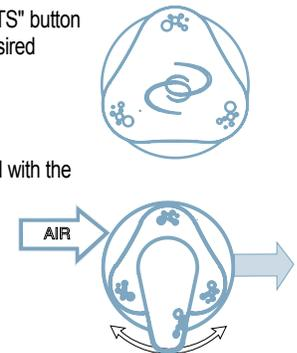

ADAPTAFLO Jet

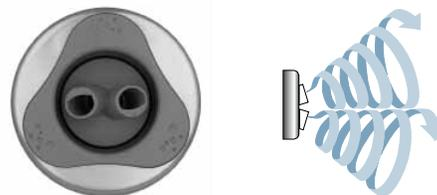

ADAPTASSAGE Jet

CUSTOMIZING YOUR MASSAGE

Euro Directional and EURO-PULSE Jets - The Euro Directional jets, with eyeball nozzles, deliver a direct, more focused massage. The **EURO-PULSE** jets feature a special insert that creates a soft, pulsating, rotary massage. The **EURO-PULSE** jet cap assemblies may be removed if you want a more powerful, direct massage in the wrist locations. To do this, rotate the jet face counter clockwise and pull off. Then simply press and twist Euro Directional Jet into place. If you desire, you may install a **EURO-PULSE** jet in place of any of the Euro Directional jet by simply following the same procedure as mentioned. You may purchase additional rotary jet assemblies from your **CALDERA** dealer.

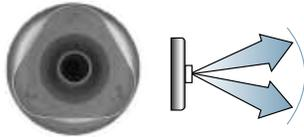

Euro Directional Jet



EURO-PULSE Jet

VERSASSAGE Jets - These jets may be adjusted to provide either a stationary, direct stream or, by positioning the nozzle to one side or the other, a rotating jet stream. The **VERSASSAGE** jets allow you to regulate the force of the massage. Rotate the fascia ring counter-clockwise to reduce the force, or clockwise to increase the force. Notice that turning off the flow to some jets increases the flow to the other jets. To avoid damage to your spa's plumbing and components, do not turn off more than half of these jets at the same time. For cleaning instructions, see the **VERSASSAGE** Jets Maintenance section.

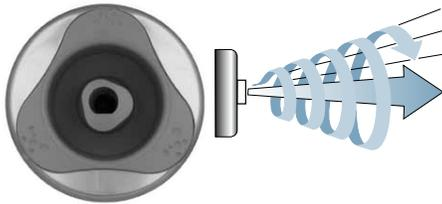

VERSASSAGE Jet

EUPHORIA Jet - The **EUPHORIA** jet provides a deep powerful, penetrating massage to your tired feet, calves, knees and thighs.

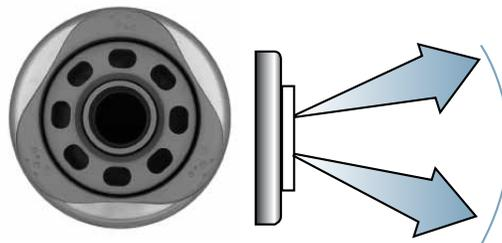

EUPHORIA Jet

JET MENU

MAKENA



SYSTEM 1 MENU A

(Diverter in  position)

- Waterfall
- 1 **EUPHORIA** jet in footwell
- 2 Euro Directional jets in footwell
- 2 **ADAPTAFLO** jets – back wall
- Located in LumbarSsage® Seat – back right
- 5 Euro Directional jets
- 2 **VERSASSAGE** jets



SYSTEM 1 MENU B

(Diverter in  position)

- Waterfall
- Located in UltraMassage® lounge – front
- 6 Sole Soothers®
- 3 **VERSASSAGE** jets
- 4 Euro Directional jets



SYSTEM 2

- 1 **VERSASSAGE** jets – on right wall
- 2 Euro Directional jets - on right wall
- 2 Euro Directional jets in footwell
- Located in Ecsta Seat® – back left:
- 14 Euro Directional jets

COMBINATION JET SYSTEM

Diverter in mid position activates both menus in system 1

JET MENU

SALINA



SYSTEM 1

- 2 ADAPTAFLO jet - on back wall
 - Waterfall on right wall
- Located in **ECSTA SEAT** – back left:
- 14 Euro Directional jets



SYSTEM 2 MENU A

(Diverter in **A** position)

- 1 EUPHORIA jet in footwell
- 1 VERSASSAGE jets – on right wall
- 2 Euro Directional jets - on right wall
- 2 VERSASSAGE jets – on front left wall
- 4 Euro Directional jets - on front left



JET SYSTEM 2 MENU B

(Diverter in **B** position)

- 4 Euro Directional jets in footwell
- Located in **LUMBARSSAGE** Seat – back right
- 5 Euro Directional jets
 - 2 VERSASSAGE jets
- Located in front right seat
- 2 ADAPTAFLO jets
 - 1 VERSASSAGE jet

COMBINATION JET SYSTEM

Diverter in mid position activates both menus in system 2

JET MENU

MARTINIQUE



SYSTEM 1 MENU A

(Diverter in  position)

Located in **ULTRAMASSAGE** lounge – front

- 6 **SOLE SOOTHERS**
- 3 **VERSASSAGE** jets
- 6 Euro Directional jets
- Waterfall



SYSTEM 1 MENU B

(Diverter in  position)

- 2 **ADAPTASSAGE** jets on left wall
- 2 **VERSASSAGE** jets in foot well

Located in **ULTRAMASSAGE** lounge – front:

- 2 Euro Directional jets
- 3 **VERSASSAGE** jets
- Waterfall



SYSTEM 2

Located in **ECSTA SEAT** – back left :

- 8 Euro Directional jets

Located in **LUMBARSSAGE** Seat – back right

- 4 Euro Directional jets
- 2 **VERSASSAGE** jets

Located in Center seat

- 1 **ADAPTAFLO** jet

COMBINATION JET SYSTEM

Diverter in mid position activates both menus in system 1

JET MENU

KAUAI

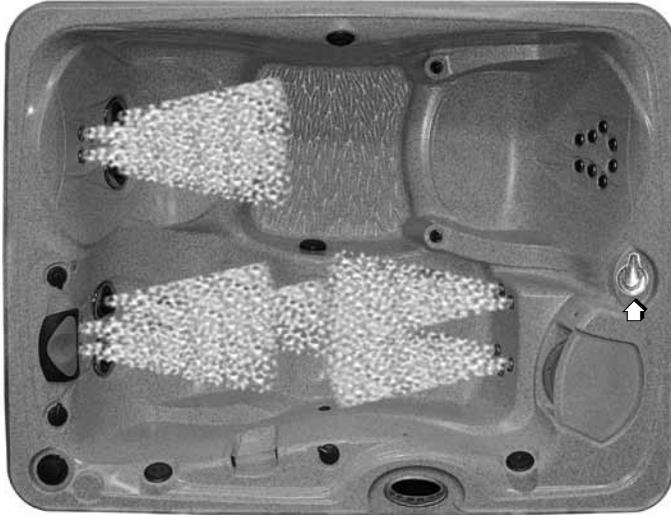

SYSTEM 1 MENU A

(Diverter in  position)

Located in **ULTRAMASSAGE** lounge

- 6 **SOLE SOOTHERS**
- 3 **VERSASSAGE** jets
- 6 Euro Directional jets

Located in **LUMBARSSAGE** seat

- 4 Euro Directional jets
- 2 **VERSASSAGE** jets

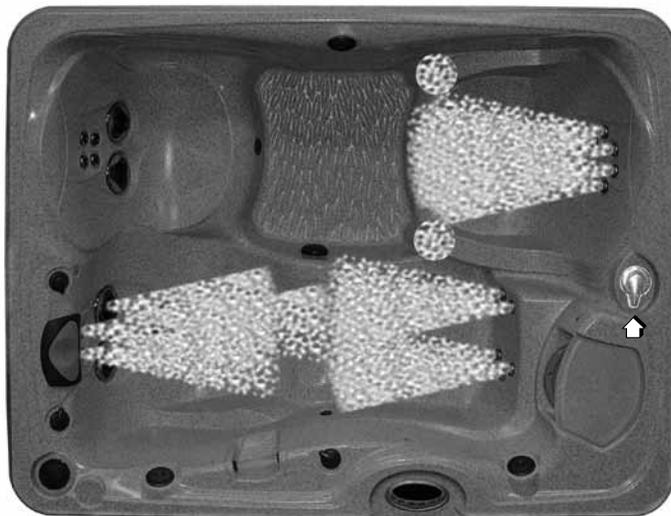

SYSTEM 1 MENU B

(Diverter in  position)

Located in **ULTRAMASSAGE** lounge

- 6 **SOLE SOOTHERS**
- 3 **VERSASSAGE** jet
- 6 Euro Directional jets

Located in **ECSTA SEAT**

- 8 Euro Directional jets
- 2 **EURO-PULSE** jets

COMBINATION JET SYSTEM

Diverter in mid position activates both menus in system 1

OPERATING INSTRUCTIONS

CONTROL PANEL

Your spa comes equipped with a control panel located on the bartop above the equipment compartment door. The control panel allows the user to set the temperature, activate the jets and lights, and access menus to lock the temperature and/or spa functions, and uses indicator lights and an integrated LCD display to provide a quick visual check of the spa's status.



CONTROL PANEL BUTTONS AND DISPLAY

Your spa control system consists of an illuminated Light Emitting Diode (LED) display and convenient push buttons that allow you to set the water temperature, as well as the hydrotherapy jets, mood lighting, and optional jets from the spa control panel.

DISPLAY INVERSION

You may invert the control panel display for easier viewing from inside the hot tub.

To invert the display the following is required:

Press the "MODE ▼" & "OFF ▼" buttons simultaneously. By pressing the "MODE ▼" & "OFF ▼" buttons simultaneously a second time the screen will go back to its original display.

TEMPERATURE CONTROL



The set temperature range is from 80°F (26°C) to 104°F (40°C). The set temperature of the spa water will automatically be 100°F (38°C) the first time power is applied. This is the setting programmed at the factory. After the spa has been set up and used, the last temperature value set by the user will be stored in memory. If power is disconnected from the spa, it will automatically revert to the last set temperature when power is reapplied.

To display the set temperature of the spa, press the "ON ▲" button. The set temperature will be displayed, unless the spa is locked (in which case the lock icon is displayed). The set temperature display will automatically return to actual temperature after five seconds. To increase the set temperature of the spa water, press the "ON ▲" button. Each time the button is pressed, the set temperature display will increment by one degree. If the button is held down, the set temperature display will increase by one degree every half-second.

To decrease the set temperature of the spa water, press the "OFF ▼" button. Each time the button is pressed, the set temperature display will decrement by one degree. If the button is held down, the set temperature display will decrease by one degree every half-second.

If the set temperature value will not change, check the TEMP LOCK and SPA LOCK features. When either of these features is applied, the temperature control is disabled.

OPERATING INSTRUCTIONS

JETS BUTTON



The "JETS" button is used to activate the jet pump(s). Pressing "JETS" button once will illuminate the jets symbol on the control panel display. The symbol will remain lit until the jet pump(s) are turned off, or after one hour of continuous operation when the pump(s) are automatically shut off by the control system.

MAKENA, SALINA & MARTINIQUE MODELS :

- 1st press = jet pump on low speed in system 1
- 2nd press = jet pump on high speed in system 1
- 3rd press = jet pumps on high speed in systems 1 & 2
- 4th press = jet pump on low speed in system 1 & jet pump on high speed in system 2
- 5th press = jet pump on high speed in system 2
- 6th press = jet pumps off

KAUAI MODEL:

- 1st press = pump on high speed
- 2nd press = pump off

LIGHTS BUTTON



The "LIGHTS" button activates the LED lighting system and controls its intensity. Pressing the "LIGHTS" button operates the light as follows:

- 1st press of the "LIGHTS" button: light intensity on high
- 2nd press: light intensity on medium
- 3rd press: light intensity on low
- 4th press: lights off

If the lights are left on, they will automatically be turned off by the control system after six hours of continuous operation. The light symbol on the control panel will also turn off.

If the lights will not turn on, make sure SPA LOCK is deactivated. SPA LOCK disables the controls on both the main and auxiliary control panel. (See the SPA LOCK section for more information on the SPA LOCK feature.)

SYSTEM MODE



Your spa is equipped with a System Mode. This function will allow you to conveniently turn the jet(s) on high speed and the light on maximum intensity. If your spa is equipped with a music system it will not turn the music on, however when the system mode is deactivated the music system will turn off.

To activate the system mode, perform the following functions:

Press the "MODE ▲" button until **SYSON** is displayed on the screen. Press the "ON ▲" button to activate the **SYSON** mode feature.

NOTE: Once activated, any of the functions may be changed without effecting anything else.

To deactivate the system mode, press the "MODE ▲" button until **SYSON** is displayed on the screen. Press the "OFF ▼" button to deactivate.

CLEAN CYCLE



The Clean Cycle has been provided as a convenient timer for water maintenance. When the mode is activated, jet pump 1 will turn on and run for ten minutes (used for water maintenance). To activate the Clean Cycle, press the "MODE ▲" or "MODE ▼" button until the word **CLEAN** is displayed on the screen. Press the "ON ▲" button to activate the **CLEAN** cycle feature.

NOTE: The jet icon will flash on and off in the main display while the Clean Cycle is active.

To stop the Clean Cycle before the ten minutes is complete, Press the "MODE ▲" or "MODE ▼" button until the word **CLEAN** is displayed on the screen. Press the "OFF ▼" button to deactivate.

NOTE: Pressing the JETS button will also deactivate the clean cycle.

TOOLS MENU



The **TOOLS** menu is one of the main menus on the control panel. Within the **TOOLS** menu are six submenus, which consists of; Temp Lock, Spa Lock, Light, Summer Timer and Exit.

To enter into the **TOOLS** menu, scroll through the main menu using the "MODE ▲" or "MODE ▼" button until the **TOOLS** menu is displayed. Press the "ON ▲" button to enter into the **TOOLS** submenu, use the "MODE ▲" or "MODE ▼" button to scroll through the submenus. Once the desired submenu is displayed, press the "ON ▲" button to activate the submenu or press the "OFF ▼" button to deactivate the submenu. To leave the **TOOLS** submenu, scroll through the submenu until **EXIT** is displayed, press the "ON ▲" button to exit the submenu.

LOCKING FEATURES

The two locking features, SPA LOCK and TEMPERATURE LOCK, are enabled from the control panel by pressing the "MODE ▲" or "MODE ▼" button until the **TOOLS** menu is displayed. Then press the "ON ▲" button to enter the **TOOLS** submenus. Use the "MODE ▲" or "MODE ▼" button to scroll through the submenus to get to the locking features. Once enabled, a lock will remain active until the specific button combination is applied to disable the lock. Even if power is disconnected from the hot tub and soon thereafter reapplied (such as in a power outage) the lock will remain in place.

OPERATING INSTRUCTIONS

TEMPERATURE LOCK

The TEMPERATURE LOCK feature deactivates the temperature control function of the control panel. The JETS and the LIGHTS functions will operate normally. TEMPERATURE LOCK is most often used by people who do not want others to tamper with or change the set temperature of the hot tub water. TEMPERATURE LOCK is a submenu of the **TOOLS** menu.

To activate the TEMPERATURE LOCK, press the "MODE ▲" button in the **TOOLS** submenu until the **TMPLK** symbol is displayed on the screen. The lock icon will flash on and off when deactivated. Press the "ON ▲" button to activate the TEMPERATURE LOCK feature. The lock icon will be displayed when activated.

When the TEMPERATURE LOCK is activated, the JETS, LIGHTS and any other features your hot tub may have will operate normally, and the temperature setting can be viewed but can NOT be changed.

To deactivate the TEMPERATURE LOCK, press the "MODE ▲" button in the **TOOLS** submenu until the **TMPLK** symbol is displayed on the screen. Press the "OFF ▼" button to deactivate the TEMPERATURE LOCK feature.



SPA LOCK

The SPA LOCK feature deactivates all of the functions of the control panel. It is generally used to prevent unwanted use of the spa. The SPA LOCK menu is a submenu of the **TOOLS** menu. To activate the SPA LOCK, press the "MODE ▲" button in the **TOOLS** submenu until **SPALK** is displayed on the screen. Press the "ON ▲" button to activate the SPA LOCK feature. The lock icon will be displayed when activated.

When the SPA LOCK is activated, the buttons for the JETS, LIGHTS, temperature control, and any other features your spa may have are deactivated. To deactivate the SPA LOCK, press the "MODE ▲" button in the **TOOLS** submenu until **SPALK** and lock icon is displayed on the screen. Press the "OFF ▼" button to deactivate the SPA LOCK feature.



LOCK OVERRIDE

The Lock Override feature is for spa users who normally keep the set temperature locked. Should the user wish to lock all spa controls temporarily, the spa lock can be applied over an already-applied temperature lock. Then, when the spa lock is removed, the temperature lock will remain on to prevent unwanted tampering with the set temperature.

LIGHT MENU

Your spa lights can display in a variety of different colors, different intensities as well as run through a continuous sequence of colors. The Light menu is a submenu of the **TOOLS** menu. To activate this function the following is required:

1. On the control panel press the "MODE ▲" or "MODE ▼" button in the **TOOLS** submenu to scroll to the **LIGHT** menu. Press the "ON ▲" button to enter the **DIM** menu.
2. Press the "MODE ▲" button in the submenu to scroll through COLOR - LOOP - EXIT screens.
3. Press the "ON ▲" or the "OFF ▼" button in the DIM submenu to change the light intensity from brightest to off. Press the "MODE ▲" button to go from DIM to COLOR.
4. Press the "ON ▲" or the "OFF ▼" button in the COLOR submenu to change the light color. Press the "MODE ▲" button to go from COLOR to LOOP.
5. Press the "ON ▲" or the "OFF ▼" button in the LOOP submenu to change the speed of the color wheel from 3 being the fastest color sequence to no number stopping the loop. Press the "MODE ▲" button to go from LOOP to EXIT.
6. Press the "ON ▲" in EXIT to go back into the **TOOLS** Menu.

SUMMER MODE

Your **CALDERA** spa is equipped with a Summer Mode timer. The Summer Mode timer can be activated during extremely hot summer months if it becomes difficult to maintain water temperatures low enough for comfort. When you turn on the Summer Mode timer, the heater will immediately shut down while the circulation pump (which can add heat to the water through normal operation) will remain on for approximately 5 minutes for heater cool-down. Both the heater and circulation pump will remain off for the next 8 hours. The summer mode icon on the main control panel will illuminate and remain illuminated for as long as the summer mode timer is on. Following this 8-hour period, the circulation pump, heater, and ozone will continue to turn off for an 8-hour period every day that the Summer Mode timer is on. The continual 8-hour shutdown minimizes the amount of heat transferred to the spa water. When the outside temperature begins to cool, the Summer Mode timer should be turned to the OFF position (the summer mode icon on the main control panel turns off). This is the efficient 24-hour circulation mode that keeps the heater operation and operating costs to a minimum during colder/heavier usage months.

IMPORTANT: The Summer Mode will not lower the spa's water temperature below the ambient air temperature.

To activate the Summer Mode, follow these steps:

1. Set the temperature control to 80°F (26°C). On the control panel press the "MODE ▼" button until the **TOOLS** menu is displayed. Then press the "ON ▲" button to enter the **TOOLS** submenus. Press the "MODE ▼" button until **SUMMR** is displayed on the screen. Press the "ON ▲" button to activate the Summer Timer mode. A small sun icon (bottom left corner of the display) indicates the Summer Mode is on. The Summer Mode must be deactivated when cooler temperatures return. To do this, simply follow step 2.
2. To turn the Summer Mode off, press the "MODE ▼" button until the **TOOLS** menu is displayed. Then press the "ON ▲" button to enter the **TOOLS** submenus. Press the "MODE ▼" button until **SUMMR** is displayed on the screen. Press the "OFF ▼" button to deactivate.



AUTOMATIC CLEAN DAILY CYCLE

Your spa is equipped with a Clean Daily Cycle, this feature when enabled will turn on the jets in a preset sequence for 10 minutes every day at the same time.

To activate the Clean Daily Cycle the follow is required:

- On the control panel press the "MODE ▼" button until the **TOOLS** menu is displayed. Then press the "ON ▲" button to enter the **TOOLS** submenus. Press the "MODE ▼" button until the **CLND** - symbol is displayed on the screen. Press the "ON ▲" button to activate the Clean Daily Cycle (**CLND +**). The jets will then run in a preset sequence for 10 minutes and come on every day at the same time. During the cycle the Jets icon will flash. Press the "OFF ▼" button to deactivate.

OPERATING INSTRUCTIONS

AUDIO CONTROL (OPTIONAL WIRELESS SYSTEM ONLY)

The following applies to spas that have an optional Aquatic Melodies® wireless multi-source audio system installed:

When the wireless audio system has been installed on the spa, the control panel can be used to control the music system. The following information demonstrates how to navigate through the audio menu by using the spa's main control panel.

AUDIO MENU

Once the audio system is installed, an AUDIO menu will be accessible on the control panel screen.

To access the menu, press the "MODE ▲" or "MODE ▼" buttons on the control panel until AUDIO is displayed.



BASIC CONTROL PANEL OPERATION

To enter into a sub-menu, or to adjust the current function displayed, use the "ON ▲" or "OFF ▼" buttons.

To move to the next sub-menu use the "MODE ▲" or "MODE ▼" buttons.

To exit from any sub-menu, press "MODE ▲" as many times as necessary until EXIT is displayed then press the "ON▲" button to exit that sub-menu.

TO TURN AUDIO SYSTEM ON/OFF

From the AUDIO menu:

1. Press the ON ▲ button to display POWER.
2. Press the ON ▲ button to display POWER + and turn the audio system ON. Press the OFF ▼ button to display POWER - and turn the audio system OFF. **Audio power must be ON (+) to advance to the other audio screens.**
IMPORTANT: The power can take a few seconds to turn on or off.



TO ADJUST VOLUME

From the AUDIO menu:

1. Press the ON ▲ button to display POWER+.
2. Press the MODE ▲ button to display VOL.
3. Press the ON ▲ button to increase volume and the OFF ▼ button to decrease volume.

NOTE: Volume range is from 1-40. No number displayed indicates Volume is OFF



TO PAUSE/PLAY (SONG)

From the AUDIO menu:

1. Press the ON ▲ button to display POWER+.
2. Press the MODE ▲ button to display VOL.
3. Press the MODE ▲ button to display PLAY.
4. Press the ON ▲ button to enter PLAY mode.
5. Press ON ▲ button to start or stop the song.



TO CHANGE TRACK (SONG)

From the AUDIO menu:

1. Press the ON ▲ button to display POWER+.
2. Press the MODE ▲ to display VOL.
3. Press the MODE ▲ button to display PLAY.
4. Press the MODE ▲ to display TRACK
5. Press the ON ▲ button to enter TRACK mode.
6. Press either ON ▲ or OFF ▼ button to change the track (song).



TO GO TO SETUP MENU

From the AUDIO menu:

1. Press the ON ▲ button to display POWER+.
2. Press the MODE ▲ to display VOL.
3. Press the MODE ▲ to display PLAY (if iCast is installed).
4. Press the MODE ▲ to display TRACK (if iCast is installed).
5. Press the MODE ▲ button to display SETUP.



OPERATING INSTRUCTIONS

TO CHANGE AUDIO SOURCE

From the SETUP menu:

1. Press the ON ▲ button to display one of four audio sources, IPOD,TV, AUX, BLUE
2. Press the ON ▲ button to raise to the next source or press OFF ▼ button to lower to the next source. Go to the source you will be using. **NOTE:** Blue = Bluetooth. To use the Bluetooth screen, your audio Bluetooth device must be paired with the spa. On your device, find *My Spa*. If you do not see this on your device you may be too far away from spa or your Audio Source is not set to BLUE. Pair your device and you will be ready to use the Bluetooth. Audio must be On to use Bluetooth. Only one paired Bluetooth device will work at a time.



TO ADJUST TREBLE

From the SETUP menu:

1. Press the ON ▲ button to display one of four audio sources, IPOD,TV, AUX, BLUE
2. Press the MODE ▲ button to display TRE -5 to +5.
3. Press the ON ▲ button to raise the Treble or press OFF ▼ button to lower the treble.



TO ADJUST BASS

From the SETUP menu:

1. Press the ON ▲ button to display one of four audio sources, IPOD,TV, AUX, BLUE
2. Press the MODE ▲ to display TRE.
3. Press the MODE ▲ button to display BAS -5 to +5.
4. Press the TEMP ▲ button to raise the Bass or press OFF ▼ button to lower the Bass.



TO ADJUST BALANCE

From the SETUP menu:

1. Press the ON ▲ button to display one of four audio sources, IPOD,TV, AUX, BLUE
2. Press the MODE ▲ button to display TRE.
3. Press the MODE ▲ button to display BAS.
4. Press the MODE ▲ button to display BAL -5 to +5.
5. Press the ON ▲ button to raise the Balance # or press OFF ▼ button to lower the Balance #.



TO ADJUST SUBWOOFER

From the SETUP menu:

1. Press the ON ▲ button to display one of four audio sources, IPOD,TV, AUX, BLUE
2. Press the button to display TRE.
3. Press the MODE ▲ button to display BAS.
4. Press the MODE ▲ button to display BAL.
5. Press the MODE ▲ button to display SUB 0 to 11.
6. Press the ON ▲ button to raise the subwoofer # or press OFF ▼ button to lower the subwoofer #.



TO CHANGE AMPLIFIER CHANNEL (TO MATCH WIRELESS DOCK TRANSMITTER INSIDE HOUSE IF INSTALLED)

From the SETUP menu:

1. Press the ON ▲ button to display one of four audio sources, IPOD,TV, AUX, BLUE
2. Press the MODE ▲ button to display TRE.
3. Press the MODE ▲ button to display BAS.
4. Press the MODE ▲ button to display BAL.
5. Press the MODE ▲ button to display SUB.
6. Press the MODE ▲ button to display CHAN 1-5.
7. Press the ON ▲ button to raise the channel # or press OFF ▼ button to lower the channel #.

NOTE: Channel number must match Transmitter number inside house to work properly.



EQUIPMENT COMPARTMENT

JET PUMP SIDE

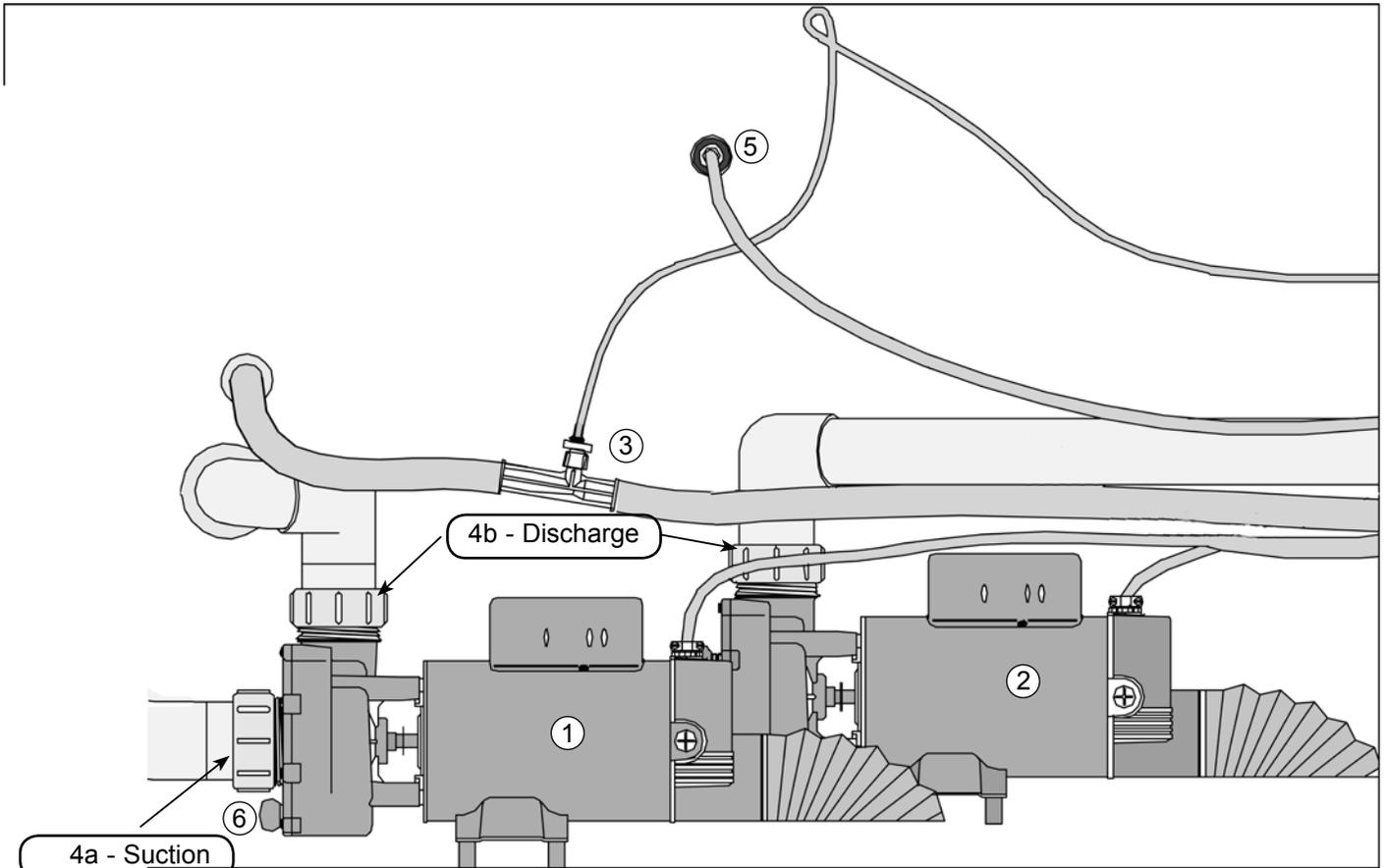

MAKENA, SALINA and MARTINIQUE

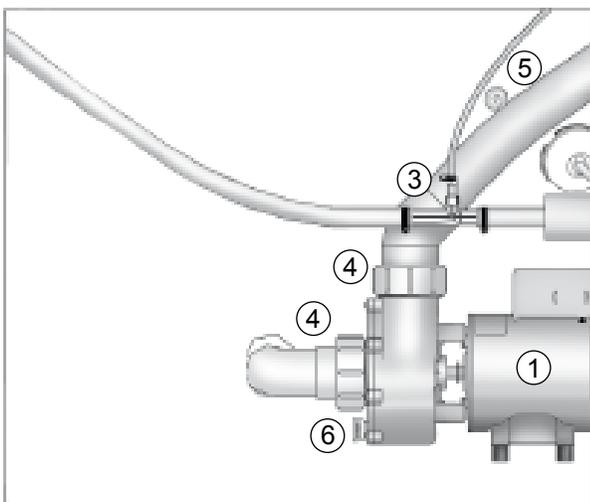

KAUAI

1. Jet Pump
2. Jet Pump **MAKENA, SALINA & MARTINIQUE** only)
3. Ozone Injector (Included with the Optional **MONARCH** CD Ozone Generator kit)
4. Unions
5. Temperature Sensor
6. Pump Drain Plug

EQUIPMENT COMPARTMENT

CONTROLS SIDE

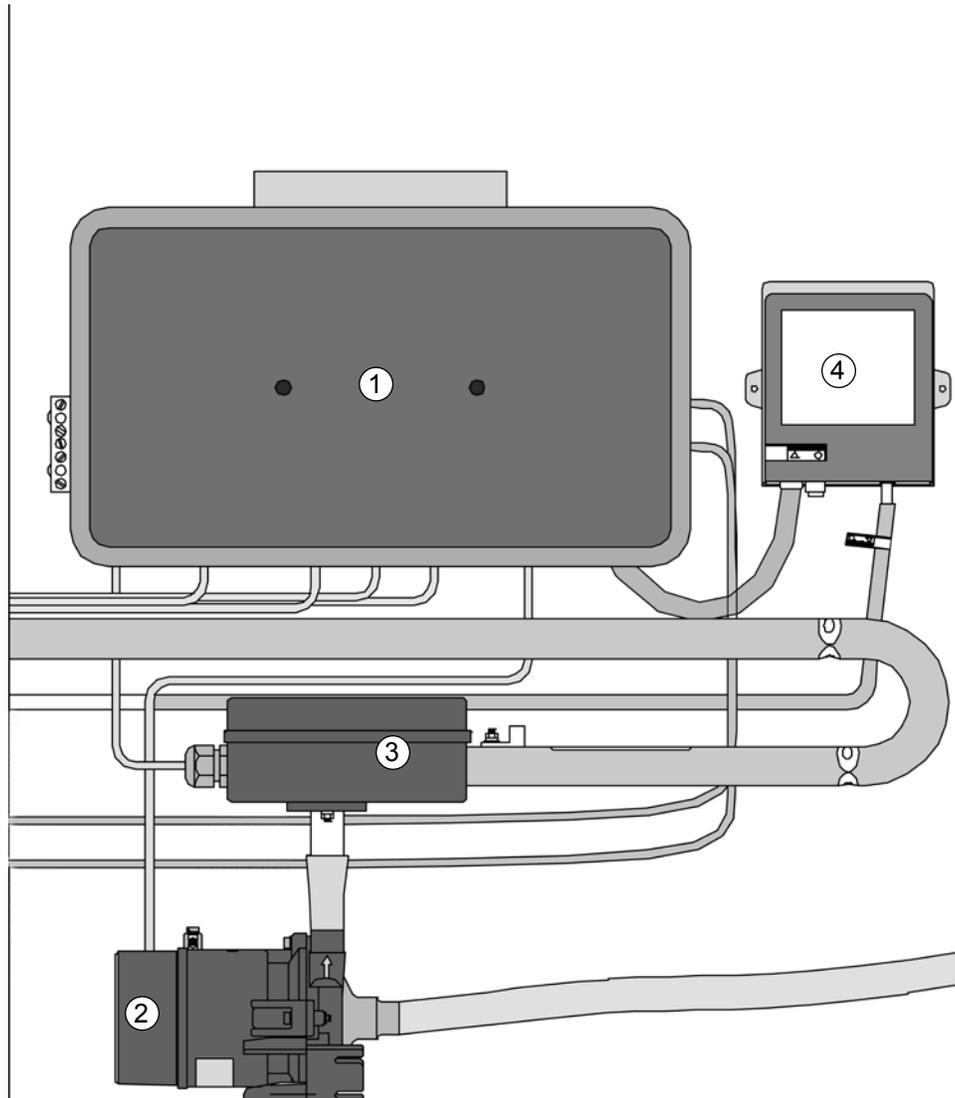

1. Advent® Control Box System
2. EnergyPro® Circulation Pump
3. **ENERGYPRO** Heater
4. **MONARCH** CD Ozone Generator (optional)

MAINTENANCE

FILTER MAINTENANCE

At least once a week, check and clean the skimmer basket and weir to ensure proper filter flow. Remove leaves, foreign matter, and debris. It is very important to keep your spa filter cartridge clean and free of particles to ensure proper water flow. A clean filter permits the hydrotherapy system to function properly and also allows more efficient filter cycles. Depending on how frequently your spa is used, we recommend cleaning the spa filter cartridge every four weeks. If this is not done, the filter may clog and restrict water flow, which causes improper filtration and poor jet performance.

IMPORTANT: The frequency and duration of use, and the number of occupants all contribute to determining the appropriate time between filter cleanings. More use means that more frequent filter cleanings will be required.

FILTER CARTRIDGE REMOVAL AND CLEANING

INSTRUCTIONS (USE MONARCH FILTER CLEANER)

1. Turn off power to the spa.
2. Push the filter basket down slightly and turn counter-clockwise to unlock. Then pull out the basket and weir.
3. Carefully pull up the filter cartridge and bring it out of the spa.
4. Always clean the filter using a filter degreaser to remove mineral and oil build-up. Soak the filter in the degreaser (according to the package directions). Then place the filter on a clean surface and, using a garden hose, spray until it is clean. It may be necessary to rotate the filter while spraying to remove any debris lodged between the filter pleats.
5. Replace the cartridge in the spa. To return the basket and weir, insert and rotate clockwise to lock into position.
6. Turn on power to the spa.

NOTE: Replacement filter cartridges are available from your **CALDERA** dealer. Refer to the back of this manual to determine the appropriate size for your spa.

DIVERTER VALVE MAINTENANCE

If your spa's diverter valves become difficult to turn, it is likely that sand or grit has become lodged inside the valve body. It is very important that this debris is removed as soon as possible to avoid damage to the valve. To clean the valves, follow these steps:

1. Turn off power to the spa.
2. Remove the diverter valve's handle by pulling upward while rocking it back and forth.
3. Unscrew the cap ring.
4. Remove the valve body by pulling it upward.
5. Wipe the valve body and the interior walls of the valve clean.
6. Lubricate the o-rings with a waterproof lubricant available from your **CALDERA** dealer.
7. Reassemble the valve and turn on power to the spa.

VERSASSAGE JETS MAINTENANCE

If the **VERSASSAGE** jets spin slower than when the spa was new, or the jets are sticking, it may be due to a build-up of deposits inside the jet bearings. To remove the deposits, follow these instructions:

1. With the spa off, rotate the **VERSASSAGE** jet face counter-clockwise until it stops.
2. Once the face stops rotating, use a little extra force to rotate the face counter-clockwise past the locking position until it stops. Pull the face away from the spa.
3. After flushing the bearings inside the body with water, spin the rotating nozzle. It should spin freely. If it does not, place the bearing end in a cup of vinegar (the vinegar will soften any deposits). Let it soak overnight. The next day, flush with water and repeat the spin test.
NOTE: If it still doesn't spin freely, then a second night of soaking is required. Replace the jet if the bearing still does not spin.
4. To replace, position the face body downward and push the face body back into the jet fitting. Slightly rotate face body in either direction until you feel the body align with the fitting, and then press firmly on the face. Once seated, rotate the face clockwise using a little extra force to overcome the locking position. If the face does not rotate, remove and rotate the face 180°, and repeat this step.
5. Turn the jet pump on. The **VERSASSAGE** jet should spin freely.

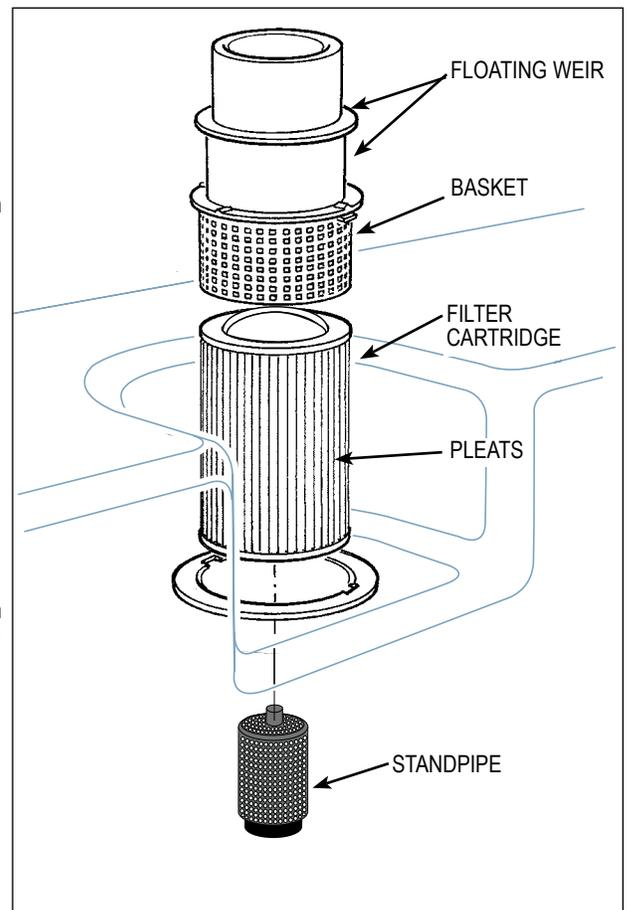

MAINTENANCE

DRAINING YOUR SPA

1. Turn off all GFCI breakers in sub-panel, or main electrical panel.
2. Locate the main drain valve for the spa. Pull on handle (Step 1) until you reach the mid position (Step 2) then rotate handle slightly to fully extended drain tube (drain cap and 1" of the drain tube is exposed) then remove the drain cap (Step 3) . **NOTE:** You will not be able to remove drain cap in mid position. Attach the garden hose to the end of the drain (step 4) making sure not to push the drain tube inward. Route the outlet of the hose to an appropriate draining area.

NOTE: Spa water with a high sanitizer level may harm plants and grass.

3. Push the garden hose and drain tube half way back towards the spa (Step 4) which will start the gravitational flow. Drain tube must be in the mid position for the spa to drain.

IMPORTANT: All models will drain almost completely through the drain valve. Equipment such as the jet pump and heating system will drain. Any water remaining within the plumbing or equipment after draining will only need to be removed if the spa is being winterized.

4. After your spa is empty, clean the shell and filter cartridge.
5. Pull and remove garden hose, replace drain cap and push drain tube back into spa as seen in Step 1.
6. Follow the "START-UP AND REFILL PROCEDURES" to refill your spa.

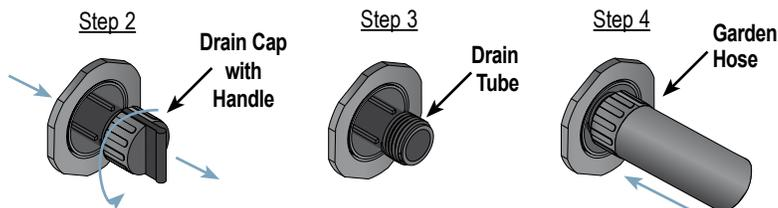
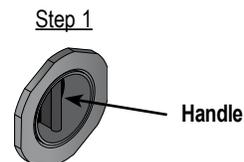
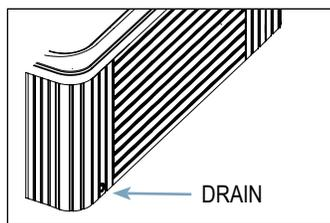

PREVENTION OF FREEZING

Your spa has been designed and engineered for year-round use in any climate. In some areas, extremely cold temperatures (below 10°F) combined with strong wind, may cause partial freezing of the jet pump, even though the water inside the spa remains at the selected temperature. The energy efficiency of the spa may also decrease during these cold periods, as the heater will cycle more frequently. As an additional precaution against partial freezing of some of the components, the equipment compartment can be insulated with an insulating kit (available from your local dealer). This insulating kit will also help to maximize the spa's energy efficiency.

NOTE: When warmer weather returns (approx. 60°-70°F), the insulating kit must be removed to prevent overheating of the jet pump.

WINTERIZING YOUR SPA

If you leave the spa unused for a long period of time in severely cold weather, you should drain the spa and winterize it to avoid accidental freezing due to a power or equipment failure. Follow these directions:

DANGER: Use only Propylene Glycol as your anti-freeze (available at most RV or marine supply stores). This is non-toxic. Never use an automobile anti-freeze (Ethylene Glycol) since it is toxic!

WARNING: Failure to follow these instructions correctly can lead to freeze damage not covered by warranty. It is strongly recommended that you contact your local dealer to perform this service.

1. Drain your spa according to the instructions in the "Draining Your Spa" section in the owner's manual.
2. Remove the filter cartridge, clean and store in a dry place.

IMPORTANT: These additional instructions must be utilized when draining and winterizing your spa in climates where the temperature falls below 32°F (0°C). A five (5) gallon combination (vacuum/blower) wet/dry shop vac must be used to effectively remove water that is trapped inside the plumbing lines.
3. Attach the vacuum hose to the vacuum side of the shop vac. Vacuum all openings and orifices as follows:
 - a) Jet openings: start with the jets at the top and move downward (if suction is coming from another jet, block off the other jet using a large rag – this will help pull out the water that is trapped deeper inside the main line).
 - b) Filter suction fittings and filter compartment.
 - c) Main drain outlet (it may be necessary to cover the drain grate tightly with a rag when vacuuming the main drain to ensure water is drawn completely from the internal plumbing system).
4. Thoroughly dry the spa shell with a clean towel.
5. Remove pump doors by first removing the drain collar then the door screws. Once door is removed unscrew the pump drain plugs located on the front of the pump housing. Allow all water to drain out. Place the drain plugs in a ziplock bag and store near the pumps. Replace the drain plugs on Start-up.
6. Unscrew the pump unions and allow the water to drain. Loosen and remove hose attached to circulation pump to allow any remaining water from heater and spa to drain out. Replace circulation pump hose once water is drained. **NOTE:** Tighten the pump unions prior to filling the spa.

MAINTENANCE

7. Replace the main drain cap.
8. Using a long-extension funnel, pour anti-freeze into all standpipes, filter suction fittings, jet orifices and water feature orifices. Also, add anti-freeze to the **FROG** injector. Add enough anti-freeze to ensure adequate protection – in many cases, you will see the liquid in the orifice, or coming out of another location.
CAUTION: Use only Propylene Glycol as your anti-freeze. This is non-toxic. Never use an automobile anti-freeze (Ethylene Glycol) since it is toxic!
9. Close the spa cover and fasten the cover tie downs. Cover the spa cover with two pieces of plywood to evenly distribute the weight of snow and ice. Secure a plastic sheet, or tarp, over the spa cover and plywood.
10. Replace the equipment access door, if removed.

OPENING INSTRUCTIONS:

1. Remove plywood and plastic sheet. Open the spa cover by unfastening the cover tie downs.
2. Follow the Start-up and Refill Procedures in the Operating Instructions section of the Owner's Manual. Do not install filters to prevent them from exposure to the anti-freeze.
3. As part of this process, superchlorinate the spa water by adding three teaspoons of chlorine (sodium dichlor) per 250 gallons of spa water into the filter compartment. This is twice the normal amount of chlorine needed for superchlorination. This extra amount of chlorine is needed to destroy the anti-freeze.
NOTE: A defoamer may be needed to decrease the amount of foam caused by the anti-freeze.
4. Drain your spa to ensure removal of anti-freeze. Do not drain water on grass or plants due to excessive chlorine level.
5. After the spa has completely drained, re-install your filter and follow the Start-up and Refill Procedures in the Operating Instructions section of the Owner's Manual.
IMPORTANT: Always keep spa covered when not in use, whether it is empty or full.

CARE OF THE SPA PILLOWS

The spa pillows will provide years of comfort if treated with care. They have been positioned above the water level to minimize the bleaching effects of chlorinated water and other spa water chemicals. To extend their life, whenever the spa shell is being cleaned, the spa pillows should be removed and cleaned. Body oils can be removed with a mild soap and water solution. ALWAYS rinse off the spa pillows thoroughly to remove any soap residue. If the spa is not going to be used for a long period of time (that is during a vacation or if the spa is winterized), or when the spa water is being super-chlorinated, the spa pillows should be removed until the next use of the spa.

TO REMOVE AND REPLACE THE SPA PILLOWS:

1. Carefully lift one end of the pillow away from the spa shell.
2. Continue lifting one end until all pillow retainers are released from the pillow.
IMPORTANT: Just pulling the pillow straight up and out of the shell recess will eventually damage the pillow. This abuse is not covered under warranty.
3. To reinstall the spa pillow, remove the insert then carefully bend the pillow slightly to allow one of the pillow retainers to slip into the recess in the back of the pillow.
4. Keeping the pillow slightly bent, slide the other pillow retainer into the recess in the back of the pillow.
5. After all the pillow retainers are in place, press the pillow down into the recess in the spa shell, then place insert back into center of the pillow.

CARE OF THE EXTERIOR

SPA SHELL

Your **CALDERA** spa has an acrylic shell. Stains and dirt generally will not adhere to your spa's surface. A soft rag or a nylon scrubber should easily remove most dirt. Most household chemicals are harmful to your spa's shell (see below for detailed information on cleaning agents). Always rinse off any spa shell cleaning agent with fresh water.

IMPORTANT:

1. The following products are the **ONLY** approved cleaning agents for your **CALDERA** spa shell: plain water, **CALDERA** Spa Shine, Brilliantize® or Soft Scrub®. The use of alcohol or any other household cleaner other than those listed to clean the spa shell surface is **NOT** recommended. **DO NOT** use any cleaning products containing abrasives or solvents since they may damage the shell surface, specifically: Simple Green®, Windex® or Spa Mitt. **NEVER USE HARSH CHEMICALS!** Damage to the shell by use of harsh chemicals is not covered under the warranty. Always rinse off any spa shell cleaning agent with fresh water.
2. Iron and copper in the water can stain the spa shell if allowed to go unchecked. Ask your **CALDERA** dealer about a Stain and Scale Inhibitor to use if your spa has a high concentration of dissolved minerals. (Watkins recommends Stain & Scale Defense.)
3. Keep all cleaners out of the reach of children and use care when applying.

MAINTENANCE

ECOTECH® SPA CABINET

The **ECOTECH** cabinet consists of rigid polymers that combine the durability of plastic, with the beauty of wood. **ECOTECH** is resistant to cracking, peeling, blistering, and delaminating even after prolonged exposure to the elements.

Cleaning your **ECOTECH** cabinet is as easy as spraying the cabinet with a mild soap and water solution to remove any stains and residue.

CARE OF THE SPA COVER

⚠ **WARNING:** The cover is a manual safety cover that meets or exceeds all prevailing requirements of ASTM Standards for spa safety covers when installed and used correctly as of the date of manufacture. Non-secured or improperly secured covers are a hazard. Open the cover to its fully open position before use.

VINYL COVER

The vinyl spa cover is an attractive, durable foam insulation product. Monthly cleaning and conditioning are recommended to maintain its beauty.

TO CLEAN AND CONDITION THE VINYL COVER:

1. Remove the cover from the spa and gently lean it against a wall or fence.
2. With a garden hose, spray the cover to loosen and rinse away dirt or debris.
3. Using a large sponge and/or a soft bristle brush and a very mild soap solution (1 teaspoon dishwashing liquid with 2 gallons of water) or baking soda (sodium bicarbonate), scrub the vinyl top in a circular motion. Do not let the vinyl dry with a soap film on it before it can be rinsed clean.
4. Scrub the cover's perimeter and side flaps. Rinse clean with water.
5. Rinse off the underside of the cover with water only (don't use soap), and wipe it clean with a dry rag.
6. Use MONARCH Cover Shield to protect the cover.

SERVICE NOTE: To remove tree sap, use cigarette lighter fluid (not charcoal lighter fluid). Use sparingly. Rinse with a saddle soap solution immediately afterwards, and then wipe dry.

IMPORTANT REMINDERS:

- **DO** remove snow buildup to avoid breakage of the foam core from the additional weight of the snow.
- **DO** lock cover lock straps to secure the cover when the spa is not in use.
- **DO NOT** drag or lift the spa cover using either the flaps or the cover lock straps.
- **DO NOT** walk, stand, or sit on the cover.
- **DO NOT** place any metal or heat transferring object on the cover or place any type of plastic tarp or drop cloth over the cover as this may result in a melted foam core, which would not be covered under the warranty.
- **DO NOT** use any lifting mechanisms, chemicals or cleaners except those recommended by Watkins Manufacturing Corporation or its Authorized Sales and Service Dealer.

WATER QUALITY AND MAINTENANCE

It's important to have clean water. Water maintenance is one of the least understood, yet most important areas of spa ownership. Your dealer can guide you through the process of achieving and maintaining perfect water in your spa, given your local conditions. Your program will depend on your water's mineral content, how often you use your spa, and how many people use it.

WATER TERMINOLOGY

The following chemical terms are used in this Water Quality and Maintenance section. Understanding their meaning will help you to better understand the water maintenance process.

Bromamines: Compounds formed when bromine combines with nitrogen from body oils, urine, perspiration, etc. Unlike chloramines, bromamines have no pungent odor and are effective sanitizers.

Bromine: A halogen sanitizer that is commonly used in stick, tablet, or granular form. The **FROG** sanitizing system is the only solid bromine-approved system. See the DO's and DON'Ts of Spa Water Maintenance for additional information.

Calcium Hardness: The amount of dissolved calcium in the spa water. This should be approximately 50-150 ppm. High levels of calcium can cause cloudy water and scaling. Low levels can cause harm to the spa equipment.

Chloramines: Compounds formed when chlorine combines with nitrogen from body oils, urine, perspiration, etc. Chloramines can cause eye irritation as well as having a strong odor. Unlike bromamines, chloramines are weaker, slower sanitizers.

Chlorine: An efficient sanitizing chemical for spas. Watkins Manufacturing Corporation recommends the use of sodium dichlor-type granulated chlorine. This type is preferred because it is totally soluble and nearly pH neutral.

Chlorine (or Bromine) Residual: The amount of chlorine or bromine remaining after chlorine or bromine demand has been satisfied. The residual is, therefore, the amount of sanitizer which is chemically available to kill bacteria, viruses and algae.

Corrosion: The gradual wearing away of metal spa parts, usually caused by chemical action. Generally, corrosion is caused by low pH or by water with levels of TA, CH, pH or sanitizer which are outside the recommended ranges.

DPD: The preferred reagent used in test kits to measure the Free Available Chlorine.

Halogen: Any one of these five elements: fluorine, chlorine, bromine, iodine, and astatine.

MPS: Monopersulfate is a non-chlorine oxidizer.

Oxidizer: The use of an oxidizing chemical is to prevent the buildup of contaminants, maximize sanitizer efficiency, minimize combined chlorine and improve water clarity.

Ozone: Ozone is a powerful oxidizing agent which is produced in nature and artificially by man. Ozone forms no by-products of chloramines (ozone actually oxidizes chloramines) and will not alter the water's pH.

Pathogen: A microorganism such as bacterium that cause disease.

pH: The measure of the spa water's acidity and alkalinity. The recommended pH for the spa water is 7.2 to 7.6. Below 7.0 (considered neutral), the spa water is too acidic and can damage the heating system. Above 7.6, the water is too alkaline and can result in cloudy water, and scale formation on the shell and heater.

ppm: The abbreviation of "parts per million", the standard measurement of chemical concentration in water. Identical to mg/l (milligrams per liter).

Reagent: A chemical material in liquid, powder, or tablet form for use in chemical testing.

Sanitizer: Sanitizers are added and maintained at recommended residuals to protect bathers against pathogenic organisms which can cause disease and infection in spa water.

Scale: Rough calcium-bearing deposits that can coat spa surfaces, heaters, plumbing lines and clog filters. Generally, scaling is caused by mineral content combined with high pH. Additionally, scale forms more readily at higher water temperatures.

Shock Treatment: Also known as "super-chlorination" when chlorine is used. Shock treatment is a process of adding significant doses of a quick dissolving sanitizer (sodium dichlor is recommended) to oxidize non-filterable organic waste and to remove chloramines and bromamines.

Total Alkalinity: The amount of bicarbonates, carbonates, and hydroxides present in spa water. Proper total alkalinity is important for pH control. If the TA is too high, the pH is difficult to adjust. If the TA is too low, the pH will be difficult to hold at the proper level. The desired range of TA in spa water is 40 to 120 ppm.

GENERAL INFORMATION

THE THREE FUNDAMENTAL AREAS OF WATER MAINTENANCE:

- **WATER FILTRATION**
- **CHEMICAL BALANCE/PH CONTROL**
- **WATER SANITATION**

Water sanitation is the responsibility of the spa owner. To properly sanitize the spa, Watkins highly recommends the **FROG** water care system. This system will chemically control the bacteria and viruses present in the fill water or introduced during use of the spa. Bacteria and viruses can grow quickly in undersanitized spa water. The water's chemical balance and pH control are also the responsibility of the spa owner. You'll have to add chemicals to maintain proper levels of Total Alkalinity (TA), Calcium Hardness (CH) and pH. Proper water balance and pH control will minimize scale buildup, extend the life of the spa, and allow the sanitizer to work at an optimum level.

WATER QUALITY AND MAINTENANCE

METHODS FOR TESTING THE SPA WATER

Accurate water testing and analysis is an important part of effectively managing your spa water. You must have the ability to test for:

- Total Alkalinity (TA)
- Calcium Hardness (CH)
- pH
- Sanitizer

Two types of testing methods are recognized and recommended by Watkins Manufacturing Corporation:

1. **The Reagent Test Kit** is a method which provides a high level of accuracy. The reagents come in either liquid or tablet form.
2. **MONARCH Test Strips** are a convenient testing method used by many spa owners. Keep in mind that test strips are susceptible to heat and moisture contamination, which will result in inaccurate readings.

IMPORTANT: Always read and carefully follow the directions included with the Test Kit or Test Strips to ensure the accuracy of the test results.

BASIC CHEMICAL SAFETY

When using chemicals, read the labels carefully and follow directions precisely. Though chemicals protect you and your spa when used correctly, they can be hazardous in concentrated form. Always observe the following guidelines:

- Allow only a responsible person to handle spa chemicals. **KEEP THEM OUT OF THE REACH OF CHILDREN.**
- Accurately measure the exact quantities specified. Never use more. Do not overdose your spa.
- Handle all containers with care. Store in a cool, dry, well-ventilated place.
- Always replace the caps on their proper containers when not in use.
- Don't inhale fumes or allow chemicals to come in contact with your eyes, nose, or mouth. Wash your hands immediately after use.
- Follow the emergency advice on the product label in case of accidental contact, or if the chemical is swallowed. Call a doctor or the local Poison Control Center. If a doctor is needed, take the product container along with you so that the substance can be identified.
- Don't let chemicals get on surrounding surfaces or landscaping.
- Don't use a vacuum cleaner to clean up chemical spills.
- Never smoke around chemicals. Some fumes can be highly flammable.
- Don't store any chemicals in the spa equipment compartment.

HOW TO ADD CHEMICALS TO THE SPA WATER

IMPORTANT: All spa water chemicals (other than FROG cartridges), including MPS+ (shock), MONARCH chlorine, MONARCH granulated pH increaser or MONARCH decreaser, MONARCH granulated total alkalinity increaser, MONARCH calcium hardness increaser, MONARCH liquid stain and scale inhibitor, and MONARCH liquid de-foamer must always be added directly into or in front of the filter compartment while a jet pump is running, and it must run for a minimum of ten minutes.

TO ADMINISTER SPA WATER CHEMICALS:

1. Fold back the cover and remove the filter compartment cover.
2. To activate the Clean Cycle, press the "MODE ▲" or "MODE ▼" button until the **CLEAN** menu is displayed. Press the "ON ▲" button to activate the **CLEAN** cycle.
3. Carefully measure the recommended amount of chemical and slowly pour it over the filter basket area. Use care not to splash chemicals on your hands, in your eyes, on the spa sheet surface, or on the siding.
4. Replace the filter compartment cover. After ten minutes, shut off the jet pump(s) and close the cover. **Risk of Drowning:** Never leave an open spa unattended!

⚠ **WARNING:** High sanitizer levels can cause discomfort to the user's eyes, lungs and skin. Always allow the sanitizer level to fall to the recommended range before using the spa.

IMPORTANT NOTE ABOUT "SUPER CHLORINATION/NON-CHLORINE SHOCK TREATMENT": After administering a super chlorination treatment or non-chlorine shock to your spa, leave the cover open for a minimum of 20 minutes to allow the oxidizer gas to vent. A high concentration of trapped oxidizer gas which may exist as a result of the shock treatment (not daily sanitation) may eventually cause discoloration or vinyl degradation to the bottom of the cover. This type of damage is considered chemical abuse and is not covered under the terms of the limited warranty.

THE WATKINS SPA WATER MAINTENANCE PROGRAM

Each step in your water maintenance program is dependent on the completion of the previous steps. Omitting a step or failing to reach the recommended range may cause an imbalance in your water's chemistry. Unbalanced water chemistry can damage the spa and its components, as well as cause discomfort for the user.

BALANCING THE TOTAL ALKALINITY (TA)

- A. The recommended Total Alkalinity (TA) for your spa water is 40 - 120 ppm.
- B. Total Alkalinity is a measure of the total levels of carbonates, bicarbonates, hydroxides, and other alkaline substances in the water. TA is referred to as the water's "pH buffer". In other words, it's a measure of the ability of the water to resist changes in pH level.

WATER QUALITY AND MAINTENANCE

- C. If the TA is too low, the pH level will fluctuate widely from high to low. Fluctuations in pH can cause corrosion or scaling of the spa components. **Low TA can be corrected by adding sodium hydrogen carbonate (MONARCH pH/Alkalinity Up).**
- D. If the Total Alkalinity is too high, the pH level will tend to be high and may be difficult to bring down. **It can be lowered by using sodium bisulfate (pH/Alkalinity Down).**
- E. Once the TA is balanced, it normally remains stable, although the addition of more water with a high or low alkalinity will raise or lower the TA reading of the water.
- F. When the Total Alkalinity is within the recommended range, proceed to the next step.

BALANCING THE CALCIUM HARDNESS (CH)

- A. The recommended Calcium Hardness (CH) level for your spa is 50 - 150 ppm.
- B. Calcium Hardness is a measure of the total amount of dissolved calcium in the water. Calcium helps control the corrosive nature of the spa's water. That's why calcium-low water (commonly known as "soft" water) is not recommended. It is very corrosive to the equipment, and can cause staining of the spa shell.
- C. If the CH is too high (commonly known as "hard water"), formation of scale on the spa's shell surface and equipment can result. Watkins Manufacturing Corporation recommends using the Vanishing Act™ Calcium Remover to remove hardness from water. **CH can also be decreased by dilution—a mixture of 75% hard and 25% soft water will usually yield a reading within the correct range.** If soft water is not available or practical for you, a stain and scale inhibitor should be added to the spa water, according to label instructions.
- D. If the CH is too low add **MONARCH CH** Increaser.
- E. Once the CH is balanced, it normally remains stable, although the addition of more water with a high or low calcium content will raise or lower the CH reading of the water.
- F. When the Calcium Hardness is within the recommended range, proceed to the next step.

| | | |
|--------------------------------------|-----|---------------------------------|
| ALKALINE SPA WATER (SCALING ZONE) | 8.2 | ADD pH DECREASER TO LOWER pH |
| | 7.8 | |
| COMFORT ZONE | 7.6 | IDEAL |
| | 7.4 | |
| | 7.2 | |
| ACIDIC SPA WATER (CORROSIVE ZONE) | 6.8 | ADD pH INCREASER TO RAISE pH |
| | pH | |

BALANCING THE PH

- A. The recommended pH level for your spa water is 7.2 - 7.6.
- B. The pH level is the measure of acidity and alkalinity. Values above 7.6 are alkaline; those below 7.2 are acidic. Maintaining the proper pH level is extremely important for:
 - Optimizing the effectiveness of the sanitizer.
 - Maintaining water that is comfortable for the user.
 - Preventing equipment deterioration.
- C. If the spa water's pH level is too low, the following may result:
 - The sanitizer will dissipate rapidly.
 - The water may become irritating to spa users.
 - The spa's equipment may corrode.

If the pH is too low, it can be increased by adding sodium hydrogen carbonate (pH/Alkalinity Up) to the spa water.

- D. If the pH level is too high, the following may result:
 - The sanitizer is less effective.
 - Scale will form on the spa shell surface and the equipment.
 - The water may become cloudy.
 - The filter cartridge pores may become obstructed.

If the pH is too high, it can be decreased by adding sodium bisulfate (MONARCH pH/Alkalinity Down) to the spa water.

NOTE: After adding sodium hydrogen carbonate or sodium bisulfate, **wait two hours** before testing the water for pH. Measurements taken too soon may not be accurate.

- E. It is important to check the pH on a regular (weekly) basis. The pH will be affected by the bather load, the addition of new water, the addition of various chemicals, and the type of sanitizer used.
- F. When the pH is within the recommended range, proceed to the final step.

MAINTAINING THE SANITIZER LEVEL

- A. Sanitizer is extremely important for killing algae, bacteria and viruses, and preventing unwanted organisms from growing in the spa. At the same time, you don't want too high a sanitizer level, or it can irritate your skin, lungs, and eyes.
- B. Always maintain the sanitizer level in your spa at the recommended level for each type of sanitizer.
- C. Watkins recommends the following sanitizer:
 - **FROG** sanitizing system (mineral and bromine)
- D. Watkins also approves the following sanitizers:
 - Sodium Dichloro-s-Triazinetrione (sodium dichlor or chlorine)
 - Biguanide

⚠ **WARNING:** DO NOT use tri-chlor chlorine or any type of compressed bromine or chlorine, acid or any type of sanitizer which is not recommended by Watkins Manufacturing Corporation.

WATER QUALITY AND MAINTENANCE

| THE WATKINS WATER MAINTENANCE QUICK REFERENCE GUIDE | | | | |
|--|---|-------------|--|--|
| Steps | Ideal Range (ppm) | | What Chemicals to Use | |
| | Min. | Max. | To Raise | To Lower |
| 1 Total Alkalinity | 40 | 120 | Sodium Hydrogen Carbonate or Sodium Bicarbonate | Sodium Bisulfate |
| 2 Calcium Hardness | 50 | 150 | Calcium Hardness Increaser | Use a mixture of 75% hard water and 25% soft water or use a Stain and Scale Inhibitor |
| 3 pH | 7.2 | 7.6 | Sodium Hydrogen Carbonate | Sodium Bisulfate |
| 4 Sanitizer | See section on Maintaining the Sanitizer Level | | | |

FROG WATER CARE SYSTEM

The FROG Water Care system is comprised of the following two products:

THE FROG MINERAL CARTRIDGE. This cartridge introduces minerals into the spa water, inhibiting bacteria growth.

THE FROG BROMINE CARTRIDGE (BCDMH). The only recommended sanitizer that will work in conjunction with the FROG Mineral cartridge.

IMPORTANT: In addition to regularly testing and balancing your spa water, a weekly "shock treatment" is required. The shock treatment quickly destroys any remaining contaminants while revitalizing the bromine in the water.

To weekly "shock treat" your spa, we recommend that you use either **MONARCHMPS PLUS** or **MONARCH** sodium dichlor (chlorine). **MONARCH** sodium dichlor may be a more appropriate weekly shock for those users that experience heavy bather load conditions.

The following optional products can be used in conjunction with the FROG Water Care system:

MONARCH MPS PLUS NON-CHLORINE SHOCK (MPS/Monopersulfate) is an oxidizing chemical used to prevent the buildup of contaminants, maximize sanitizer efficiency, and improve water clarity. When used in conjunction with the FROG system it oxidizes particulates in the spa water.

IMPORTANT NOTE: **MONARCH MPS PLUS** is an oxidizer, not a sanitizer.

MONARCH CORONA DISCHARGE (CD) OZONE is a high output ozone system and is the only ozone purification system approved for installation in your **CALDERA** Spa. The **MONARCH** ozone system utilizes CD technology to produce a **higher concentration of ozone than is produced by a competing chip style CD or ultraviolet light ozone systems.**

NOTE: Refer to the **Start-Up instructions on page 12** or your **FROG owner's manual for start-up and operation instructions.** The owner's manual can be found with your FROG starter kit.

It is important to follow the recommended application and maintenance programs outlined for each product's use. If the spa is being used over an extended period or time, such as a whole afternoon or evening, additional sanitizer will be needed.

NOTE: The FROG Mineral Cartridge is not approved for use in Canada.

NOTE: For Canada, if you are only using the bromine cartridge, your bromine levels should be between 3.0 - 5.0 ppm.

FROG CARTRIDGE REPLACEMENT INSTRUCTIONS

The FROG bromine cartridge should be replaced every 2-4 weeks, depending on User Load. The FROG mineral cartridge should be replaced every 4 months. When replacing the mineral cartridge, it is highly recommended that the spa be drained and refilled at the same time. After refilling the spa with water, balance the Total Alkalinity (TA), Calcium Hardness (CH) and pH to the recommended levels. Shock the spa by adding **MONARCH MPS PLUS** non-chlorine shock or sodium dichlor (chlorine), then replace the cartridges.

To replace FROG cartridges, follow these steps:

1. Turn off power to the spa
2. Unscrew FROG cap on top edge of spa
3. Turn handle counter-clockwise
4. Lift cartridge holder up and out of spa
5. Remove and discard old cartridges
6. Turn top cap of new Mineral cartridge to setting #6 (evaluate water in 1 week and adjust as necessary).
7. Turn top cap of new Bromine cartridge to setting #6 (measure Bromine with Bromine Test Strip in 1 week and adjust as necessary).
8. Snap bromine cartridge into the bottom of holder and snap mineral cartridge into the top
- IMPORTANT:** It is important that the bromine cartridge is on the bottom; otherwise, the bromine cartridge could dispense prematurely.
9. Reinstall cartridge holder into spa, push down, and twist clockwise.
10. Replace FROG cap
11. Reconnect power to the spa

IMPORTANT NOTE: Adjust bromine cartridge setting down by one setting each day until a residual of 1.0 - 2.0 ppm level of bromine is established

⚠ **WARNING:** High sanitizer levels can cause discomfort to the user's eyes, lungs and skin. Always allow the sanitizer level to fall to the recommended range before using the spa.

WATER QUALITY AND MAINTENANCE

FOLLOWING THE FROG SANITIZER ROUTINE

During the first month of ownership, measure the sanitizer residual daily in order to establish the correct setting on cartridges for User Load and Usage Time versus Sanitizer Needed.

- **USER LOAD** is the spa is the number of times anyone **enters** the spa.
- **USAGE TIME** is simply the amount of time a user **spends** in the spa.
- **SANITIZER NEEDED** is the amount needed to accommodate the number of users and their combined usage time.

For example, two spa users who regularly use the spa once an evening for twenty minutes create a specific and somewhat consistent demand on the sanitizer. During the first month of ownership, these two users can determine exactly how much sanitizer to use in order to maintain the proper residual. If, at any time, the user load and/or usage pattern changes dramatically (i.e. invited guests), the amount and frequency of sanitizer required increases dramatically. The greater the usage time, or the bather load, the faster the residual value is diminished.

DOS AND DON'TS

- **DO check your bromine chemical level prior to each use.**
- **DO change the FROG mineral cartridge every 4 months.**
- **DO test Total Alkalinity and pH weekly.**
- **DO use MONARCH MPS or MPS Plus® non-chlorine (Monopersulfate) oxidizer for spas only.**
- **DO store all chemicals in a tightly sealed container in a cool, dry place.**
- **DON'T use sodium bromide or biguanides. These are active sanitizers and will combine with the silver ions to inactivate them.**
- **DON'T use a water clarifier. Clarifiers will cause the spa water to become cloudy.**
- **DON'T use the MONARCH silver cartridge with FROG.**

BROMINE

- Sanitizing chemicals, such as bromine, are oxidants that kill bacteria and viruses in the water. If you are using the **FROG** system, the recommended bromine level for your spa water is 1.0 - 2.0 ppm. If you are not using the **FROG** system, your bromine level should be between 3.0 - 5.0 ppm. **NOTE: For Canada, if you are only using the bromine cartridge, your bromine levels should be between 3.0 - 5.0 ppm.**
- When not using the **FROG** system Watkins Manufacturing Corporation recommends the use of granulated bromine for sanitizing the water. Granulated bromine is preferred because it is totally soluble, dissolves quickly and is nearly pH neutral.
- Maintaining the proper level of bromine during use is extremely important.
- If the bromine level is too low, bacteria and viruses can grow rapidly in the warm water. Increase the FAC by adding granulated sodium dichlor.
- If the bromine level is too high, the water can cause discomfort to the user's eyes, lungs and skin. **Simply allow some time to pass in order for the bromine to dissipate.**
- When the bromine level is within the recommended range, the spa is ready to be enjoyed.

CHLORINE - SODIUM DICHLOR (USE MONARCH CHLORINE)

- Sanitizing chemicals, such as chlorine, are oxidants that kill bacteria and viruses in the water. The Free Available Chlorine (FAC) is a measure of the amount of unused chlorine available to sanitize the spa. The recommended FAC for your spa water is 3.0-5.0 ppm.
- Watkins Manufacturing Corporation recommends the use of **MONARCH** sodium dichlor type granulated chlorine for sanitizing the water. **MONARCH** Sodium dichlor is preferred because it is totally soluble, dissolves quickly and is nearly pH neutral.
- Maintaining the proper level of chlorine during use is extremely important.
- If the FAC is too low, bacteria and viruses can grow rapidly in the warm water. Increase the FAC by adding granulated sodium dichlor.
- If the FAC is too high, the water can cause discomfort to the user's eyes, lungs and skin. Simply allow some time to pass. The FAC level will drop naturally over time.
- When the Free Available Chlorine is within the recommended range, the spa is ready to be enjoyed.

| CHLORINE DPD TEST KIT OR TEST STRIP READING | DO NOT USE THE SPA UNTIL THE TEST KIT READING IS BELOW THIS LEVEL |
|---|---|
| 5.0 | RECOMMENDED LEVEL SAFE |
| 4.0 | |
| 3.0 | ADD CHLORINE |
| 2.0 | DO NOT USE SPA ; ADD CHLORINE TO REACH RECOMMENDED SAFE LEVEL |
| 1.0 | |
| 0 | |

SUPER CHLORINATION

Super Chlorination is a process used to eliminate chlorine smell (if you are using chlorine) by "burning-off" chloramines (used chlorine). This helps maintain the proper level of free chlorine.

When giving your water a super chlorination treatment, open the cover at least half way for twenty minutes to allow the chlorine gas to vent off. The high concentration of chlorine gas which may exist as a result of super chlorination (not daily sanitation) may eventually cause discoloration or degradation to the bottom of the cover, which would not be covered under the terms of your warranty.

WARNING: There are several forms of stabilized chlorine available for use in spas and swimming pools. Each form has specific chemical characteristics. It is extremely important that the form you choose is specifically designed for use in spas. Use of an incorrect product such as tri-chloro, which has a very low pH (2.6),

WATER QUALITY AND MAINTENANCE

dissolves too quickly in hot water resulting in extremely high levels of chlorine, and is designed for concrete or plaster swimming pools, WILL cause damage to your spa. Use of a liquid, or any type of compressed bromine or chlorine, acid, or any type of sanitizer which is not recommended by Watkins Manufacturing Corporation, WILL damage your spa and is specifically not covered under the terms of the limited warranty.

IMPORTANT: Granulated chlorine (sodium dichlor) will degrade if stored improperly. We recommend purchasing chlorine in one, two, or five pound containers and storing it in a cool, dry place to maintain its potency.

WARNING: Never leave an open spa unattended, especially if there are children present!

| WATKINS WATER TREATMENT GUIDE | |
|--|--|
| At spa startup or refill | Follow spa Start-Up and Refill Procedures. |
| Prior to each use (Test before adding any chemicals; do not add any chemicals if proper or higher levels are found.) | Add one-half (½) teaspoon of sodium dichlor per 250 gallons, OR Add one (1) tablespoon MONARCH MPS PLUS (monopersulfate)* per 250 gallons |
| Once a week | Add one-half (½) teaspoon of sodium dichlor per 250 gallons, OR Add three (3) tablespoons MONARCH MPS PLUS (monopersulfate)* per 250 gallons |
| Every four months | Drain spa, replace mineral cartridge, and refill your spa. Follow spa Start-Up and Refill Procedures. |
| If needed (If water is hazy, cloudy or has an odor) | Add one and one half (1-1/2) teaspoons of sodium dichlor per 250-gallons, as needed. |

* **MONARCH MPS PLUS** is an oxidizer, not a sanitizer

SUPPLEMENTAL WATER MAINTENANCE

Proper water sanitation and mineral balance (pH control) are absolutely essential for a complete spa water maintenance program. Here are two other popular water additives that are optional:

1. MINERAL DEPOSIT INHIBITORS (USE **MONARCH STAIN/SCALE**)

As water evaporates from your spa and new water is added, the amount of dissolved minerals will increase. (Minimize evaporation by keeping the cover on the spa whenever possible.) The spa water may eventually become "hard" (Calcium Hardness too high) enough to damage the heater by calcifying its surface. Proper pH control can minimize this.

Normal soap build-up will require water replacement regularly enough that mineral deposits normally are not a problem.

Occasionally, high iron or copper content in the water may produce green or brown stains on the spa. A stain and scale inhibitor may help to reduce these metals.

NOTE: Well water may contain high concentrations of minerals. The use of a low water volume, extra-fine pore water filter will help to remove many of the larger particles during the filling of the spa.

2. FOAM INHIBITORS (USE **MONARCH DEFOMER**)

Spa water requires changing due to the buildup of soap in the water. Typically, soap will cause the spa water to foam when the jets are used. Soap is introduced into the spa water from two sources: users' bodies, which retain a soap residue after showering, and swimming apparel, which retains soap after washing.

Foam inhibitors can suppress foam, but cannot remove soap from the water. Soap is very difficult to remove from the water because soap is not oxidized by any chemical added to the spa. Only ozone can oxidize soap.

Eventually the soap build-up in the water will be concentrated, resulting in an unclean feeling on the bather's skin, which is impossible to remedy. When this occurs, it's time to drain and refill the spa. Depending on the soap input, the water should last about 4 months before needing to be drained.

MONARCH OZONE SYSTEM (OPTIONAL)

The **MONARCH** high output ozone system is the only ozone purification system approved for installation in your **CALDERA** Spa. The **MONARCH** ozone system utilizes Corona Discharge (CD) technology to produce a higher concentration of ozone than is produced by competing ultraviolet light (UV) ozone systems.

The **MONARCH** high output ozone system greatly enhances the quality of the spa water when used to supplement the spa owner's regular water maintenance program. Contrary to some information circulated throughout the pool and spa industry regarding ozone systems, ozone **CANNOT** be used as a single-source sanitizer, water clarifier, anti-foamer, and mineral chelating agent. Watkins Manufacturing Corporation recommends following the **FROG** sanitizing system when using an ozone purification system to assure water sanitation and the highest quality of purified water.

CLEANING THE OZONE INJECTOR

On occasion, a mineral build up may clog the ozone injector, causing a lack of flow or low flow, of ozone bubbles. To prevent this, refer to the following instructions to clean the injector:

1. Disconnect power to the spa.
2. Access the equipment compartment.

WATER QUALITY AND MAINTENANCE

- Place 16 ounces of white vinegar into a container such as a cup or bucket. Place the container on the equipment compartment floor.
NOTE: White vinegar will not damage any of the spa components.
- Carefully loosen the long tubing to the bottom of the ozonator. **A liquid substance may be found inside the tubing. If a liquid substance is present, BE CERTAIN NOT TO COME INTO CONTACT WITH THE LIQUID .**

| | | |
|--|--|--|
|  WARNING | NITRIC ACID ACCUMULATES IN THE AIR LINES OF THE OZONATOR AND INJECTOR. NITRIC ACID WILL CAUSE SEVERE CHEMICAL BURNS IF DIRECT SKIN CONTACT IS MADE, SO ALWAYS WEAR PROTECTIVE GLOVES, GLASSES AND CLOTHING WHEN WORKING ON THE OZONATOR OR INJECTOR LINES. TO PREVENT INHALATION OR INGESTION OF THE NITRIC ACID, DO NOT BLOW OR INHALE WITH YOUR MOUTH TO ANY OF THE ADAPTERS, FITTINGS OR TUBING OF THE OZONATOR OR INJECTOR AIR LINES. |  WARNING |
|--|--|--|

- Place the end of the tubing into the vinegar, making certain that the end of the tubing sits at the bottom of the container.
- Reconnect power to the spa.
- Run the spa until all 16 ounces of the vinegar are gone. This should allow an ample flow of vinegar to be run through the injector and clear the blockage.
- Disconnect power to the spa.
- Remove the empty cup or bucket.
- Reinstall the tubing to the bottom of the ozonator.
- Close the equipment compartment door.
- Reconnect power to the spa.

The **MONARCH** ozone system is practically maintenance-free because it is located within the spa's equipment compartment. If bubbles are appearing at the spa's heater return, but the water is not as clear as usual, then the operation of the ozone generator should be checked your **CALDERA** Spa Dealer.

WARNING: Contact your **CALDERA** Spa Dealer if your spa requires troubleshooting beyond the scope of this manual. **MONARCH** ozone systems should only be serviced by a qualified technician.

WARRANTY NOTE: Cleaning of the ozone injector is not covered under the warranty. Refer to the Ozone section of this manual for ozone injector cleaning instructions.

DOS AND DON'TS

- DO add all chemicals slowly into or in front of the filter compartment with the jet pump operating for ten minutes.
- DO use special care if using baking soda to clean either the interior or exterior plastic surfaces.
- DO use only a granular form of bromine sanitizer.
- DON'T use swimming pool (muriatic) acid to lower pH.
- DON'T splash pH increaser additives on the siding.
- DON'T use Compressed Sanitizers.

The use of bromine sticks or tablets in floaters, which may become entrapped in a lounge or cooling seat (or sink to the spa floor), have been shown to cause discoloration of or surface distress to a spa's shell.

- DON'T use a floater type sanitization system as a low or no maintenance solution to your spa maintenance program.

Floating dispensers can become trapped in one area and cause an over-sanitization (or chemical burn) of that particular area.

If the dispenser setting is too high, the high concentration can discolor the spa shell and damage the underside of the cover.

Automatic floating dispensers have a tendency to either over-brominate or under-brominate as the rate of erosion varies greatly. Damage to the spa and cover can occur very quickly.

IMPORTANT: Watkins Manufacturing Corporation does not recommend the use of any floating chemical dispenser. Damage to the spa shell or components caused by a floating chemical dispenser is specifically not covered under the terms of the limited warranty.

- DON'T use a sanitizer which is not designed for spas.
- DON'T use household bleach (liquid sodium hypochlorite).
- DON'T broadcast or sprinkle the chemicals onto the water surface. This method may cause chemically-induced spa surface blistering (chemical abuse).

WATER QUALITY AND MAINTENANCE

COMMON WATER CHEMISTRY QUESTIONS

Question: Why is the use of a floater not recommended to sanitize my spa water?

Answer: Watkins Manufacturing Corporation does not recommend the use of a floater for three reasons:

1. The floater is unable to control the rate at which the sanitizer is dissolved into the water. When a floater is first placed in a spa, the sanitizer level can be extremely high. High sanitizer levels can chemically burn or discolor the spa's shell or the underside of the cover. Then, after a period of time, the sanitizer level dispensed by the floater will fall to near zero. A low sanitizer level will allow viruses, bacteria or algae to grow.
2. Floaters tend to stay in one area of the spa most of the time, causing this area to be exposed to extreme sanitizer levels.
3. The floater may allow pieces of the highly concentrated sanitizer to fall out and settle on the floor or seat of the spa shell. These pieces of sanitizer will chemically burn (blister) the spa shell. Although your spa shell is specifically designed to resist the effects of spa chemicals, no spa surface can withstand this type of highly concentrated chemical. Remember, chemical abuse is specifically not covered under the terms of the warranty.

Question: When I open my spa, I smell chlorine. How do I get rid of this smell?

Answer: There are two types of chlorine in your spa. The first is the Free Available Chlorine, which is the chlorine available to sanitize your spa. This Free Available Chlorine does not have an odor. The second is Chloramine, which is residue from chlorine already expended. Chloramines have a strong chlorine odor. The smell from Chloramines can be eliminated by "shocking" the water. If you smell chlorine in the water, your spa is reminding you to add a shock treatment.

Question: Why can't I fill my spa with soft water?

Answer: Soft water is essentially the same as regular water, except that most or all of the calcium has been replaced by sodium. Soft water may be corrosive to the heater and other components. Replacement of spa components damaged by soft water is extremely expensive.

Question: I am trying to reduce the number of chemicals to which my family is exposed. Do I really need to use so many chemicals and in such large amounts?

Answer: While over-exposure to any chemical can be unhealthy, many low levels of chemicals are effective and beneficial. In the case of spa water, the chemicals recommended in the **CALDERA** Spa Water Maintenance program are needed to protect the user from water-borne pathogens (disease-causing microbes) and to prevent corrosion of spa components.

Question: Why isn't water chemistry damage covered by the warranty?

Answer: The chemical levels and water quality of the water in the spa are under your direct control. With proper basic care, the spa will provide many years of hot water relaxation. If you are unsure about any chemical or its usage in the spa, contact your Authorized **CALDERA** Dealer or Watkins Manufacturing Corporation.

WATER QUALITY AND MAINTENANCE

SPA WATER MAINTENANCE TROUBLESHOOTING GUIDE

| PROBLEM | PROBABLE CAUSES | SOLUTIONS |
|---|--|---|
| Cloudy Water | <ul style="list-style-type: none"> • Dirty filters • Excessive oils / organic matter • Improper sanitization • Suspended particles / organic matter • Overused or old water | <ul style="list-style-type: none"> • Clean filters • Shock spa with sanitizer • Add sanitizer • Adjust pH and/or alkalinity to recommended range • Run jet pump(s) and clean filters • Drain and refill the spa |
| Water Odor | <ul style="list-style-type: none"> • Excessive organic in water • Improper sanitization • Low pH | <ul style="list-style-type: none"> • Shock spa with sanitizer • Add sanitizer • Adjust pH to recommended range |
| Chlorine Odor | <ul style="list-style-type: none"> • Chloramine level too high • Low pH | <ul style="list-style-type: none"> • Shock spa with sanitizer • Adjust pH to recommended range |
| Musty Odor | <ul style="list-style-type: none"> • Bacteria or algae growth | <ul style="list-style-type: none"> • Shock spa with sanitizer – if problem is visible or persistent, drain, clean and refill the spa |
| Organic buildup / scum ring around spa | <ul style="list-style-type: none"> • Buildup of oils and dirt | <ul style="list-style-type: none"> • Wipe off scum with clean rag – if severe, drain the spa, use a spa surface and tile cleaner to remove the scum and refill the spa |
| Algae Growth | <ul style="list-style-type: none"> • High pH • Low sanitizer level | <ul style="list-style-type: none"> • Shock spa with sanitizer and adjust pH • Shock spa with sanitizer and maintain sanitizer level |
| Eye Irritation | <ul style="list-style-type: none"> • Low pH • Low sanitizer level | <ul style="list-style-type: none"> • Adjust pH • Shock spa with sanitizer and maintain sanitizer level |
| Skin Irritation / Rash | <ul style="list-style-type: none"> • Unsanitary water • Free chlorine level above 5 ppm | <ul style="list-style-type: none"> • Shock spa with sanitizer and maintain sanitizer level • Allow free chlorine level to drop below 5 ppm before spa use |
| Stains | <ul style="list-style-type: none"> • Total alkalinity and/or pH too low • High iron or copper in source water | <ul style="list-style-type: none"> • Adjust total alkalinity and/or pH • Use a metal deposit inhibitor |
| Scale | <ul style="list-style-type: none"> • High calcium content in water – total alkalinity and pH too high | <ul style="list-style-type: none"> • Adjust total alkalinity and pH – if scale requires removal, drain the spa, scrub off the scale, refill the spa and balance the water |

SERVICE

MISCELLANEOUS SERVICE INFORMATION

The control and high limit thermostats are equipped with electronic sensors that are connected to the spa's plumbing. Never cut, or kink the wires that connect the sensors to the thermostats within the control box.

The jet pump is equipped with a thermal overload cutoff switch that is designed to protect the pump from overheating. If the pump shuts itself off in an older spa, it could indicate failure of the pump motor bearings. If the pump shuts itself off in a new spa, it is usually the result of one or a combination of the following factors:

- **High Temperature:** All **CALDERA** spa models are equipped with a jet pump shroud that vents the heat generated by the pump motor to the outside of the equipment compartment. If the vent is blocked by masonry, grass, or debris, overheating of the jet pump may occur. Once the pump motor has cooled sufficiently and any blockage has been removed from the vent opening, the jet pump can be restarted.
- **Improper Wiring:** If the spa is connected with an extension cord, and/or the house wiring is undersized, the pump may starve for voltage and therefore may draw more amperage and generate excessive heat.
- If the pump is shutting down due to excessive heat, make sure the equipment compartment has adequate ventilation. The air gap at the bottom must not be blocked. If your jet pump continues to shut off after short periods of use, contact a qualified service technician.

ACTS INVALIDATING WARRANTY

The limited warranty is void if the **CALDERA** spa has been improperly installed, subjected to alteration, misuse, or abuse, or if any repairs on the spa are attempted by anyone other than an authorized representative of Watkins Manufacturing Corporation. Alteration shall include any component or plumbing change, electrical conversion, or the addition of any non-approved sanitation or water purification device or heating system which contributes to component or unit failure or unsafe operating system. Misuse and abuse shall include any operation of the spa other than in accordance with Watkins Manufacturing Corporation printed instructions, or use of the spa in an application for which it is not designed; specifically: use of the spa in a non-residential application; damage caused by operation* of the spa at water temperatures outside the range of 35°F and 120 °F; damage caused by a dirty, clogged or calcified filter cartridge; damage to the spa surface caused by the use of tri-chloro chlorine, BCDMH, misuse of chemical tablets in a floater, acid, or any other spa chemicals or spa surface cleaners which are not recommended by Watkins Manufacturing Corporation; damage caused by allowing undissolved spa sanitizing chemicals to lie on the spa surface (no spa surface material can withstand this kind of abuse); damage to components or spa surface caused by improper water chemistry maintenance; and damage to the spa surface caused by leaving the spa uncovered while empty of water and in direct exposure to sunlight (this may cause solar heating distress in warm weather regions). These are considered abuses and may invalidate this warranty.

*Operation of the spa does not mean "use" of the spa. Watkins Manufacturing Corporation does not recommend using the spa if the water temperature is above or below the spa's control panel temperature range.

DISCLAIMERS

Watkins Manufacturing Corporation shall not be liable for loss of use of the **CALDERA** spa, or other incidental, consequential, special, indirect, or punitive costs, expenses or damages, which may include but are not limited to the removal of a permanent deck or other custom fixture, or the necessity for crane removal. Any implied warranty shall have a duration equal to the duration of the applicable limited warranty stated above. Some states do not allow limitations on how long an implied warranty lasts. Under no circumstances shall Watkins Manufacturing Corporation or any of its representatives be held liable for injury to any person or damage to any property, however arising.

Some states do not allow the exclusion or limitation of incidental or consequential damages, so the above limitations may not apply to you.

WATKINS CUSTOMER SERVICE

If you have any questions about any aspect of your **CALDERA** spa set-up, operation, or maintenance that have not been answered by this manual, consult your **CALDERA** dealer.

Watkins Manufacturing Corporation can be reached at: 800-669-1881 (Extension 8432), Monday through Friday, 8 am to 5-pm Pacific Standard Time (PST), or e-mail custsvc@watkinsmfg.com

SPA TROUBLESHOOTING

If your spa doesn't seem to be working the way you believe it should, please review the "start-up" and "operation" instructions in this manual. If this doesn't help you correct the problem, follow the appropriate instructions below. If the problem is still not resolved, call your **CALDERA** dealer.

| GENERAL OPERATION TROUBLESHOOTING GUIDE | | |
|---|--|--|
| PROBLEM | PROBABLE CAUSES | SOLUTIONS |
| Entire spa is inoperative | <ul style="list-style-type: none"> Power failure GFCI tripped Heater high limited thermostat tripped Spa Lock activated | <ul style="list-style-type: none"> Check power source Reset GFCI; call for service if it will not reset. Disconnect power for at least thirty seconds to reset heater high limit. If it will not reset, check for clogged filters. If tripping continues, call for service. Deactivate Spa Lock |
| Jets weak or surging | <ul style="list-style-type: none"> Spa water level too low Filter clogged Air valves are closed | <ul style="list-style-type: none"> Add water Clean filter Open air valves |
| Light inoperative | <ul style="list-style-type: none"> Spa Lock activated Light assembly is faulty | <ul style="list-style-type: none"> Deactivate Spa Lock Call for service |
| Both Power and Ready Indicators Blinking | <ul style="list-style-type: none"> Dirty filter Low water level Pressure switch problem Temperature sensor problem | <ul style="list-style-type: none"> Clean filter See Start Up section in Owner's Manual Disconnect power for at least thirty seconds. If flashing continues after power up, call for service |
| Power Indicator Blinking with four lines in display area | <ul style="list-style-type: none"> Heater high limit thermostat tripped | <ul style="list-style-type: none"> Disconnect power for at least thirty seconds to reset heater high limit. If it will not reset, check for clogged filter. If tripping continues, call for service |
| Ready Indicator Blinking | <ul style="list-style-type: none"> Temperature sensor problem | <ul style="list-style-type: none"> Disconnect power for at least thirty seconds. If blinking continues after power up, call for service |
| Spa not heating properly | <ul style="list-style-type: none"> Temperature set too low Spa cover improperly positioned Dirty filter Summer Timer on | <ul style="list-style-type: none"> Set control panel to a higher temperature. Align spa cover Clean filter Turn summer timer mode to off position |
| Pump motor will not function | <ul style="list-style-type: none"> Motor overload condition Control switch failure if jet symbol does not come on | <ul style="list-style-type: none"> Let cool for one hour. Motor overload will reset automatically. If problem persists, contact your CALDERA dealer Disconnect spa and contact your CALDERA dealer |
| Noisy pump or motor | <ul style="list-style-type: none"> Low water level | <ul style="list-style-type: none"> Add water to normal level (1 inch above highest jet) |
| Pump motor runs, but low or no water/jet pressure | <ul style="list-style-type: none"> Air control valve closed or blocked Low water level Dirty filter cartridge Jet blocked Clogged suction or skimmer basket | <ul style="list-style-type: none"> Open or clean air valve Add water to normal level (1 inch above highest jet) Clean filter cartridge Remove jet face eyeball and clean orifice Clean suction cover or skimmer basket |
| Diverter valves are difficult to turn | <ul style="list-style-type: none"> Sand or grit inside valves | <ul style="list-style-type: none"> Clean and lubricate valve per diverter valve maintenance instructions |
| After filling or refilling the spa: a jet pump is operating, but water is not flowing from any of its jets. | <ul style="list-style-type: none"> Pump is not properly primed. | <ul style="list-style-type: none"> Turn off power to the spa at the breaker and remove the equipment compartment door (see the "Draining Your Spa" section for illustration). Loosen the union on the top of the pump(s) (see the "Winterizing Your Spa" section for illustration) to allow the air to escape, and then hand-tighten the union(s). Turn power back on, activate the pump, and check to make sure the union is tight enough to keep it from leaking. Replace the equipment doors. <p>OR: Remove and reinstall the FROG cap.</p> |

Paradise Series

Limited Warranty

Watkins Manufacturing Corporation (“Watkins”) warrants to the original consumer purchaser (“you”) the following about your new Paradise Series spa, when purchased from an authorized dealer/service provider (“dealer”).

10 YEAR NO LEAK SHELL WARRANTY

Watkins warrants against water loss due to defects in the Paradise series spa shell for ten years.

7 YEAR SHELL SURFACE WARRANTY

Watkins warrants the acrylic surface material of the Paradise Series spas to be free from defects in materials and workmanship for seven years.

5 YEAR NO LEAK PLUMBING WARRANTY

Watkins warrants the Paradise Series spas against leaks caused by defects in manufacturing and workmanship for five years. This warranty specifically covers leaks from the wall fittings, jet fittings, internal plumbing, internal glue joints, drains, hoses, and all bonded parts.

5 YEAR COMPONENT WARRANTY

Watkins warrants the electrical components, pump(s), and other Paradise Series spa components against defects in materials and workmanship for five years. Some parts, most of which can be changed out without the use of tools, such as filter cartridges, filter lid, spa pillows, and cover locks are not included in this warranty, but are warranted to be free from defects in materials and workmanship at the time of delivery. Spa covers and other spa accessories are specifically excluded from this warranty, although they may be covered under other warranties. Please check with your Caldera dealer for details.

5 YEAR ENERGYPRO® HEATER WARRANTY

Watkins unconditionally warrants the EnergyPro heater to be free from defects in materials and workmanship for five years. This warranty defines unconditional, with the exclusion of commercial or industrial use, and improper installation, as warranty coverage without exception provided that the component has failed to operate properly within the spa’s system.

3 YEAR ECOTECH® CABINET WARRANTY

Watkins warrants the EcoTech simulated wood cabinet to be free from defects in materials and workmanship for three years. This warranty specifically covers the EcoTech cabinet’s structural integrity (exclusive of surface stain), including the material and assembly.

The EcoTech cabinet’s cosmetic finish is warranted to be free from defects in materials and workmanship at the time of initial delivery. Fading and weathering of the surface may naturally occur over time and are not considered defects. To restore the EcoTech cabinet’s appearance, refer to the spa Owner’s Manual for proper care and maintenance instructions.

2 YEAR LED LIGHTING SYSTEM WARRANTY

Watkins warrants the factory-installed LED light assemblies which consist of all lights within the spa to be free from defects in materials and workmanship for two years.

1 YEAR FROG® AND SPEAKERS WARRANTY

Watkins warrants the factory-installed FROG water care system, and the audio speakers to be free from defects in materials and workmanship for one year.

The following applies to all of the warranties listed:

EXTENT OF WARRANTY

This warranty extends only to the original consumer purchaser of the Caldera spa when purchased and originally installed within the boundaries of the United States. This warranty begins on your delivery date of the spa, but in no event later than one year from the date of purchase.

This warranty terminates upon any transfer of ownership, or if the spa is installed or relocated outside the boundaries of the United States by the original consumer purchaser prior to the expiration of the warranty period.

WARRANTY PERFORMANCE

To make a claim under this warranty, contact your dealer. In the event you are unable to obtain service from the dealer, please contact Watkins Manufacturing Corporation at 1280 Park Center Drive, Vista, California, 92081, Attn: Customer Service Department (800) 669-1881 or via e-mail, custsvc@watkinsmfg.com. You must give Watkins and/or your dealer written notice of any warranty claim, along with a copy of your original purchase receipt indicating the date of the purchase, within ten (10) days of the time you discover the claim. Watkins reserves the right to inspect the malfunction or defect on location.

Watkins or its Authorized Service Agent will repair any defects covered by this warranty. Except as described herein, you will not be charged for parts, labor or the freight costs for parts necessary to repair the spa for defects covered by this warranty. In some cases, the servicing dealer may charge you a reasonable repairperson travel/service charge that is not covered by this warranty. Please contact the dealer for information regarding any such charges.

LIMITATIONS

Except as described above, this warranty does not cover defects or damage due to normal wear and tear, improper installation, alteration without Watkins’ prior written consent, accident, acts of God, misuse, abuse, commercial or industrial use, use of an accessory not approved by Watkins, failure to follow Watkins’ Pre-Delivery Instructions or Owner’s Manual, or repairs made or attempted by anyone other than an authorized representative of Watkins. Alteration includes, but is not limited to, any component or plumbing change, or electrical conversion. Visit www.calderaspas.com or contact your dealer for a list of manufacturer approved accessories.

DISCLAIMERS

TO THE EXTENT PERMITTED BY LAW, WATKINS SHALL NOT BE LIABLE FOR LOSS OF USE OF THE SPA OR OTHER INCIDENTAL OR CONSEQUENTIAL COSTS, EXPENSES, OR DAMAGES, INCLUDING BUT NOT LIMITED TO THE REMOVAL OF ANY DECK OR CUSTOM FIXTURE OR ANY COST TO REMOVE OR REINSTALL THE SPA, IF NEEDED. Some states do not allow the exclusion or limitation of incidental or consequential damages, so the above limitations may not apply to you. **ANY IMPLIED WARRANTIES, INCLUDING THE IMPLIED WARRANTIES OF MERCHANTABILITY AND FITNESS FOR A PARTICULAR PURPOSE, ARE LIMITED TO THE DURATION OF THE APPLICABLE WARRANTY STATED ABOVE.** Some states do not allow limitations on how long an implied warranty may last, so the above limitations may not apply to you.

LEGAL REMEDIES

This warranty gives you specific legal rights, and you may have other rights which vary from state to state.



PARADISE SERIES SPA SPECIFICATIONS

This manual contains installation, operating, maintenance and service information for the following CALDERA Spa models:

| | Footprint dimensions | Height | Effective filter area | Heater (Watts) | Water capacity | Dry weight | Filled weight* | Dead weight | Electrical Requirements |
|-------------------|----------------------|--------|-----------------------|----------------|----------------|------------|----------------|--------------------------|--|
| MAKENA | 7'5" x 7'5" | 36" | 75 square feet | 4,300 | 395 gallons | 1,020 lbs. | 5,364 lbs. | 120 lbs. per square foot | 230 volt, 30 or 50 amp Single phase GFCI protected circuit |
| SALINA | 7'5" x 7'5" | 36" | 75 square feet | 4,300 | 420 gallons | 1,006 lbs. | 5,734 lbs. | 125 lbs. per square foot | 230 volt, 30 or 50 amp Single phase GFCI protected circuit |
| MARTINIQUE | 7'5" x 6'4" | 34" | 50 square feet | 4,300 | 320 gallons | 928 lbs. | 4,472 lbs. | 115 lbs. per square foot | 230 volt, 30 or 50 amp Single phase GFCI protected circuit |
| KAUAI | 7'0" x 5'5" | 29" | 50 square feet | 4,300 | 220 gallons | 738 lbs. | 3,098 lbs. | 100 lbs. per square foot | 230 volt, 30 or 50 amp Single phase GFCI protected circuit |

CAUTION: Watkins Manufacturing Corporation suggests a structural engineer or contractor be consulted before the spa is placed on an elevated deck.

* NOTE: The "Filled weight" and "Dead weight" of the spa includes the weight of the occupants (assuming an average occupant weight of 175 lbs). For 30 amp conversion contact your local dealer.



©2013 Watkins Manufacturing Corporation. Caldera Spas, Salina, Makena, Martinique, Kauai, Monarch, Vanishing Act, Aquatic Melodies, Acquarella, AdaptaFlo, Advent, EnergyPro, EcstaSeat, Euro-Pulse, VersaSsage, UltraMassage, LumbarSsage, Sole Soothers, and Euphoria are trademarks of Watkins Manufacturing Corporation. BaquaSpa is a trademark of Arch UK Biocides Limited, Inc. FROG is a registered trademark of King Technologies. Soft Soak is a registered trademark of BioLab, Inc. iPod is a trademark of Apple Inc.



Watkins Manufacturing Corporation
Vista, California
USA

calderaspas.com