



Utopia[®] Series.

2024 OWNER'S MANUAL



WELCOME



Watkins Wellness® congratulates you on your decision to enjoy the finest spa available. Welcome to the growing family of Caldera® spa owners.

OWNER'S MANUAL

This Owner's Manual will acquaint you with the operation and general maintenance of your new spa. We suggest that you take some time to carefully review all sections. Please keep this manual available for reference.

If you have questions about any aspect of your spa's set-up, operation or maintenance, contact your authorized **CALDERA** dealership. They are trained professionals who are familiar with the product as well as new spa ownership concerns. Their expertise will facilitate the enjoyment of your new **CALDERA** spa.

The serial number/identification label is located within the equipment compartment of your **CALDERA** spa. The serial number should also be documented on the delivery receipt from your dealer.

IMPORTANT: WATKINS WELLNESS reserves the right to change specifications, or design, without notification and without incurring any obligation.

DATE PURCHASED: _____

DATE INSTALLED: _____

DEALER: _____

ADDRESS: _____

TELEPHONE: _____

SPA MODEL/SERIAL NUMBER: _____

COVER SERIAL NUMBER: _____



MODEL: TAHITIAN
SERIES: UTOPIA
SERIAL: TAB24D119XXXX
RATINGS: 240V, 60Hz, 40A



LISTED SELF CONTAINED SPA
1280 Park Center Dr., Vista, CA 92081
Watkins Manufacturing Corp.



NOTE: This is an example. Your spa's label will contain different information. Peel off top sticker and place here.

In most cities and counties, permits will be required for the installation of electrical circuits or the construction of exterior surfaces (decks and gazebos). In addition, some communities have adopted residential barrier codes which may require fencing and/or self-closing gates on the property to prevent unsupervised access to a pool (or spa) by children under 5 years of age. Your **CALDERA** spa is equipped with a locking cover that meets the ASTM F1346-91 Standard for Safety Covers, and as a result, is usually exempt from most barrier requirements. As a general practice, your local Building Department will inform you of any applicable barrier requirements at the time a permit is obtained for the installation of an electrical circuit. Your **CALDERA** dealer can provide information on which permits may be required.

TABLE OF CONTENTS

SAFETY INFORMATION

IMPORTANT SAFETY INSTRUCTIONS.....	1
IMPORTANT SPA INSTRUCTIONS.....	3

GETTING STARTED

MAIN SPA FEATURES.....	4
HYDRO JETS.....	5
DIVERTER VALVES.....	5
ACQUARELLA® WATERFALL VALVE.....	6
AIR CONTROLS.....	6
ATLAS® NECK JET VALVE.....	6
CALDERA LOGO LIGHT.....	6
QUICK START-UP INSTRUCTIONS.....	6

WATER QUALITY AND MAINTENANCE

BASIC INFORMATION.....	8
CHEMICAL SAFETY.....	8
HOW TO ADD CHEMICALS TO THE WATER.....	8
FUNDAMENTALS OF WATER MAINTENANCE.....	9
THE CALDERA SPA WATER MAINTENANCE PROGRAM.....	10
VANISHING ACT™ INSTRUCTIONS.....	11
VACATION WATER CARE INSTRUCTIONS.....	12
GLOSSARY.....	13

OPERATING INSTRUCTIONS

MAIN CONTROL PANEL.....	14
HOME SCREEN.....	14
MEMORY SCREEN.....	15
CLEAN CYCLE SCREEN.....	15
VANISHING ACT.....	15
SETTINGS SCREENS.....	15
TEMPERATURE CONTROL.....	17
JETS CONTROL SCREEN.....	17
FRESHWATER® IQ SMART MONITORING SYSTEM ..	18
MUSIC SYSTEM SCREEN (OPTIONAL).....	18
LIGHTS CONTROL SCREEN.....	19
AUXILIARY PANEL.....	20
CANTABRIA ® ULTRAMASSEUSE CONTROL PANEL.....	20

JET MENU

CANTABRIA JET SYSTEM MENU.....	22
GENEVA® JET SYSTEM MENU.....	23
NIAGARA® JET SYSTEM MENU.....	24
TAHITIAN®.....	25
FLORENCE®.....	26
RAVELLO™.....	27

SPA CARE AND MAINTENANCE

FILTER MAINTENANCE.....	28
FILTER CARTRIDGE REMOVAL AND CLEANING INSTRUCTIONS.....	28
DIVERTER VALVE MAINTENANCE.....	28
VERSASSAGE JET MAINTENANCE.....	28
DRAINING YOUR SPA.....	29
PREVENTION OF FREEZING.....	29
WINTERIZING YOUR SPA.....	29
CARE OF THE SPA PILLOWS.....	30
CARE OF THE EXTERIOR.....	30
CARE OF THE SPA COVER.....	30

ELECTRICAL REQUIREMENT

230 VOLT PERMANENTLY CONNECTED.....	31
EQUIPMENT COMPARTMENT.....	31

SERVICE INFORMATION

GENERAL INFORMATION.....	34
GFCI AND HIGH LIMIT THERMOSTAT.....	34
HEATER AND INTEGRATED PRESSURE SWITCH.....	34
CIRCULATION PUMP AND CIRCULATION PUMP THERMAL CUT-OFF.....	34
MISCELLANEOUS SERVICE INFORMATION.....	34
ACTS INVALIDATING WARRANTY.....	35
DISCLAIMERS.....	35
WATKINS CUSTOMER SERVICE.....	35
TROUBLESHOOTING.....	35
DOOR PANEL REMOVAL.....	37

SAFETY INFORMATION

IMPORTANT SAFETY INSTRUCTIONS

(READ AND FOLLOW ALL INSTRUCTIONS)

AVOIDING THE RISK TO CHILDREN

DANGER - RISK OF CHILD DROWNING

Extreme caution must be exercised to prevent unauthorized access by children. To avoid accidents, ensure that children cannot use a spa unless they are supervised at all times.

WARNING

To reduce the risk of injury, do not permit children to use this spa unless they are closely supervised at all times.

- To reduce the risk of injury, lower water temperatures are recommended for young children. Children are especially sensitive to hot water.
- Extreme caution must be exercised to prevent unauthorized access by children. To avoid accidents, ensure that children cannot use a spa unless they are supervised at all times.

DO:

- Make sure you always lock the child resistant locks after using the spa for your children's safety. Every **CALDERA** spa is equipped with a locking cover that meets the ASTM F1346-91 Standard for Safety Covers.
- Test the water temperature with your hand before allowing children to enter the spa to be sure that it's comfortable. Children are especially sensitive to hot water.
- Remind children that wet surfaces can be very slippery. Make sure that children are careful when entering or exiting the spa.

DON'T:

- Allow children to climb onto the spa cover.
- Allow children to have unsupervised access to the spa.

AVOIDING THE RISK OF ELECTROCUTION

DANGER - RISK OF ELECTROCUTION

- Connect only to a grounded source.
- Do not bury the power cord. A buried power cord may result in death, or serious personal injury due to electrocution if direct burial-type cable is not used, or if improper digging occurs.
- A ground terminal (pressure wire connector) is provided on the control box inside the unit to permit connection of a minimum No. 8 AWG solid copper bonding conductor between this point and any metal equipment, metal water pipe, metal enclosures of electrical equipment, or conduit within 5 feet (1.5 m) of the unit as needed to comply with local requirements.

- Do not operate the audio main controls while inside the spa (if spa is equipped with an audio component).
- Do not connect any auxiliary components (for example, cable additional speakers, headphones, additional audio components) to the audio system unless approved by **WATKINS WELLNESS**.
- Do not self service audio component by opening or removing spa door panel as this may expose dangerous voltage or other risk of injury. Refer all servicing to qualified service personnel.
- Do not attach an external antennae to a spa audio system unless installed by a licensed electrician in accordance with Article 810 of the National Electric Code, ANSI/NFPA 70.

WARNING

- To reduce the risk of electrical shock, replace a damaged cord immediately. Failure to do so may result in death or serious personal injury due to electrocution.
- Your spa is provided with a Ground Fault Circuit Interrupter (GFCI) for user and equipment protection. To ensure proper operation of this important safety device, test according to the following instructions per electrical configuration.
- **230 volt, permanently installed or converted models:**
 - A ground terminal is provided on the terminal block (TB-1, system ground terminal) located inside the control box. To reduce the risk of electric shock, connect this terminal to the grounding terminal of your electrical service or supply panel with a continuous green, insulated copper wire. The wire must be equivalent in size to the circuit conductors supplying the equipment. In addition, a bonding terminal (pressure wire connector) is provided on the outside of the control box for bonding to local ground points. To reduce the risk of electric shock, this connector should be bonded with a No. 8 AWG solid copper wire to any metal ladders, water pipes, or other metal within 5 feet (1.5 m) of the spa to comply with local requirements. The means of disconnection must be readily accessible, but must be installed at least 5 feet (1.5 m) from the spa.
 - Your spa is provided with a suitably rated circuit breaker to open all ungrounded supply conductors.
 - Your spa uses ground fault circuit interrupters in the electrical subpanel. Before each use of the spa and with the unit operating, push the TEST button on each breaker. The switch should click over to the "Trip" position. Wait 30 seconds and reset each GFCI breaker by switching it completely off and then completely on. The switch should then stay on. If either of the interrupters does not perform in this manner, it is an indication of an electrical malfunction and the possibility of an electric shock. Disconnect the power until the fault has been identified and corrected.

DANGER - RISK OF ELECTRICAL SHOCK

- Install at least 5 feet (1.5 m) from all metal surfaces. A spa may be installed within 5 feet (1.5 m) of a metal surface if each metal surface is permanently connected by a minimum No. 8 AWG (8.4 mm²) solid copper conductor attached to the wire ground connector on the terminal box that is provided for this purpose if in accordance with National Electrical Code ANSI/NMFA70-1993.

- Do not permit any electrical appliances, such as a light, telephone, radio, or television within 5 feet (1.5 m) of a spa. Failure to maintain a safe distance may result in death, or serious personal injury due to electrocution, if the appliance should fall into the spa.
- Install your spa in such a way that drainage is away from the electrical compartment and from all electrical components.

DO:

- Be sure your spa is connected to the power supply correctly - use a licensed electrical contractor.
- Disconnect the spa from the power supply before draining the spa or servicing the electrical components.
- Test the Ground Fault Circuit Interrupter(s) before each use.
- Replace audio components only with identical components (if your spa is equipped with an audio component).

DON'T:

- Use the spa with the equipment compartment door removed.
- Place electrical appliances within 5 feet (1.5m) of the spa.
- Use an extension cord to connect the spa to its power source. The cord may not be properly grounded and the connection is a shock hazard. An extension cord may cause a voltage drop, which will cause overheating of the jet pump motor and motor damage.
- Attempt to open the electrical control box. There are no user serviceable parts inside.

RISKS TO AVOID

DANGER - RISK OF INJURY

- To reduce the risk of injury to persons, DO NOT remove suction fittings (filter standpipe) located in the filter compartment.
- The suction fittings in the spa are sized to match the specific water flow created by the pump. Never replace a suction fitting with one rated less than the flow rate marked on the original suction fitting.
- There is a danger of slipping and falling. Remember that wet surfaces can be very slippery. Take care when entering or exiting the spa.
- Never operate spa if the suction fittings are broken or missing.
- People with infectious diseases should not use the spa.
- Keep any loose articles of clothing, long hair, or hanging jewelry away from rotating jets or other moving components.

INCREASED SIDE EFFECTS OF MEDICATION

- The use of drugs, alcohol may cause unconsciousness with the possibility of drowning.
- Persons using medications should consult a physician before using a spa; some medication may cause a user to become drowsy, while other medication may affect heart rate, blood pressure, and circulation.
- Persons taking medications which induce drowsiness, such as tranquilizers, antihistamines, or anticoagulants should not use the spa.

HEALTH PROBLEMS AFFECTED BY SPA USE

- Pregnant women should consult a physician before using spa.
- Persons suffering from obesity, or with a medical history of heart disease, low or high blood pressure, circulatory system problems, or diabetes should consult a physician before using spa.

UNCLEAN WATER

- Keep the water clean and sanitized with correct chemical care. The recommended levels for your CALDERA spa are:

Free Available Chlorine: 1-5ppm	Total Alkalinity: 40-120ppm
Water pH: 7.2-7.8	Calcium Hardness: Standard 75-150ppm Salt System 25-75ppm

- Refer to Water Quality and Maintenance section for complete instructions.

IMPORTANT: Turn on the jet pump for a least ten minutes after adding ANY spa water chemicals into the filter compartment.

Clean the filter cartridge monthly to remove debris and mineral buildup which may affect the performance of the hydromassage jets, limit the flow, or trip the high limit thermostat, which will turn off the entire spa.

AVOIDING THE RISK OF HYPERTHERMIA

Prolonged immersion in hot water can result in HYPERTHERMIA, a dangerous condition which occurs when the internal temperature of the body reaches a level above normal 98.6°F (37°C). The symptoms of hyperthermia include unawareness of impending hazard, failure to perceive heat, failure to recognize the need to exit the spa, physical inability to exit the spa, fetal damage in pregnant women, and unconsciousness resulting in a danger of drowning.

WARNING

The use of alcohol, drugs, or medication can greatly increase the risk of fatal hyperthermia in hot tubs and spas.

TO REDUCE THE RISK OF INJURY

- The water in the spa should never exceed 104°F (40°C). Water temperatures between 100°F and 104°F (36°C and 40°C) are considered safe for a healthy adult. Lower water temperatures are recommended for extended use (exceeding ten minutes) and for young children. Extended use can cause hyperthermia.
- Pregnant or possibly pregnant women should limit spa water temperatures to 100°F (36°C). Failure to do so may result in permanent injury to your baby.
- Do not use spa immediately following strenuous exercise.

AVOIDING THE RISK OF SKIN BURNS

- To reduce the risk of injury, before entering a spa the user should measure the water temperature with an accurate thermometer.
- Test the water with your hand before entering the spa to be sure it's comfortable.

SAFETY SIGN

Each **CALDERA** spa is shipped with a SAFETY SIGN in the owner's package. The sign, which is required as a condition of Product Listing, should be permanently installed where it is visible to the users of the spa. To obtain additional SAFETY SIGNS, contact your **CALDERA** dealer and request Part #70798.

IMPORTANT SPA INSTRUCTIONS

The following contains important spa information, and we strongly encourage you to read and apply them.

DO:

- Use and lock the cover when the spa is not in use, whether it is empty or full.
- Follow the Spa Care and Maintenance recommendations stated in this manual.
- Use only approved accessories and recommended spa chemicals and cleaners.

DON'T:

- Leave the **CALDERA** spa exposed to the sun without water or the cover in place. Exposure to direct sunlight can cause solar distress of the shell material.
- Roll or slide the spa on its side. This will damage the siding.
- Lift or drag the cover by using the cover lock straps; always lift or carry the cover by using the handles.
- Attempt to open the electrical control box. There are no user serviceable parts inside. Opening of the control box by the spa owner will void the warranty. If you have an operational problem, carefully go through the steps outlined in the Troubleshooting section. If you are not able to resolve the problem, contact your authorized **CALDERA** dealer. Many problems can easily be diagnosed over the telephone by an Authorized Service Technician.

SPA SHELL

Your **CALDERA** spa has an acrylic shell. Stains and dirt generally will not adhere to your spa's surface. A soft cloth should easily remove most dirt. Most household chemicals are harmful to your spa's shell (see below for detailed information on cleaning agents). Always rinse off any spa shell cleaning agent with fresh water.

IMPORTANT:

1. The following products are the **ONLY** approved cleaning agents for your **CALDERA** spa shell: plain water, or Soft Scrub®. The use of alcohol or any other household cleaner other than those listed to clean the spa shell surface is **NOT** recommended. **DO NOT** use any cleaning products containing abrasives or solvents since they may damage the shell surface, specifically: Simple Green®, Windex® or Spa Mitt. **NEVER USE HARSH CHEMICALS!** Damage to the shell by use of harsh chemicals is not covered under the warranty. Always rinse off any spa shell cleaning agent with fresh water.
2. Iron and copper in the water can stain the spa shell if allowed to go unchecked. Ask your **CALDERA** dealer about a Stain and Scale Inhibitor to use if your spa has a high concentration of dissolved minerals. (**WATKINS WELLNESS** recommends Stain & Scale Defense.)
3. Keep all cleaners out of the reach of children and use care when applying.

SAVE THESE INSTRUCTIONS

GETTING STARTED

MAIN SPA FEATURES

(Your spa may look different)



1) The **Main control panel** provides a quick visual check of the spa's status and allows the user to set different functions of the spa.



2) The **Auxiliary control panel** allows the user to activate the jets, air jets and lights across from the main control panel.



3) The **Diverter system** lets you divert water to different combinations of jets simply by turning the lever.



4) The **Air Valve lever** lets you dial in the ideal amount of air for your jets.



5) The **Water Feature Lever** adjusts the amount of water that flows from the water feature.



6) The **ATLAS Neck Jet Lever** adjusts the amount of water that flows through the Neck Jets.



7) The **AdaptaSsage**® jet provides a rotating massage pattern.



8) The **AdaptaFlo**® jet allow you to redirect the jet stream by changing the position of the nozzle.



9) The **Euro Directional** jets, with eyeball nozzles, deliver a direct, more focused massage.



10) The **Euro-Pulse**® jets feature a special insert that creates a soft, pulsating, rotary massage.



11) The **VersaSsage**® jet may be adjusted to provide either a stationary, direct stream or, by positioning the nozzle to one side or the other, a rotating jet stream.



12) The **OrbiSsage**® jet provides a unique, pulsating massage.



13) The **Euphoria**® jet provides a deep, powerful, penetrating massage to your thighs, knees, calves, and feet.



14) **FRESHWATER** Salt System housing cap.

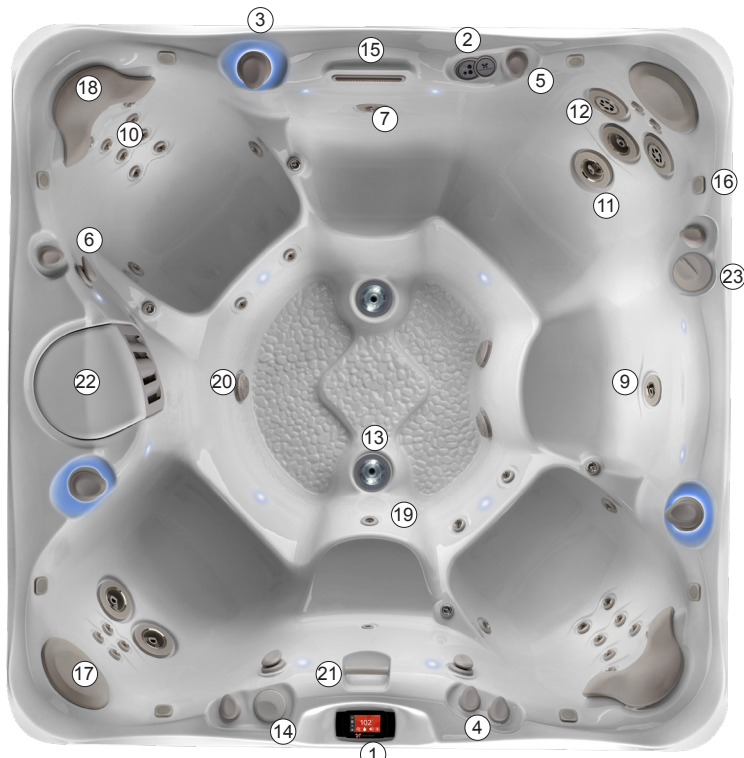

ADDITIONAL SPA FEATURES

15) **ACQUARELLA** water feature

16) Speaker (Optional)

17) Pillow

18) **ATLAS** Neck Jet Pillow

19) Ozone Jet/Heater Return

20) Suction Screen

21) Grab Rail

22) Filter Compartment Lid

23) **FRESHWATER** Smart Monitoring System housing cap

HYDRO JETS

ADAPTAFLO Jets - These jets allow you to redirect the jet stream by changing the position of the nozzle.

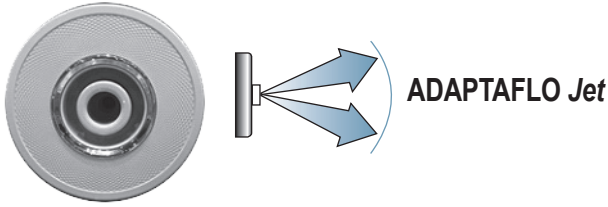

ADAPTASSAGE Jets - These jets provide a rotating massage pattern.

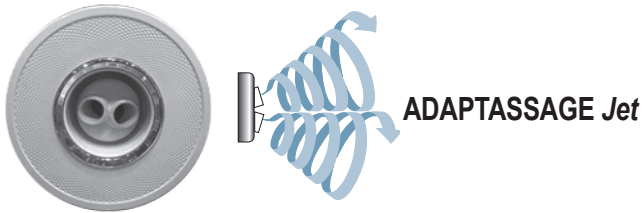

The face plates in the **ADAPTAFLO** jets and the **ADAPTASSAGE** jets are interchangeable. To remove a **ADAPTASSAGE** face plate, turn it counter-clockwise until it stops turning. Turn the face once more until you hear a clicking noise, push it in, and then pull it straight off. Install the face plate by snapping it into place. Additional **ADAPTASSAGE** dual-port nozzles are available from your **CALDERA** dealer.

Both the **ADAPTAFLO** and **ADAPTASSAGE** jets allow you to regulate the force of the massage. Rotate the fascia ring to reduce or increase the force. Notice that turning off the flow to some jets increases the flow to the other jets. To avoid damage to your spa's plumbing and components, do not turn off more than half of these jets at the same time.

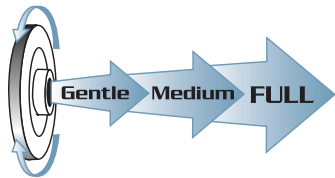

Euro Directional - The Euro Directional jets, with eyeball nozzles, deliver a direct, more focused massage.



EURO-PULSE Jets - The **EURO-PULSE** jets feature a special insert that creates a soft, pulsating, rotary massage.

NOTE: Please do not attempt to rotate the jet face on either the Euro Directional, or **EURO-PULSE** as these jets do not regulate the force of the massage.



VERSASSAGE Jets - These jets may be adjusted to provide either a stationary, direct stream or, by positioning the nozzle to one side or the other, a rotating jet stream.

The **VERSASSAGE** jets allow you to regulate the force of the massage. Rotate the fascia ring counter-clockwise to reduce the force, or clockwise to increase the force. Notice that turning off the flow to some jets increases the flow to the other jets. To avoid damage to your spa's plumbing and components, do not turn off more than half of these jets at the same time. For cleaning instructions, see the **VERSASSAGE** Jets

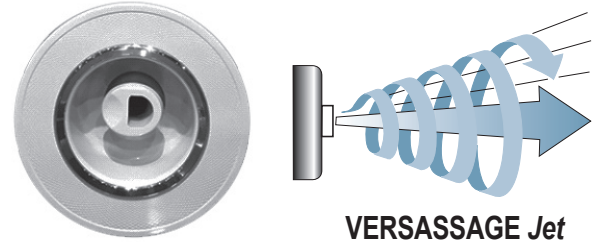

Maintenance section.

ORBISSAGE Jets - This jet provides a unique, pulsating massage. The flow is adjustable in that it can be turned completely off or on (by rotating the jet faceplate). It is also interchangeable with the **VERSASSAGE** jet. For cleaning or replacement instructions see **VERSASSAGE** Jets in the Spa Care and Maintenance section.



DIVERTER VALVES

The diverter valves on your spa allow you to direct the flow of water from the pumps to various combinations of jets. The functions of these diverter valves can best be learned by experimentation as follows:

Set all air controls to the "ON" position.

Turn on both pumps.

Turn the handle on each diverter valve and see which groups of jets are affected. (Note that you can adjust the diverter valves to any position between the two possible extremes to achieve the jet pressure that feels best to you.)

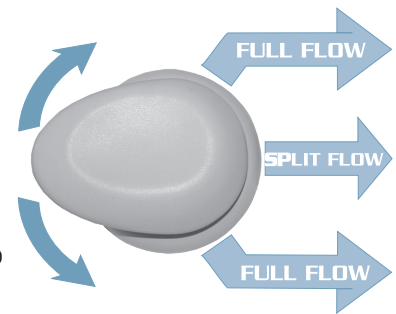

IMPORTANT: Your spa is not designed to provide full power to all jets when the diverter valves are in the "mid" position. However, with the diverter valve in this position, you may increase the power to selected jets by rotating the face of the **ADAPTAFLO** and **ADAPTASSAGE** jets to close the ones that are not in use.

TIP: Turn both pumps on and place the diverter valves to the "Mid-Position". Then experiment with each of the air controls to see their effect.

ACQUARELLA WATERFALL VALVE

Your spa is equipped with the **ACQUARELLA** waterfall feature. It is activated by turning on Jet Pump 2 (either low or high speed). The flow is regulated by turning the waterfall valve on the inside wall of the spa.



NOTE: On the **CANTABRIA**, Jet Pump 1 activates the waterfall to the left of the main control panel, and Jet Pump 2 activates the waterfall to the right of the main control panel.

AIR CONTROLS

Each jet system has its own air control. These allow you to change the power of the jets by regulating the amount of air that is mixed with the water coming out of the jets.



ATLAS NECK JET VALVE

All **UTOPIA** spas are equipped with 4 directional neck jets underneath the pillow of the EcstaSeat[®]. Two of these jet nozzles (located above the waterline) can be angled to a position that is comfortable for you. The flow of these neck jets can be regulated by turning the **ATLAS** Neck Jet valve on the inside wall of the spa.

CALDERA LOGO LIGHT

The **CALDERA** logo on the front of the spa illuminates a orange and gray color. These colors indicate the power and ready status of the spa without having to open the cover to look at the control panel.



Orange Indicator: The **ORANGE** indicator will light when the spa water temperature is within 2°F (1°C) of the set temperature, and will turn off when the temperature is outside of that range. If you increase or decrease the temperature setting of the spa, the ready indicator will turn off until the water temperature reaches the acceptable range for the new temperature setting. A flashing **ORANGE** indicator means a problem may exist with the temperature sensor. A one second on and 3 second off flashing **ORANGE** indicator means there is an issue with the salt system (see Troubleshooting section for more information).

Gray Indicator: The **GRAY** indicator is 'on' when the spa is properly supplied with power. It also provides a diagnostic function—a flashing **GRAY** indicator indicates that the heater high limit has tripped, meaning that either the spa water is above its acceptable temperature range, or a malfunction has occurred within the spa (such as low circulation due to clogged filters). An 'off' **GRAY** indicator means that there is a problem with the spa control box or the power supplied to the spa (see Troubleshooting section for more information).

QUICK START-UP INSTRUCTIONS

BEFORE YOU FILL YOUR SPA

Make sure your spa has been properly installed per all local codes, this includes the location of the spa, the foundation of the spa as well as the electrical installation of the spa. Installation instructions in the form

of a Pre-Delivery Instruction booklet can be obtained from either your **CALDERA** dealer or online.

DO:

- Know which water treatment system you will be using and make sure you have necessary chemicals available. Read all of the instructions that come with the system.
- Have **FRESHWATER** 5-way Test Strips Available.
- Have pH/Alkalinity Up & Down available.
- Know the calcium hardness of your water, contact your dealer to help you with this information. See Water Quality and Maintenance for more information.
IMPORTANT: The spa can be filled with "softened" water as long as the calcium hardness parameters (pg. 2) are maintained.
- Purchase the Clean Screen[®] pre-filter to remove unwanted contaminants from the tap water. This is recommended, not required.

DON'T:

- Power up the spa until it has been filled with water! Power to the spa automatically activates critical components within the spa, such as controls, heater, circulation pump, and other systems. If power is supplied to these components prior to the spa being filled, the components will be damaged, and this may result in a non-warranty component failure.
- Fill the spa with hot water or cold water with cold water temperature below 50° F (10° C)! Tripping of the high-limit thermostat may result causing your spa to stop functioning.
- Use your spa after filling until all of the steps listed below **START-UP** are completed!
- Add chlorine if treating your spa with polyhexamethylene biguanide (Biguanide, PHMB, eg. BaquaSpa[®]) sanitizer.

START-UP

Your **CALDERA** spa has been thoroughly tested during the manufacturing process to ensure reliability and long-term customer satisfaction. A small amount of water may have remained in the plumbing after testing and, as a result, may have spotted the spa shell or the spa siding prior to delivery. Before filling the spa, wipe the spa shell clean with a soft rag. The following instructions must be read and followed exactly to ensure a successful start-up or refill.

CAUTIONS



- **Do NOT fill the spa with hot water**, as tripping of the high-limit thermostat may result.
- **DO NOT CONNECT POWER TO AN EMPTY SPA.** Power to the spa automatically activates critical components within the spa, such as controls, heater, and other systems. If power is supplied to these components prior to the spa being filled, the components will be damaged, and this may result in a non-warranty component failure.
- **DO NOT** use your spa after filling until all of the steps listed below are completed.
- **DO NOT** add chlorine if treating your spa with polyhexamethylene biguanide (Biguanide, PHMB, eg. BaquaSpa[®]) sanitizer.
- Before filling your spa for the first time, remove the equipment compartment door and check to ensure that the unions on either side of the pump(s) and heater are hand-tight.

1. **CLOSE DRAIN, remove the filter compartment cover, skimmer basket, weir, and filter.** Fill your spa through the filter compartment using the CleanScreen™ pre-filter that attaches to your garden hose. The water level of your spa should be maintained at a level 1" (2.5 cm) above the highest jet in shell of spa. Reinstall the filter and then the skimmer basket, and weir once the spa is filled.

2. **AFTER THE SPA HAS BEEN FILLED** with water and the equipment compartment door is secured, power must be applied to the spa.

- FIRST activate power to the subpanel from the main house panel.
- NEXT open the door of the electrical subpanel and reset the GFCI breaker.
- FINALLY, close and secure the subpanel door.

3. **TO CHECK THE OPERATION OF THE JET SYSTEM** and to purge any remaining air from the heating system complete the following steps:

- Press the  icon on the Jet screen for each pump to place the jet pumps on High.
- Once the jet system is fully operational (as indicated by strong, non-surgling jets), priming of the spa is complete
- To turn off the jets, press the  on the jet screen to turn all functions off simultaneously.
- If you do not feel a steady stream of water from your jets, refer to the instructions for priming the pump in the SPA TROUBLESHOOTING section.

IMPORTANT: Be sure that the diverter(s) are in the middle position.

4. **SET THE TEMPERATURE CONTROL** to the desired temperature between 100°F (38°C) and 104°F (40°C), then place the spa cover on the spa and allow the water temperature to stabilize (approximately 24 hours). Make sure you secure the cover in place using the cover locks. Periodically check the spa water temperature. When the water temperature climbs above 90°F (32°C), proceed to the next step. The spa temperature is pre-programmed to reach 100°F (39°C), and will normally do so within 18 to 24 hours. You may change the water temperature by pressing the temperature on the home screen, then press the ▲ on the screen to raise the temperature, or ▼ to lower the temperature. After a few hours, the water temperature will remain within 3°F (1.5°C) of your selected temperature.

5. **USING A TEST STRIP AND APPLICABLE CHEMICALS**

adjust Total Alkalinity (TA) to 40-120ppm, calcium hardness (CH) 75-150ppm, then spa water pH between 7.2 and 7.8. These procedures are listed in the "Water Quality and Maintenance" section.

OPERATION NOTE: *Adjusting the Total Alkalinity as the first step is important, as out-of balance TA will affect your ability to adjust the pH correctly and will prevent the sanitizer from operating effectively.*

When using the FRESHWATER Salt system the calcium hardness must be 25-75ppm, if calcium hardness is above 75ppm use VANISHING ACT (see pg. 11).

IMPORTANT: *Activate the Clean cycle (Press  on the home screen then Start) before adding spa water chemicals directly into the filter compartment. Make sure all diverter valves are set to the middle position.*

6. **SUPERCHLORINATE THE SPA WATER** by adding 1½ teaspoons of chlorine (sodium dichlor) per 250 gallons (950 liters) of spa water, then activate the Clean cycle.

7. **TEST THE SPA WATER FOR CHLORINE RESIDUAL.** If the residual is between 3 and 5 ppm on the test strips, go on to the next step. If the residual is less than 3 ppm, activate the Clean cycle, and then retest, add more chlorine as necessary.

WARNING: *High sanitizer levels can cause discomfort to the user's eyes, lungs and skin. Always allow the sanitizer level to fall to the recommended range before using the spa.*

8. **RECHECK the Total Alkalinity (TA) 40-120ppm, calcium hardness (CH) between 75-150ppm, then spa water pH at between 7.2 and 7.8.**

OPERATION NOTE: *Make sure you adjust your Total Alkalinity and pH correctly, this will affect the sanitizers effectiveness.*

The spa is ready for use when the spa water has circulated and the chlorine level remains between 3 and 5ppm.

OPERATION NOTE: For proper water circulation during the ten-minute Clean cycle the following steps should be performed.

- Place the diverter valve in the middle (split flow) position.
- Place air control levers in OFF position by rotating clockwise.

WATER QUALITY AND MAINTENANCE

BASIC INFORMATION

It's important to have clean water. Water maintenance is one of the least understood, yet most important, areas of spa ownership. Your dealer can guide you through the process of achieving and maintaining balanced water in your spa, given your local conditions.

IMPORTANT: Water Terminology can be found at the end of this section.

- **Always read & refer to the owner's manual** for complete information.
- **Test your water** with a test strip once a week, or each time the spa is used.
- **Add chemicals** in frequent small amounts to prevent overdosing the spa.
- **Use the spa only** when the chlorine level is between 1-5 ppm manually add chlorine as needed.
- **It is the spa owner's responsibility** to prevent over or under chlorination.

IMPORTANT: Remember to change your water every three to four months (up to 1 year when using the **FRESHWATER IQ Smart Monitoring System**). Check with your **CALDERA** dealer to determine if water in your region has unique qualities - such as high metal or mineral content - that should be addressed, especially when using the **FRESHWATER Salt System**.

Your program will depend on your water's mineral content, how often you use your spa, and how many people use it.

WATER QUALITY CHART

PARAMETER	TARGET	MIN - "OK" RANGE - MAX	
pH	7.4	7.2	7.8
ALKALINITY	80 ppm	40 ppm	120 ppm
HARDNESS	100 ppm	75 ppm	150 ppm
HARDNESS (SALT SYSTEM)	50 ppm	25 ppm	75 ppm
CHLORINE	3 ppm	1 ppm	5 ppm

Maintaining the water quality and the cleanliness of the filters in your spa is your responsibility. Keeping the spa water balanced prolongs the life of the spa components and will make the water more comfortable. Your dealer can guide you through the process of achieving and maintaining perfect water in your spa, given your local conditions. Your program will depend on your water's mineral content, how often you use your spa, and how many people use it. **WATKINS WELLNESS** has developed several water care systems and products to simplify water care which are available from authorized **CALDERA** dealers.

FRESHWATER Salt System	Vanishing Act® Calcium Remover
FRESHWATER Salt Test Strips	FRESHWATER 5-way Test Strips
FRESHWATER Smart Monitoring System	CLEAN SCREEN Prefilter

CHEMICAL SAFETY

When using chemicals, read the labels carefully and follow directions precisely. Though chemicals protect you and your spa when used correctly, they can be hazardous in concentrated form. Always observe the following guidelines:

- Allow only a responsible person to handle spa chemicals. Keep them out of the reach of children.
- Accurately measure the exact quantities specified, never more. Do not overdose your spa.
- Handle all containers with care. Store in a cool, dry, well ventilated place.
- Always keep chemical containers closed when not in use. Replace caps on their proper containers.
- Don't inhale fumes, or allow chemicals to come in contact with your eyes, nose, or mouth. Wash your hands immediately after use.
- Follow the emergency advice on the product label in case of accidental contact, or if the chemical is swallowed. Call a doctor or the local Poison Control Center. If a doctor is needed, take the product container along with you so that the substance can be identified.
- Don't let chemicals get on surrounding surfaces or landscaping. Don't use a vacuum cleaner to clean up chemical spills.
- Never smoke around chemicals. Some fumes can be highly flammable.
- Don't store any chemicals in the spa equipment compartment.

HOW TO ADD CHEMICALS TO THE WATER

IMPORTANT: All spa water chemicals must always be added directly into or in front of the filter compartment while a jet pump is running, and it must run for a minimum of ten minutes.

TO ADMINISTER SPA WATER CHEMICALS:

1. Fold back the cover and remove the filter compartment cover.
2. To activate the Clean Cycle, press  on the Home Screen and **Start** below **Clean Screen**.
3. Carefully measure the recommended amount of chemical and slowly pour it over the filter basket area. Use care not to splash chemicals on your hands, in your eyes, on the spa sheet surface, or on the siding.
4. Replace the filter compartment cover and close the spa cover.
Risk of Drowning: Never leave an open spa unattended!

⚠ WARNING: High sanitizer levels can cause discomfort to the user's eyes, lungs and skin. Always allow the sanitizer level to fall to the recommended range before using the spa.

IMPORTANT "SUPER CHLORINATION/NON-CHLORINE SHOCK TREATMENT" NOTE: After administering a super chlorination treatment or non-chlorine shock to your spa, leave the cover open for a minimum of 20 minutes to allow the oxidizer gas to vent. A high concentration of trapped oxidizer gas which may exist as a result of the shock treatment (not daily sanitation) may eventually cause discoloration or degradation to the bottom of the cover. This type of damage is considered chemical abuse and is not covered under the terms of the limited warranty.

FUNDAMENTALS OF WATER MAINTENANCE

- **Testing:** Test the water weekly or each time the spa is used with convenient **FRESHWATER** 5-way Test Strips or more accurate liquid/tablet reagent test kit per instructions. Critical parameters: sanitizer level, pH, Calcium Hardness (CH), and Total Alkalinity (TA). Store test equipment in a dark, cool, dry place to maintain potency.
- **Water Filtration:** The filtration used in **CALDERA** spas helps keep water clean by circulating sanitizer and removing waste from the spa. Regularly inspect and clean filters for peak performance.
- **Chemical Balance/pH Control:** It is important to adjust the primary water parameters (Total Alkalinity, Calcium Hardness, pH) into the recommended ranges so that they are stabilized or balanced. Balance the water chemistry every time you fill the spa with new water and then during the life of that body of water. Keeping the water in balance prevents damage by holding the pH in a safe range and preventing calcium scale formation on spa equipment. A low pH can damage metal components whereas a high pH can cause high levels of calcium to form scale. Your dealer should provide a detailed water chemistry orientation soon after your new spa is filled for the very first time.

ALKALINE SPA WATER (SCALING ZONE)	8.2	ADD pH DECREASER TO LOWER pH
	7.8	
COMFORT ZONE	7.6	IDEAL
	7.4	
	7.2	
ACIDIC SPA WATER (CORROSIVE ZONE)	6.8	ADD pH INCREASER TO RAISE pH
	pH	

- The following three water components must be kept in balance to avoid damage to the spa. Do balance these components in the order they are listed here as each will help you balance the next using a minimum amount of chemicals.
 1. Calcium Hardness (CH) – CH is the measure of the amount of dissolved calcium in the water. Low levels can make the water corrosive and high levels cause scale formation of spa components. The recommended CH reading is between **75 - 150 ppm**. A calcium hardness between **25 - 75 ppm** is recommended with the **FRESHWATER** Salt System. If the CH level is too high, lower it with the **VANISHING ACT** calcium remover per instructions. Once in balance, the CH reading normally remains stable until new water is added. Great care must be taken when filling the spa from a water softener to ensure that the calcium remains in balance and avoids damage to the spa.
 2. Total Alkalinity (TA) - TA is a measure of the water's ability to resist changes of pH or buffer capacity. A low TA allows the pH to fluctuate easily. The recommended TA reading is between **40 - 120 ppm**. To raise the TA, use pH/Alkalinity Up (sodium hydrogen carbonate). To lower the TA, use pH/Alkalinity Down (sodium bisulfate). Once the TA is balanced, it normally remains stable until the next drain/refill. We recommend you check the TA reading once per month. Raising/lowering the TA may cause the pH readings to fluctuate widely. Ignore the pH readings on the test strip while you are balancing the TA.
 3. pH - The pH is the measure of the acidity and alkalinity. Maintaining the proper pH level will optimize the effectiveness of the sanitizer, preventing damage to the spa and physical discomfort for spa users. A low pH dissipates sanitizer, causes corrosion, and irritates spa users. A high pH level will neutralize sanitizer, promote scaling and cloud water. The recommended pH reading is between

7.2 - 7.8. To lower the pH level, use pH/Alkalinity Down (sodium bisulfate). To raise the pH level, use pH/Alkalinity Up (sodium carbonate).

- **Water Conditioners:** Spa fill water varies from location to location and user to user, therefore it is important to consult with your dealer for an appropriate program.
 - a. **VANISHING ACT** – High levels of calcium and some minerals can be removed from the water with the single use **VANISHING ACT**. High calcium levels can cause scale formation on the spa equipment and shell (see page 11 for instructions).
 - b. **CLEAN SCREEN** pre-filter –The **CLEAN SCREEN** pre-filter should be used at every fill and top-off to remove contaminants from the fill water, especially iron, copper, and manganese. Many water sources including well water contain high concentrations of minerals that can cause staining of the shell and plastics.
 - c. Stain and Scale control – For water high in calcium and minerals, it may be necessary to use an anti-scalant like Stain and Scale control. As water evaporates from your spa and new water is added, the amount of dissolved minerals like calcium, copper, iron, and manganese will increase. (Minimize evaporation by keeping the cover on the spa whenever possible.) High iron or copper content in the water may produce green or brown stains on the spa.
 - d. Foam Inhibitors - Soap is introduced into the spa water from users' bodies and swimming apparel and can cause the spa water to foam when the jets are used. Low levels of calcium hardness (soft water) can increase foaming. Although ozone can oxidize soap residual, it may become necessary to add Foam Inhibitors to suppress the foam. Excessive soap in the water may require a water change to resolve.
- **Oxidizers:** Ozone and Monopersulfate (MPS) are oxidizers used to prevent the buildup of contaminants, maximize sanitizer efficiency, minimize combined chlorine, and improve water clarity. They are to be used in conjunction with EPA registered sanitizers. The high output, Corona Discharge ozone system produces a high concentration of ozone which is injected into the spa water 24 hours per day. Chlorine-Free Oxidizer, Monopersulfate (MPS) is a granular oxidizing chemical.
- **Sanitizers:** Maintaining the recommended residual level of an EPA registered sanitizer at all times will decrease the occurrence of unsafe bacteria and viruses in your spa water. The recommended Free Available Chlorine (FAC), the amount of available chlorine sanitizer, is **3.0 - 5.0 ppm**. A low FAC can allow bacteria and viruses to grow rapidly in the warm water, and a high FAC can cause discomfort to the user's eyes, lungs, and skin. Each sanitizer carries its own instructions regarding how much to use and when to add it to the spa water. Consult your dealer for their recommendations and instructions on proper sanitizing of the spa.

WATKINS WELLNESS recommends the following sanitizers:

- **FRESHWATER** Salt System
- Concentrated chlorinating granules (dichlor)
- Liquid chlorine (sodium hypochlorite)

WATKINS WELLNESS also approves the following sanitizers:

- Biguanide

WARNING: DO NOT use tri-chlor chlorine, bromo-chloro-dimethyl-hydantoin (BCDMH), or any type of compressed bromine or chlorine, acid or any type of sanitizer which is not recommended by **WATKINS WELLNESS**.

THE CALDERA SPA WATER MAINTENANCE PROGRAM

FILLING THE SPA WITH WATER

Use the **CLEAN SCREEN** pre-filter to remove unwanted contaminants such as rust, dirt, detergents, and algae from the fill water. Dissolved metals, copper, iron, and manganese are also removed. Instructions are included with the **CLEAN SCREEN** pre-filter. Always fill the spa through the filter compartment. Do not fill your spa using water from a swimming pool as pool chemicals are very different from those used in a spa and can damage your spa.

ADDING CHEMICALS TO THE WATER

All spa water chemicals, including granulated dichlor, MPS, granulated pH increaser or decreaser, granulated total alkalinity increaser, liquid stain and scale inhibitor, and liquid defoamer must always be added directly into the filter compartment while the jet pump is running in its high speed mode, and it must run for a minimum of ten minutes with the cover off. Use the Clean icon feature to ensure that the chemicals are properly mixed when adding.

BUILDING A SANITIZER ROUTINE

During the first month of ownership, measure the sanitizer residual daily in order to establish a baseline of sanitizer needed vs. spa usage. Sanitizer needed is the amount of Free Available Chlorine needed to accommodate the number of users and their combined usage time. For example, two spa users for twenty minutes every day creates regular demand on the sanitizer that is used to determine how much sanitizer to add in order to maintain the proper residual. If the usage pattern increases dramatically with invited guests, the amount and frequency of sanitizer required increases dramatically.

MANUAL CHLORINE (SODIUM DICHLOR)

WATKINS WELLNESS recommends the use of Concentrated Chlorinating Granules (sodium dichlor) for sanitizing the water. Sodium dichlor is preferred because it is totally soluble, dissolves quickly, and is nearly pH neutral. The recommended Free Available Chlorine (FAC), the amount of available chlorine to sanitize the spa, 3.0-5.0 ppm.

If the FAC is too low: Increase the FAC by adding granulated sodium dichlor.

If the FAC is too high: Allow time to pass and the FAC level will naturally drop over time.

If the spa smells of chlorine: Super chlorinate or shock the spa. FAC chlorine does not have an odor whereas combined spent chlorine (chloramines) has a strong chlorine odor that can be eliminated by shocking the water.

IMPORTANT: There are several forms of stabilized chlorine available for use in spas and swimming pools. It is extremely important to choose one specifically designed for spas. Use of an incorrect product such as tri-chlor which has a very low pH (2.6) and dissolves too quickly in hot water, results in extremely high levels of chlorine that **WILL** cause damage to your spa. Use of a compressed bromine/chlorine or unapproved sanitizer **WILL** damage your spa and is specifically not covered under the terms of the limited warranty.

PERFORMING SUPER CHLORINATION/ NON-CHLORINE SHOCK TREATMENT

A weekly or monthly super chlorination (1.5 tsp dichlor/250 gal) or shock (4tbsp mps/250 gal) may be required of your chosen sanitation program. Increasing chlorine to 5 ppm for 24-48 hours removes excess waste and chloramines from the water. Sodium dichlor is 6x stronger than MPS and may be a more appropriate for those users that experience heavy bather load conditions. Operate all jets and leave the cover open for a minimum of 20 minutes to allow the oxidizer gas to vent to prevent damage and discoloration to the cover and pillows after administering a super chlorination or shock to your spa. This type of damage is considered chemical abuse and is not covered under the terms of the limited warranty.

IMPORTANT: Always allow the Free Available Chlorine to fall below 5 ppm before using your spa.

⚠ DANGER: Never leave an open spa unattended, especially if there are children present!

FRESHWATER IQ

The **FRESHWATER IQ** system consists of the **FRESHWATER Smart Monitoring System** and the **FRESHWATER Salt system**.

FRESHWATER SMART MONITORING SYSTEM

The **FRESHWATER Smart Monitoring System** uses breakthrough technology to test your water every hour. It then tells you what you need to do to maintain clean, clear and balanced water.

FRESHWATER SALT SYSTEM

The **FRESHWATER Salt System** converts water and sodium chloride salt into chlorine sanitizer. The **FRESHWATER Salt System** is compatible with chlorine based systems and chemicals. Although the system is reduced maintenance, it is not automatic. It is important that the user regularly tests and balances the water. A calcium hardness between **25 - 75ppm** is recommended to extend the life of the hardware. Consult the **FRESHWATER Salt System** manual for additional instructions.

ADDITIONAL FRESHWATER WATER CARE PRODUCTS

- **FRESHWATER CLEAN SCREEN** Pre-filter
- **FRESHWATER** Concentrated Chlorinating Granules
- **FRESHWATER** Monopersulfate (MPS), Chlorine-Free Oxidizer (not compatible with **FRESHWATER Smart Monitoring System**)
- High output ozone system (not compatible with **FRESHWATER Smart Monitoring System**)
- **FRESHWATER Mineral Spa Sanitizer** (not compatible with **FRESHWATER Smart Monitoring System**)

It is important to follow the recommended application and maintenance programs outlined for each product's use. If the spa is being used over an extended period of time, such as a whole afternoon or evening, additional sanitizer will be needed.

IMPORTANT: Use only granulated sodium dichlor or liquid chlorine sanitizer. Silver is not compatible with bromine and biguanides. Don't use a water clarifier. Clarifiers will cause the spa water to become cloudy.

VANISHING ACT INSTRUCTIONS

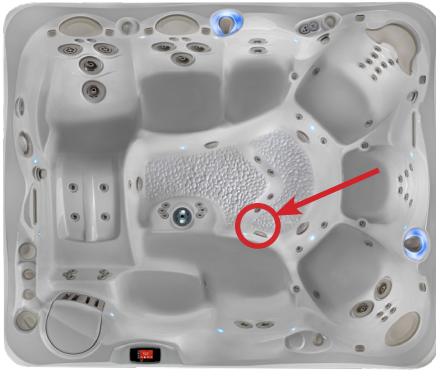

CANTABRIA

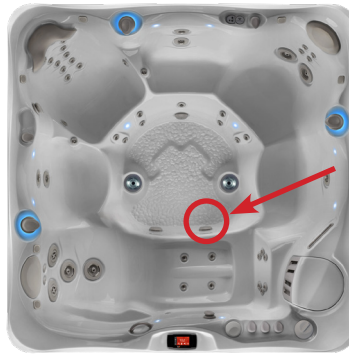

GENEVA

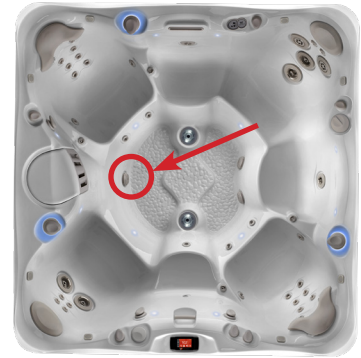

NIAGARA



TAHITIAN



FLORENCE



RAVELLO

Instructions for Use:

1. After Filling your hot tub, use a test strip to measure the calcium hardness level of the water. If calcium hardness is above **100 ppm**, use the **VANISHING ACT** calcium remover to soften the water.
Suggested Calcium Hardness Level: between 75 - 150 ppm, (it must be between 25 - 75 ppm when using the FRESHWATER Salt System in order to work).
2. Rinse the **VANISHING ACT** calcium remover with running water until water runs clear. When placed in the hot tub, slight color transfer to the water may occur and can be easily resolved with chlorine.
3. Locate your spa above to determine which jet suction fitting the **VANISHING ACT** calcium remover will be placed up over. Use the circle to determine location.
 - a. Press  on Home screen to display the **Clean Cycle** screen. Press **Start** below **VANISHING ACT** to start jet pump on low speed.
 - b. Place the **VANISHING ACT** calcium remover firmly against the associated jet suction fitting.
 - c. Test the spa water for hardness after jets shut off, this will take around 6 hours.

IMPORTANT:

- **Always make sure water is balanced and properly sanitized, using the EPA approved sanitizer, before entering your hot tub.**
- **For maximum effectiveness, ensure that the calcium remover remains on the suction fitting while the calcium remover is in use.**
- **Calcium remover may not be necessary if water hardness is already in or below the suggested range.**
- **Multiple calcium removers maybe needed if initial water hardness is above 200 ppm.**

OZONE MAINTENANCE (IF EQUIPPED)

NOTE: Not compatible with **FRESHWATER** Smart Monitoring System.

If Reduced or no ozone bubbles are coming from the heater return (clogged ozone injector) or no ozone, clean the injector:

⚠ DANGER: Nitric acid accumulates in the air lines of the ozonator and injector, and will cause severe chemical burns if direct skin contact is made. Always wear protective gloves, glasses and clothing when working on the ozonator or injector lines. To prevent inhalation or ingestion of the nitric acid, DO NOT blow or inhale with your mouth to any of the adapters, fittings or tubing of the ozonator or injector air lines.

1. Place 16 ounces (.5 liter) of white vinegar into a cup or bucket.
2. Carefully loosen the long tubing attached to the bottom of the ozonator, located in the equipment compartment.
3. Place the end of the tubing into the vinegar, making certain that the end of the tubing sits at the bottom of the container.
4. Run the spa until all 16 ounces (.5 liter) of the vinegar is gone. This should allow an ample flow of vinegar to be run through the injector and clear the blockage.
5. Reinstall the tubing to the bottom of the ozonator.

Water chemistry damage is not covered by the warranty. The chemical levels and water quality in the spa are under your direct control. With proper basic care, the spa will provide many years of hot water relaxation. If you are unsure about any chemical or its usage in the spa, contact your Authorized Dealer, or **WATKINS WELLNESS**.

DO:

- Add all chemicals slowly into the filter compartment with the jet pump operating for ten minutes.
- Use special care if using baking soda to clean either the interior or exterior plastic surfaces.
- Use granular (dichlor) or liquid (sodium hypochlorite) chlorine.

IMPORTANT: WATKINS WELLNESS DOES NOT recommend the use of any floating chemical dispenser. Damage to the spa shell or components caused by a floating chemical dispenser is specifically not covered under the terms of the limited warranty. Floating dispensers can become trapped in one area and cause an over-sanitization or release large chunks of sanitizer that very quickly chemically burn the shell and cover.

DON'T:

- Use compressed sanitizers.
- Use a floater type sanitization system as a low or no maintenance solution to your spa maintenance program.
- Use a sanitizer which is not designed for spas.
- Use swimming pool (muriatic) acid to lower pH.
- Broadcast or sprinkle the chemicals onto the water surface. This method may cause chemically-induced spa surface blistering (chemical abuse).

VACATION WATER CARE INSTRUCTIONS

If you plan to be away from home, follow these instructions to ensure that the water quality of your spa is maintained:

SHORT TIME PERIODS (3-5 DAYS)

1. Adjust the pH by following the instructions outlined in the Water Quality and Maintenance section.
2. Sanitize the water by following the shock procedures also listed in the Water Quality and Maintenance section.
3. Lock your cover in place using the coverlocks.
4. Upon your return, sanitize the water by following the shock procedures, and balance the pH.
5. If **FRESHWATER** Salt System is installed, please refer to Tips section, vacation or limited use in the Salt System Owner's Manual.

LONG TIME PERIODS (5-14 DAYS)

Prior to leaving:

1. At least one day before you leave, set the temperature to its lowest level. This setting should represent an approximate water temperature of 80°F (27°C)
IMPORTANT: Spa water oxidizers such as sodium dichlor (chlorine) maintain their level of effectiveness substantially longer in warm water 80°F (27°C) than in hot water 101°F to 104°F (38°C - 40°C).
2. Adjust the pH as required. Sanitize the water by following the shock procedures.

Upon your return:

3. Sanitize the water by following the shock procedures. Return the set temperature to its original setting. The spa water will be safe for you to use once the Free Available Chlorine residual level has dropped below 5.0 ppm.
IMPORTANT: If you will not be using your spa for an extended period of time (in excess of 14 days) and an outside maintenance service (or neighbor) is not available to assist with the water maintenance, draining or winterizing of the spa is recommended.

SUPPLEMENTAL WATER MAINTENANCE

Proper water sanitation and mineral balance (pH control) are absolutely essential for a complete spa water maintenance program. Here are two other popular water additives that are optional:

Mineral Deposit Inhibitors

As water evaporates from your spa and new water is added, the amount of dissolved minerals will increase. (Minimize evaporation by keeping the cover on the spa whenever possible.) The spa water may eventually become "hard" (Calcium Hardness too high) enough to damage the heater by calcifying its surface. Proper pH control can minimize this.

Normal soap build-up will require water replacement regularly enough that mineral deposits normally are not a problem.

Occasionally, high iron or copper content in the water may produce green or brown stains on the spa. A stain and scale inhibitor may help to reduce these metals.

IMPORTANT: Well water may contain high concentrations of minerals. The use of a low water volume, extra-fine pore water filter (in-line pre-filter such as the **CLEAN SCREEN** pre-filter) will help to remove many of the larger particles during the filling of the spa. In-line pre-filters can be purchased at your local **CALDERA** dealer.

Foam Inhibitors

Spa water requires changing due to the buildup of soap in the water. Typically, soap will cause the spa water to foam when the jets are used. Soap is introduced into the spa water from two sources: users' bodies, which retain a soap residual after showering, and swimming apparel, which retains soap after washing.

Foam inhibitors can suppress foam, but cannot remove soap from the water. Soap is very difficult to remove from the water because soap is not oxidized by any chemical added to the spa. Only ozone can oxidize soap. Eventually the soap build-up in the water will be concentrated, resulting in an unclear feeling on the bather's skin, which is impossible to remedy. When this occurs, it's time to drain and refill the spa. Depending on the soap input, the water should last about four months before needing to be drained.

GLOSSARY

The following chemical terms are used in this Water Quality and Maintenance section. Understanding their meaning will help you to better understand the water maintenance process.

Bromamines: Compounds formed when bromine combines with nitrogen from body oils, urine, perspiration, etc. Unlike chloramines, bromamines have no pungent odor, and are effective sanitizers.

Bromine: A halogen sanitizer (in the same chemical family as chlorine). Bromine is commonly used in stick, tablet, or granular form however, stick and tablet form should NOT be used.

Calcium Hardness: The amount of dissolved calcium in the spa water. This should be between 75 - 150ppm (Salt System: between 25 - 75ppm). High levels of calcium can cause cloudy water and scaling. Low levels can cause harm to the spa equipment.

Chloramines: Compounds formed when chlorine combines with nitrogen from body oils, urine, perspiration, etc. Chloramines can cause eye irritation as well as having a strong odor. Unlike bromamines, chloramines are weaker, slower sanitizers.

Chlorine: An efficient sanitizing chemical for spas. **WATKINS WELLNESS** recommends the use of sodium dichlor-type granulated chlorine. This type is preferred because it is totally soluble and nearly pH neutral.

Chlorine (or Bromine) Residual: The amount of chlorine or bromine remaining after chlorine or bromine demand has been satisfied. The residual is, therefore, the amount of sanitizer which is chemically available to kill bacteria, viruses and algae.

Corrosion: The gradual wearing away of metal and plastic spa parts, usually caused by chemical action. Generally, corrosion is caused by low pH or by water with levels of TA, CH, pH or sanitizer which are outside the recommended ranges.

Halogen: Any one of these five elements: fluorine, chlorine, bromine, iodine, and astatine.

MPS: Monopersulfate is a non-chlorine oxidizer.

Nitric Acid: The formulation of nitric acid, a highly corrosive chemical, is a byproduct of the ozone generating process. Nitric acid is produced in very small quantities and is readily dissolved in the water stream with ozone.

Oxidizer: The use of an oxidizing chemical is to prevent the buildup of contaminants, maximize sanitizer efficiency, minimize combined chlorine and improve water clarity. See MPS and Ozone.

Ozone: Ozone is a powerful oxidizing agent which is produced in nature and artificially by man. Ozone forms no byproducts, oxidizes chloramines, and will not alter the water's pH.

pH: The measure of the spa water's acidity and alkalinity. The recommended pH for the spa water is 7.2 to 7.8. Below 7.0 (considered neutral), the spa water is too acidic and can damage the heating system. Above 7.8, the water is too alkaline and can result in cloudy water, and scale formation on the shell and heater.

ppm: The abbreviation of "parts per million", the standard measurement of chemical concentration in water. Identical to mg/l (milligrams per liter).

Reagent: A chemical material in liquid, powder, or tablet form for use in chemical testing.

Sanitizer: Sanitizers are added and maintained at recommended residuals to protect bathers against pathogenic organisms which can cause disease and infection in spa water.

Scale: Rough calcium-bearing deposits that can coat spa surfaces, heaters, plumbing lines, and clog filters. Generally, scaling is caused by mineral content combined with high pH. Additionally, scale forms more readily at higher water temperatures.

Super-Chlorination: Also known as "shock treatment." Super-Chlorination is a process of adding significant doses of a quick dissolving sanitizer ("dichlor" is recommended) to oxidize non-filterable organic waste and to remove chloramines and bromamines.

Total Alkalinity (TA): The amount of bicarbonates, carbonates, and hydroxides present in spa water. Proper total alkalinity is important for pH control. If the TA is too high, the pH is difficult to adjust. If the TA is too low, the pH will be difficult to hold at the proper level. The desired range of TA in spa water is 40 to 120 ppm.

OPERATING INSTRUCTIONS

MAIN CONTROL PANEL

The main control panel features a full color LCD touchscreen that provides a quick visual check of the spa's status and allows the user to set the temperature, activate the jets & lights, lock the temperature and/or spa functions. Other optional functions may also be available depending on the spa model and accessory equipment that has been installed into the spa.



HOME SCREEN

When activating a function or feature, press with a light but distinctive touch, the function or feature will activate as your finger is removed from the touchscreen.





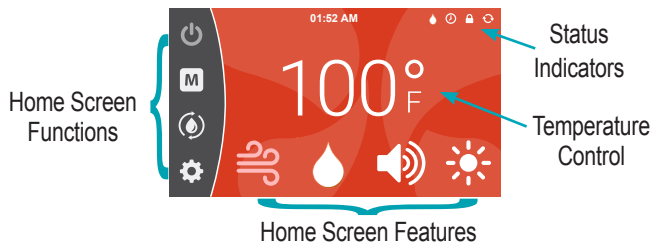

IMPORTANT: Never sit, stand or lean on the LCD touchscreen when entering or exiting the spa because it may damage the screen.





The Home screen is the default screen. The temperature displayed inside the Home screen is the actual temperature of the spa water.









CARE OF YOUR SCREEN:

Use only a clean microfiber cloth and water to clean your LCD screen. Abrasive cloths, towels, paper towels, and similar items may cause damage to the screen. Don't use around aerosol sprays, solvents, or abrasives.

Home Screen Functions:		
	Power	Press this icon to turn jets on high and all lights on blue if both are currently off, or will turn all jets, lights, and music off if those features are currently on.
	Memory Screen	Press this icon to access the Memory screen.
	Clean Cycle	Press this icon to access the Clean Cycle screen. Icon will flash when Clean Cycle is on.
	Settings Screen	Press this icon to access the first Settings screen.

Home Screen Features		
	Jets	Press this icon to access the Jets Control screen.
	Freshwater IQ Smart Monitoring System	When installed, press this icon to access the Water Care screen.
	Music	<i>If installed</i> , press this icon to access the first Music screen.
	Lights	Press this icon to access the first Lighting screen.
	Clock	Press this icon to access the clock setting features.

Status Indicators		
	Timer	This indicator is on whenever a timer is set and activated.
	Spa/Temp Lock	This indicator is on whenever the Spa Lock or Temperature Lock is ON.
	Invert Screen	Press this indicator to invert the screen.
	FRESHWATER IQ Smart Monitoring System	This indicator appears when the FRESHWATER cartridge is over 4 months old and should be changed.

Working Screen Icons		
	Home Icon	Press to return to the Home screen.
	Return Icon	Press to return to the previous screen.
	Advance Icon	Press to advance to the next screen.

HOME SCREEN FUNCTIONS

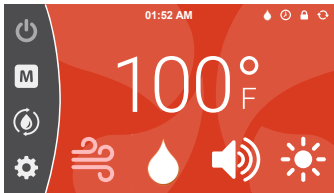

Press the on the Home screen to turn jets on high and all lights on blue if both are currently off, or will turn all jets, lights, and music off if any of those features are currently on.

MEMORY SCREEN

Press on Home screen to display Memory screen.

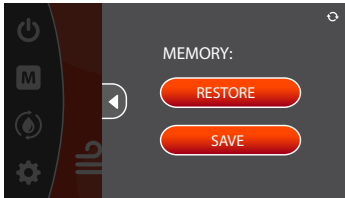

The Memory Screen will allow you to take your favorite combinations of jets and lights and save them to be used at any time.



Press to activate the last saved set of operating functions.



Press to save the current set of operating functions (jets and lights only).

CLEAN CYCLE SCREEN

Press on Home screen to display Clean Cycle screen.

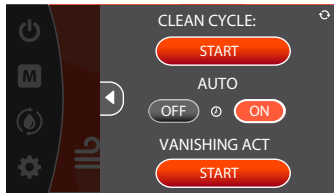

Press to start the manual Clean Cycle. The screen will briefly display CLEAN CYCLE: ACTIVE. Activates jet pump 1 on high speed for a ten minute period



Press Auto ON to display the Auto Clean Cycle screen.

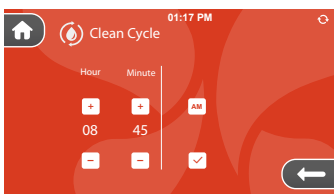

In the Auto Clean Cycle Screen you will be able to set the time of day you would like the clean cycle to run every day.

NOTE: The clean cycle time CAN NOT overlap with the Energy Savings Mode.

- Use the + or - buttons under Hour and Minute to set the exact time of day you would like the clean cycle to go on.
- Set for AM or PM (the AM/PM button will ONLY display when clock is set to 12 hour mode).
- Press the button to Activate the Auto Clean cycle to run at the time of day you set. Press to deactivate Auto Clean cycle.

When activated, a clean cycle will run Jet 2 for 1 minute and Jet 1 for 9 minutes. Status Indicator will show up on top of screen when in Auto Cycle mode and Clean Cycle icon will flash on home screen when the cycle is ON.

VANISHING ACT CYCLE

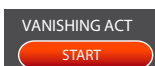

Press on Home screen to display the VANISHING ACT screen.

Press to start the **VANISHING ACT** cycle activating the low speed jet pump for 6 hours, ONLY to be used with **VANISHING ACT** (page 11).

SETTINGS SCREENS

Press on Home screen to display first Settings Screen.



The first Settings screen allows you to turn Temperature Lock, Spa Lock, Lights Timer On or Off.

TEMPERATURE LOCK

Press on Home screen to display Temperature Lock.



The Temperature Lock feature prevents changing the desired water temperature setting. All other control panel functions will operate normally while the Temperature Lock is "ON".

Press and hold ON or OFF for **approximately 4 seconds** to activate or deactivate.

SPA LOCK

Press on Home screen to display Spa Lock.

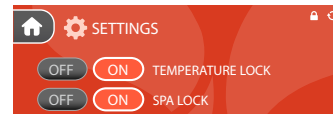

When activated, the Spa Lock feature disables all functions on the control panel.

The control panel will not respond to anything except on the Home screen.

Press and hold ON or OFF for **approximately 4 seconds** to activate or deactivate.

LIGHTS TIMER

Press on Home screen to display Lights Timer.



When activated, the exterior lights of the spa will come on at a preset time and will remain lit for set

duration, it will then repeat the cycle every day from the preset time.

Press ON to bring up the Lights set time and duration screen.

Set the Time of day you want to turn exterior lights on and off.

1. Set the hour and minute of the day by pressing the + or - buttons under Hour and Minute.
2. Press the AM or PM (when clock is set up for 12 hour time).
3. Set the Duration from 1 - 6 hours by pressing the plus or minus button under Duration.

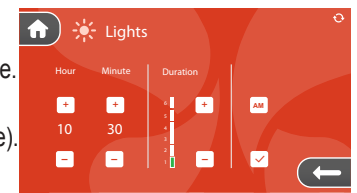

4. Press the button to activate Exterior light timer.

You can deactivate the timer by pressing the button when Exterior light timer is activated or press the OFF button on the lights timer screen.

Status Indicator will appear on top of the screen when timer is activated.

TEMPERATURE °F/ °C SETTING

Press on Home screen to display first Settings screen, then press

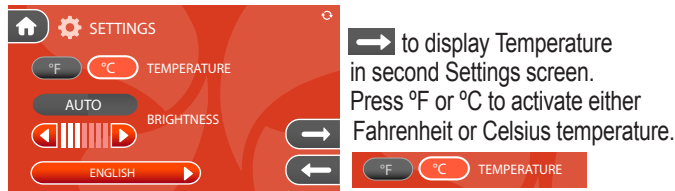

SCREEN /LOGO LIGHT BRIGHTNESS

Press on Home screen to display first Settings screen, then press to display Brightness in second Settings screen. Press Press to activate the auto brightness feature, a sensor will automatically adjust the LCD to the ambient lighting conditions.

Press or to turn AUTO brightness off and manually increase or decrease the brightness of the remote's screen. Press and hold either arrow to continuously change the brightness setting.

To change the logo light brightness, press and hold for 5 seconds, AUTO will change to . Use below LOGO LIGHT to increase or decrease the brightness. Press the HOME icon or return arrow to exit the screen.

INFORMATION SCREEN

Press button in second Settings screen to display Software Information screen.

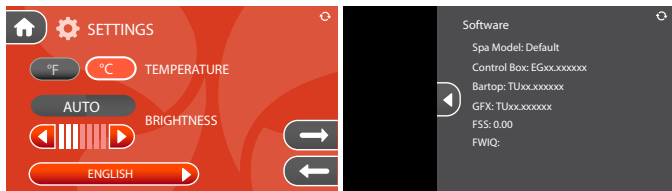

LANGUAGE

Press on Home screen to display first Settings screen, then press to display Brightness in second Settings screen.

The control panel screens can be viewed in different languages.

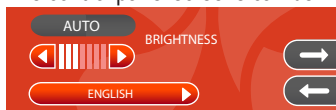

Press Press to display Select Language screen.

NOTE: Press to see more languages.

Press and hold on the new desired language until it turns green.

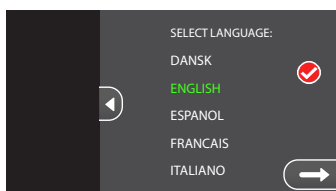

Press to start the conversion process. The conversion is finished once the Home screen reappears.

Press to return to second Settings screen if check mark icon is not pressed. Screen will automatically revert back after 10 seconds of non activity.

CLOCK SCREEN

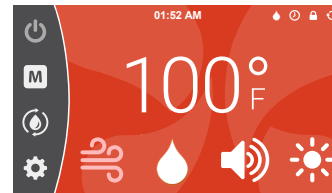

Press the Clock on the main screen to display the larger clock time screen with a settings icon and a clock icon.

Press the button to enter into the Clock setting screen to set the current time for the spa's clock.



- Determine if you want 12 hour (AM/PM) or 24 hour time by sliding the button to change it to from one time to the other.
- When using the AM/PM, select what time of day it currently is by sliding the button to either AM or PM.
- Select the time of day by pressing the + or - buttons below hour and minute.
- Once you have the current time set, simply press the button to set the new time.

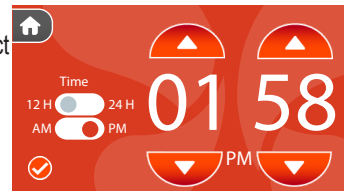

NOTE: If the power to the spa is disconnected, the clock time remains in memory and will NOT need to be reset.

SOAK TIMER

The Soak Timer is used as an alarm clock to let you know you have been in the tub for 15 minutes. If jets are on at the end of the timer then they will be turned off letting you know your time is up. If there are no jets on then jet pump 1 will turn on high speed for 5 seconds then turn off.

To access the Soak Timer, press the clock on the main screen followed by the button in the large clock screen.

NOTE: To set Soak Timer for a 30, 45 or 60 minute soak time, press and hold for several seconds and you will see the Soak Timer screen.

Press + or - button until desired soak time is shown followed by to activate soak timer.

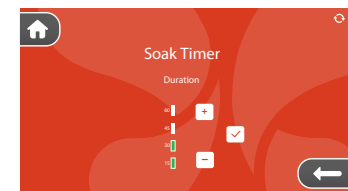
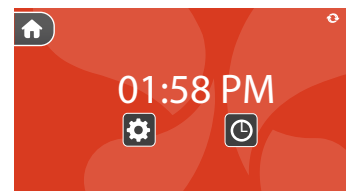

TEMPERATURE CONTROL

100°F

Press the actual temperature on Home screen to display Set Temperature screen.

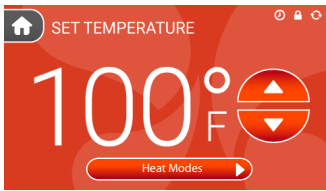

The set temperature range is from 80°F to 104°F (26°C to 40°C).

NOTE: The water temperature may vary depending on the current use and condition of your spa and outside temperatures.

The factory set temperature of the spa water is 100°F (38°C).

The last temperature value set by the user will be stored in memory. If power is disconnected from the spa, it will automatically revert to the last set temperature when power is reapplied.



Press to raise set temperature of spa. Press and hold to raise the temperature continuously.



Press to lower set temperature of spa. Press and hold to lower the temperature continuously.



Press to Display the Energy Saving Mode screen Figure 1. **NOTE:** If Optional CoolZone® is install you will see the Heat Mode screen with additional **COOLZONE** screen menu Figure 2. See **COOLZONE** Manual for additional information.

ENERGY SAVING MODE

This mode allows you to save energy by shutting off the heater at two predetermine times of the day for up to 6 hours on each setting.

Press the "Energy Saving Mode" text on the screen to advance to the next screen Figure 3.

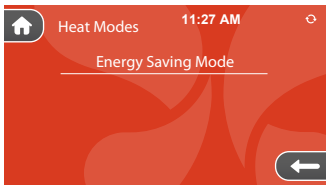

Figure 1

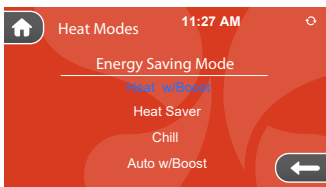

Figure 2

Set the Time of day you want to shut the heater off.

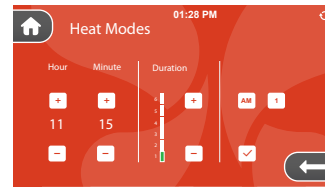

Figure 3

1. Set the hour and minute of the day by pressing the + or - button under Hour and Minute.
2. Press the AM or PM (when clock is set up for 12 hour time).
3. Set the Duration from 1 - 6 hours by pressing the + or - button under Duration.
4. Press the button to activate setting 1 and turn button green Figure 4. You can deactivate the setting by pressing the button.
5. Press the icon to go to the Home screen or to go back to last screen. **NOTE:** If a second setting is desired, press the 1 button to go to a second screen with a 2 on the button.

Repeat steps 1 - 4 above if a second time of day and duration set up is required.

NOTE: When selecting a second time of day the time and duration it CANNOT overlap with the first time of day and duration.

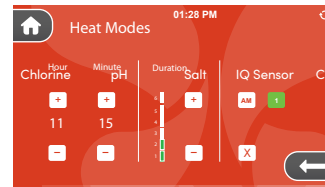

Figure 4

JETS CONTROL SCREEN

Press on the Home screen to display the Jets screen.



NOTE: If jets are off when is pressed on the Home screen, low speed for jet pump 2 will turn on. Your screen may look different depending on how many jet pumps your spa has.

The Jet pump icon (on home page) will remain displayed until a button is pressed to turn off the jet pump(s), or after one hour of continuous operation when the pump(s) is automatically shut off by the control system.

The jet pump(s) will turn themselves off after one hour of continuous operation to prevent overheating and conserve energy. The jets can be restarted again with no delay.



Press to turn Jet pump off.



Press to turn Jet pump on low speed.



Press to turn Jet pump on high speed.



Press to turn ALL jet pumps off (if on) or all to High speed (if off).

FRESHWATER IQ SMART MONITORING SYSTEM

SALT SYSTEM

Press  on the Home Screen to display the Water Care screen.

This icon will display on the Home screen if the spa has the **FRESHWATER** Salt System Cartridge installed. The Salt System screen will only display first when the **FRESHWATER** Smart Monitoring System Controller/Sensor has not yet been installed.

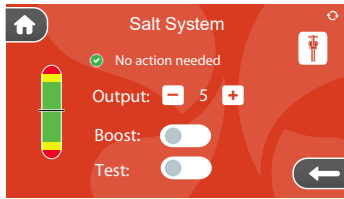

IMPORTANT: The Salt System must be installed first during the original setup and be fully functional before using the **FRESHWATER** Smart Monitoring System. This can be done by either waiting to install the Smart Monitoring IQ Sensor for a couple of days or installing the system and going to the IQ Sensor screen and turning the System Off for a couple of days.

See **FRESHWATER** Salt System Owner's Manual for more information.

SMART MONITORING SYSTEM

Press  on the Home screen to access Smart Monitoring System screen when IQ Sensor is installed. This water testing system works with the Salt system and measures pH, chlorine, and salt levels in the spa water. See **FRESHWATER** IQ Smart Monitoring System Manual on **CALDERA** website for more information.

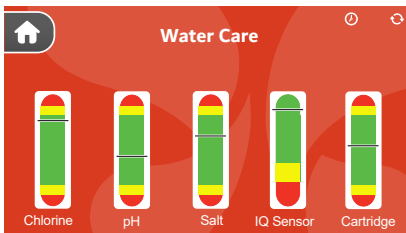

Press any of the 5 indicators to enter a secondary screen specific to the description below the indicator:

Indicators colors:

Green = Good, nothing to do.

Yellow = Caution, check to see if any action is currently required.

Red = Change is required, check for required action.

NOTE: Salt System must be installed and functional for Smart Monitoring System to work. If Smart Monitoring System instructions are not followed correctly the system will give your false readings.

FLIP SCREEN

Press  button to flip the screen for easy viewing and operation when inside the spa. Press a second time to reverse.

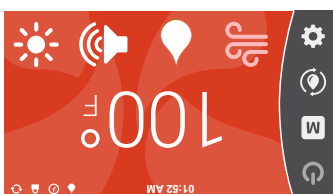

MUSIC SYSTEM SCREEN (OPTIONAL)

Press  on the Home screen to access the Music System screen.

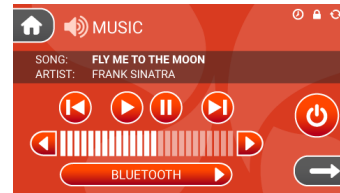

The Music icon will only display on the Home screen if your spa has the Music System installed.

 Press to turn the Music system ON or OFF.



The primary Music screen will display a music player with volume control and a Music Source selection box.

NOTE: When the Music system is turned Off there is an 8 second delay before Music system may be turned back ON.



The player functions consist of Track Down, Play, Pause and Track Up



Press  or  to decrease or increase the volume.



Press icon to display the Select Music Source screen.

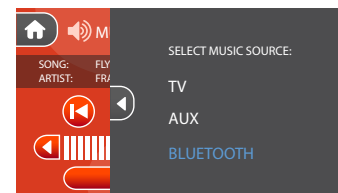

Press on the new desired Music source.

TV This source requires a spa TV only available from your **CALDERA** dealer.

AUX Source from a line level audio input

BLUETOOTH This source will work with any Bluetooth device. On your device go to Bluetooth settings and find either *My Spa Music* or *My Spa BTXR*.
(see pairing information on next page).



Press to return to Primary Music screen. Screen will automatically revert back after 10 seconds of non activity.

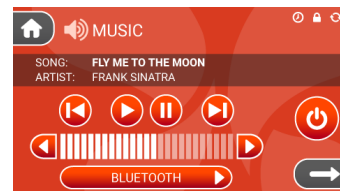

IMPORTANT: When using the Bluetooth source, the player functions may or may not work depending on your Bluetooth device. Not all Bluetooth devices will respond to player functions. Volume control will work on all audio sources.

➡ Press to advance to Secondary Music screen.

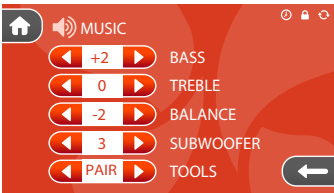

Press ◀ or ▶ to decrease or increase the value for each music feature. Bass, Treble and Balance range is from -5 to +5.

Subwoofer range is from 0 to 11.

Press ▶ in Tools to scroll between PAIR, SIGNAL and RESET, press ◀ in Tools to activate the current function.

To PAIR your device:

On your device go to Bluetooth settings and find either *My Spa Music* or *My Spa BTXR*.

My Spa Music: Press My Spa Music using the standard pairing method on your mobile device. Enter pairing number 0000 if needed.

My Spa BTXR:

Press ◀ with PAIR displayed inside TOOLS box followed by pressing "connect" next to *My Spa BTXR* on your device to pair. If you do not see this, another device may already be connected (see RESET below To Disconnect another Bluetooth device).

After pairing, you will be ready to use your Bluetooth device. Only one paired Bluetooth device will work at a time.

Use RESET to disconnect any device using the spa music system so that another paired device may be used. This is also necessary when trying to pair multiple devices because pairing is NOT possible when another device is connected to the music system.

- Press ◀ with RESET displayed inside TOOLS box to remove any device connected to the music system.

To view the signal strength between your Bluetooth device and the music system Press ◀ with SIGNAL displayed inside TOOLS box.



LIGHTS CONTROL SCREEN

Press ☀ on the Home screen to access the primary Lights screen.

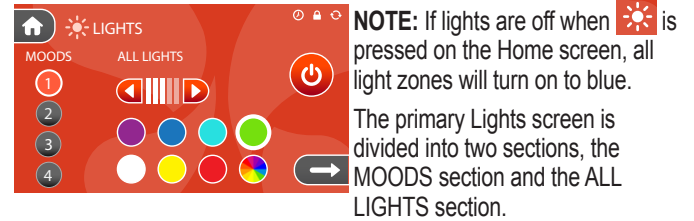

MOODS (Preset colors and brightness):

- 1 Press to turn On Underwater lights (blue color).
- 2 Press to turn On Underwater (magenta), Topside & Waterfall (aqua) and Exterior light (white).
- 3 Press to turn On Underwater & Topside lights (aqua).
- 4 Press to turn On Topside lights (white).

ALL LIGHTS:

- Press to turn all lights On or Off. When all lights are turned On they will all be blue.
- Press ◀ or ▶ to decrease or increase the brightness setting for all lights that are currently on.
- Press any of the color boxes to turn that color on in all light zones.
- Press the multicolored box to turn color wheel on for all light zones. Press the color wheel a second time to stop the color wheel at a desired color.
- Press to advance to the secondary Lights screen.

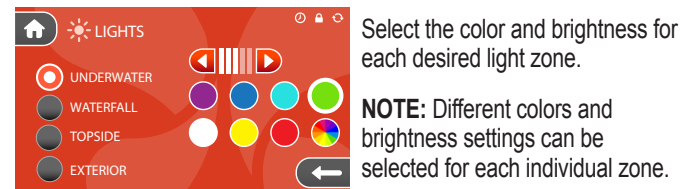

- Press the button next to the zone description to select the desired lighting zone (only one light zone can be selected at a time).
- Press ◀ or ▶ to decrease or increase the brightness setting for selected light zone.
- Press any of the color boxes to turn that color on in the selected light zone.
- Press the multicolored box to turn color wheel on for selected light zone. If more than one zone uses the color wheel, the colors will automatically synchronize. Press the color wheel a second time to stop the color wheel at a desired color.

AUXILIARY PANEL

AUXILIARY CONTROL PANEL BUTTONS

The auxiliary control panel, conveniently located opposite the main control panel allows the user to activate the jets and lights.

GENEVA, NIAGARA, TAHITIAN, FLORENCE & RAVELLO

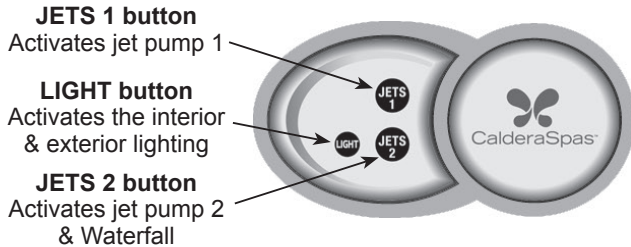

CANTABRIA

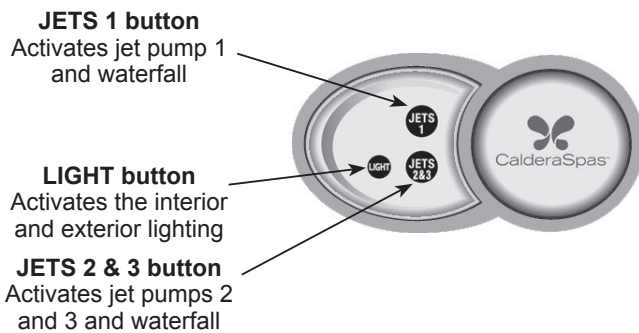

JETS BUTTON

There are two buttons which affect the jet pumps. Pressing any JETS button once displays the jets symbol on the main control panel display. The symbol will remain displayed until the jet pump is turned off (see chart below), or after one hour of continuous operation when the pumps are automatically shut off by the control system.

GENEVA, NIAGARA, TAHITIAN, FLORENCE & RAVELLO models:		
	JETS 1 button	JETS 2 button
1st press:	pump 1 on	pump 2 on low speed
2nd press:	pump 1 off	pump 2 on high speed
3rd press:	N/A	pump 2 off

CANTABRIA model:		
	JETS 1 button	JETS 2&3 button
1st press:	pump 1 on low speed	pump 2 on low speed
2nd press:	pump 1 on high speed	pump 2 on high speed
3rd press:	pump 1 off	pump 2 & 3 on high speed
4th press:	N/A	pump 2 on low & pump 3 on high speed
5th press:	N/A	pump 2 off & pump 3 on high speed
6th press:	N/A	pump 2 & 3 off

LIGHT BUTTON

The "LIGHT" button activates the SPAGLO multi-zone lighting system and controls the intensity of the light. Pressing the "LIGHT" button operates the light as follows:

- 1st press of the "LIGHT" button: all lights on.
- 2nd press: topside lights off.
- 3rd press: waterfall light off.
- 4th press: Underwater lights and EUPHORIA Jets lights on medium intensity; external lights on full intensity.
- 5th press: Underwater lights and EUPHORIA Jets lights on low intensity external lights on full intensity.
- 6th press: Underwater lights and EUPHORIA Jets lights off external lights on full intensity.
- 7th press: all lights off.

If any lights are left on, they will automatically be turned off by the control system after six hours of continuous operation. The light icon on the control panel will also turn off when the lights are deactivated.

If the light will not turn on, make sure SPA LOCK is deactivated. SPA LOCK disables the controls on both the main and auxiliary control panel. (See the SPA LOCK section for more information on the SPA LOCK feature.)

CANTABRIA ULTRAMASSEUSE CONTROL PANEL

The UltraMasseuse system turns on automatically in the UltraMasseuse lounge when jet pump 3 is activated. At this time, all the jets are on, and only the Speed indicator light is on. Pressing the Sequences button begins the jet massage sequences button. See Sequences on next page.

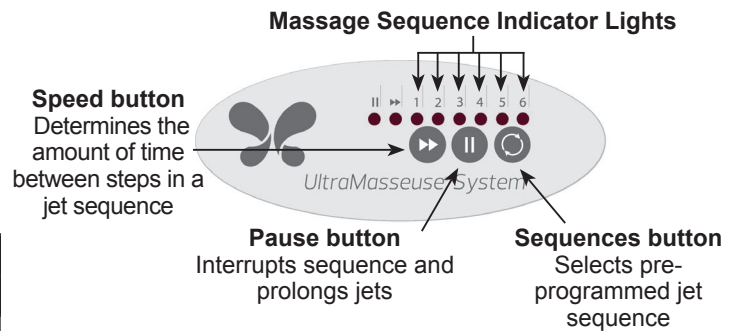

SEQUENCES BUTTON



The Sequences button controls the jet massage pattern.

The **ULTRAMASSEUSE** system is pre-programmed with six different jet sequences. Pressing the "Sequences" button once starts the first jet sequence. The corresponding indicator light will stay lit while the sequence is on.

To scroll through the jet sequences, keep pressing the Sequences button within 5 seconds. To select a jet sequence, scroll through until you have found the one you want, and then release the Sequences button.

Steps	Sequence 1	Sequence 2	Sequence 3	Sequence 4	Sequence 5	Sequence 6
Step 1	Neck and Upper Back Jets Lower Back and Feet Jets	Lower Back and Feet Jets Leg Jets	Neck and Upper Back Jets Leg Jets	Neck and Upper Back Jets	Neck and Upper Back Jets	Neck and Upper Back Jets
Step 2	Lower Back and Feet Jets	Neck and Upper Back Jet Leg Jets	Lower Back and Feet Jets	Neck and Upper Back Jets Lower Back and Feet Jets	All Jets	Lower Back and Feet Jets
Step 3	Leg Jets	Neck and Upper Back Jet Lower Back and Feet Jets	Neck and Upper Back Jets Leg Jets	Lower Back and Feet Jets Leg Jets	All Jets	Leg Jets
Step 4	Repeat Steps 1-3	Neck and Upper Back Jets Lower Back and Feet Jets	Lower Back and Feet Jets	Leg Jets	All Jets	Leg Jets
Step 5		Neck and Upper Back Jet Leg Jets	Neck and Upper Back Jets Lower Back and Feet Jets	Leg Jets	Neck and Upper Back Jets Lower Back and Feet Jets	Lower Back and Feet Jets
Step 6		Lower Back and Feet Jets Leg Jets	Leg Jets	Lower Back and Feet Jets Leg Jets	Neck and Upper Back Jets	Neck and Upper Back Jets
Step 7		Repeat Steps 1-6	Neck and Upper Back Jets Lower Back and Feet Jets	Neck and Upper Back Jets Lower Back and Feet Jets	Repeat Steps 1-6	Repeat Steps 1-6
Step 8			Neck and Upper Back Jets Lower Back and Feet Jets	Neck and Upper Back Jets		
Step 9			Lower Back and Feet Jets Leg Jets	Repeat Steps 1-8		
Step 10			Neck and Upper Back Jets			
Step 11			Lower Back and Feet Jets Leg Jets			
Step 12			Neck and Upper Back Jets			

SPEED BUTTON

The Speed button determines the amount of time between steps in a jet sequence. This button only functions when you have selected a sequence. The Speed indicator light corresponds to the speed chosen.

Press once: 15 seconds between each step (indicator light blinks slowly)

Press twice: 10 seconds between each step (indicator light blinks at medium speed)

Press a third time: 5 seconds between each step (indicator light blinks fast)

PAUSE BUTTON

The Pause button will interrupt the jet sequence and prolong the current jet massage.

Press once to pause the pre-programmed jet sequence and continue the current jet activity. The indicator light will be lit when the sequence is paused.

Press a second time to continue the jet sequence.

JET MENU

CANTABRIA JET SYSTEM MENU

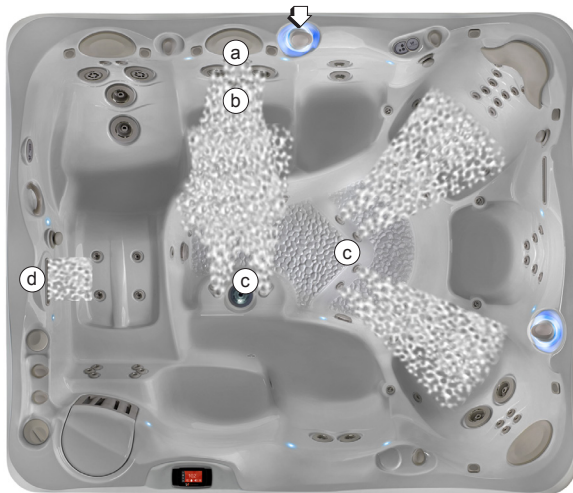

JET PUMP 1 - JET SYSTEM 1

- a. 2 Euro-Directional jets c. 10 Euro-Directional jets
- b. 3 **VERSASSAGE** jets d. 1 **ACQUARELLA** Waterfall

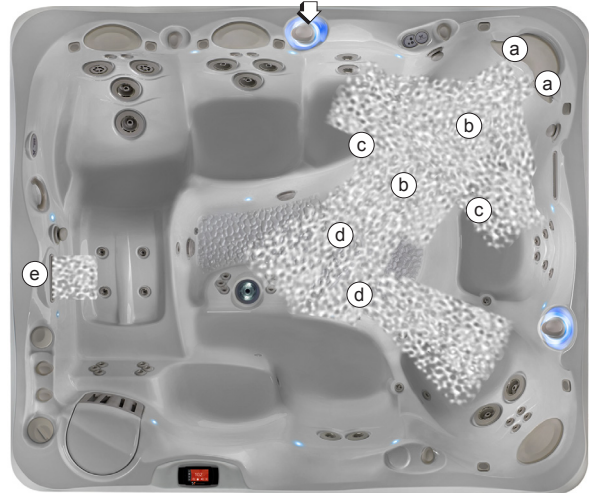

JET PUMP 1 - JET SYSTEM 2

- a. 2 Directional Neck jets d. 4 Euro-Directional jets
- b. 16 Euro-Directional jets e. 1 **ACQUARELLA** Waterfall
- c. 2 **EURO-PULSE** jets

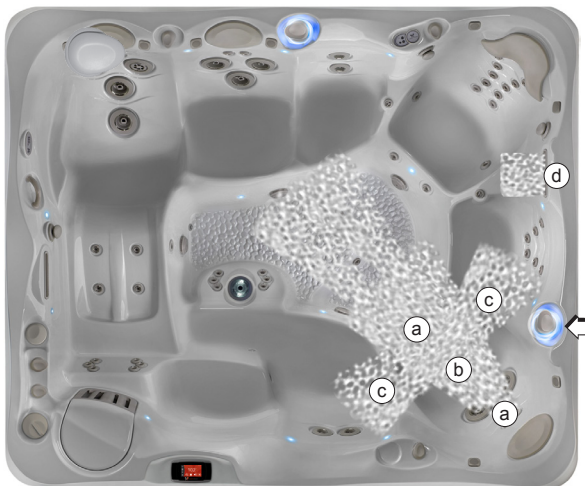

JET PUMP 2 - JET SYSTEM 1

- a. 8 Euro-Directional jets c. 2 **EURO-PULSE** jets
- b. 2 **VERSASSAGE** jets d. 1 **ACQUARELLA** Waterfall

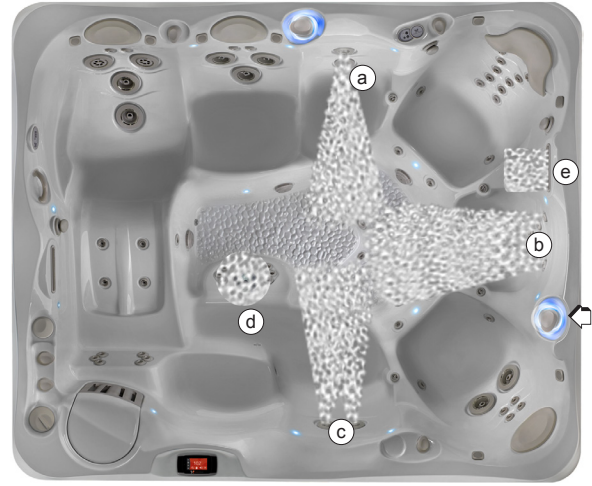

JET PUMP 2 - JET SYSTEM 2

- a. 2 **ADAPTASSAGE** jets d. 1 **EUPHORIA** jet
- b. 6 Euro-Directional jets e. 1 **ACQUARELLA** Waterfall
- c. 2 **ADAPTASSAGE** jets

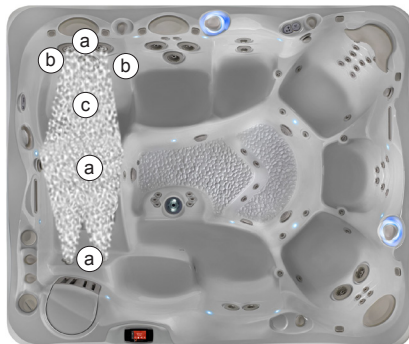

JET PUMP 3 - ULTRAMASSEUSE SYSTEM

Located in the UltraMassage® lounge:

- a. 12 Euro-Directional jets
- b. 2 **ORBISSAGE** jets
- c. 2 **VERSASSAGE** jets

☒ = position of diverter valve to control jet system

GENEVA JET SYSTEM MENU



JET PUMP 1 – JET SYSTEM 1

Located in EcstaSeat®

- a. 2 Directional Neck jets
- b. 18 Euro Directional jets
- c. 2 EURO-PULSE jets



JET PUMP 1 – JET SYSTEM 2

Located in ECSTASEAT

- a. 2 ADAPTASSAGE jets
- b. 1 ADAPTAFLO jet
- c. 1 EUPHORIA jet
- d. 2 Directional Neck jets
- e. 2 Euro Directional jets



JET PUMP 1 – JET SYSTEM 2

Located in LumbarSsage® seat

- a. 2 ADAPTASSAGE jets
- b. 8 Euro Directional jets
- c. 2 VERSASSAGE jets
- d. 1 ADAPTAFLO jet



JET PUMP 2 – JET SYSTEM 1

Located in ULTRAMASSAGE lounge:

- a. 2 VERSASSAGE jets
- b. 2 ORBISSAGE jets
- c. 6 Euro Directional jets
- d. 6 Sole Soothers® jet
- e. ACQUARELLA Waterfall

⇄ = position of diverter valve to control jet system



JET PUMP 2 – JET SYSTEM 2

Located in ULTRAMASSAGE lounge:

- a. 2 VERSASSAGE jets
- b. 2 ORBISSAGE jets
- c. 2 Euro Directional jets
- d. 2 ADAPTASSAGE jets
- e. 1 EUPHORIA jet
- f. ACQUARELLA Waterfall

COMBINATION JET SYSTEM

Jet Pump diverter in mid position activates both Jet Pump Systems 1 and 2.
Right Side diverter in mid position activates both Right Side Systems

NIAGARA JET SYSTEM MENU



JET PUMP 1 – JET SYSTEM 1

- a. 2 **VERSASSAGE** jets
- b. 4 Euro Directional jets
- c. 1 **EUPHORIA** jet

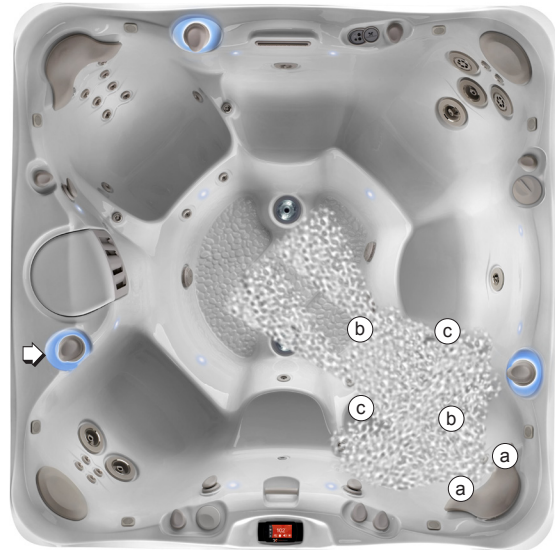

JET PUMP 1 – JET SYSTEM 2

Located in **ECSTASEAT**

- a. 2 Directional Neck jets
- b. 14 Euro Directional jets
- c. 2 **EURO-PULSE** jets

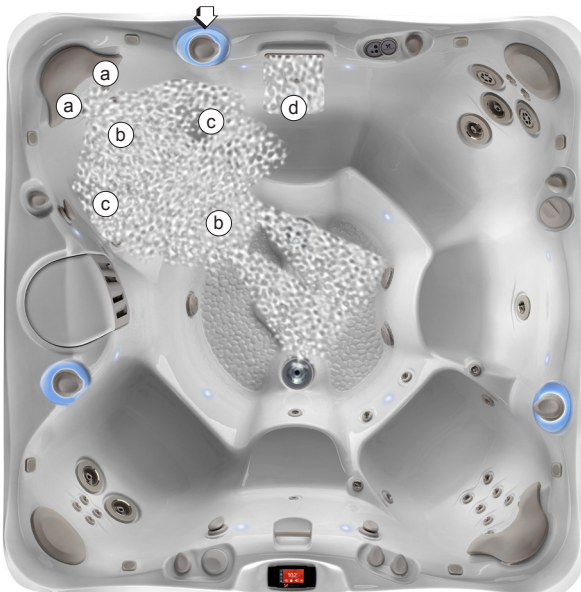

JET PUMP 2 – JET SYSTEM 1

Located in **ECSTASEAT**

- a. 2 Directional Neck jets
- b. 14 Euro Directional jets
- c. 2 **EURO-PULSE** jets
- d. **ACQUARELLA** Waterfall

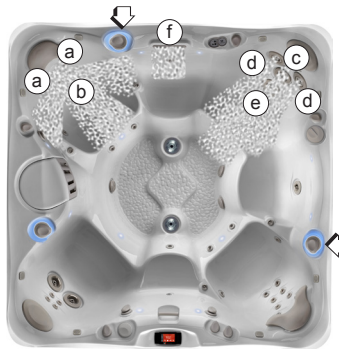

JET PUMP 2 – JET SYSTEM 2 + SYSTEM 1

Located in **ECSTASEAT**

- a. 2 Directional Neck jets
- b. 2 Euro Directional jets
- c. 2 Euro Directional jets
- d. 2 **ORBISSAGE** jets
- e. 2 **VERSASSAGE** jets
- f. **ACQUARELLA** Waterfall

Located in **ULTRAMASSAGE** seat

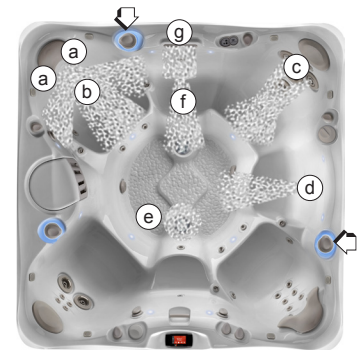

JET PUMP 2 – JET SYSTEM 2 + SYSTEM 1

Located in **ECSTASEAT**

- a. 2 Directional Neck jets
- b. 2 Euro Directional jets
- c. 2 **ORBISSAGE** jets
- d. 1 **ADAPTAFL0** jet
- e. 1 **EUPHORIA** jet
- f. 1 **ADAPTAFL0** jet
- g. **ACQUARELLA** Waterfall

Located in **ULTRAMASSAGE** seat

⏏ = position of diverter valve to control jet system

COMBINATION JET SYSTEM

Jet Pump diverter in mid position activates both Jet Pump Systems 1 and 2.
Right Side diverter in mid position activates both Right Side Systems

TAHITIAN JET SYSTEM MENU



JET PUMP 1 – JET SYSTEM 1

Located in **ECSTASEAT**

- a. 2 Directional Neck jets
- b. 14 Euro Directional jets



JET PUMP 1 – JET SYSTEM 2

- a. 2 Euro Directional jets
- b. 1 ADAPTAFLO jet
- c. 2 VERSASSAGE jets
- d. 6 Euro Directional jets
- e. 1 ADAPTAFLO jet

Located in **LUMBARSSAGE** seat



JET PUMP 1 – JET SYSTEM 2

- a. 2 Euro Directional jets
- b. 1 ADAPTAFLO jet
- c. 1 ADAPTAFLO jet
- d. 1 EUPHORIA jet



JET PUMP 2 – JET SYSTEM 1

Located in **ULTRAMASSAGE** lounge

- a. 6 SOLE SOOTHERS
- b. 6 Euro Directional jets
- c. 2 VERSASSAGE jets
- d. 2 ORBISSAGE jets
- e. ACQUARELLA Waterfall

☰ = position of diverter valve to control jet system



JET PUMP 2 – JET SYSTEM 2

Located in **ULTRAMASSAGE** lounge

- a. 2 Euro Directional jets
- b. 2 VERSASSAGE jets
- c. 2 ORBISSAGE jets
- d. 2 ADAPTASSAGE jets
- e. 1 EUPHORIA jet
- f. ACQUARELLA Waterfall

COMBINATION JET SYSTEM

Jet Pump diverter in mid position activates both Jet Pump Systems 1 and 2.
Right Side diverter in mid position activates both Right Side Systems

FLORENCE JET SYSTEM MENU

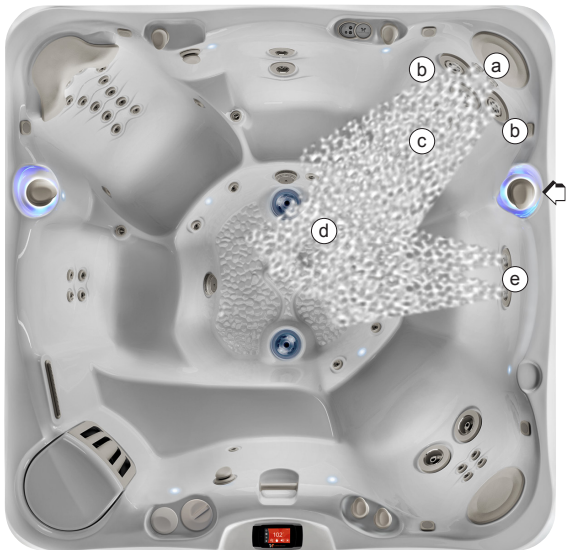

JET PUMP 1 – JET SYSTEM 1

Located in **LUMBARSSAGE** seat

- a. 2 Euro Directional jets
- b. 2 **ORBISSAGE** jets
- c. 2 **VERSASSAGE** jets
- d. 2 Euro Directional jets
- e. 2 **ADAPTASSAGE** jets



JET PUMP 1 – JET SYSTEM 2

Located in **ECSTASEAT**

- a. 1 **EUPHORIA** jet
- b. 2 **ADAPTASSAGE** jets
- c. 2 **VERSASSAGE** jets
- d. 4 Euro Directional jets
- e. 2 Euro Directional jets



JET PUMP 2 – JET SYSTEM 1

Located in **ECSTASEAT**

- a. 2 Directional Neck jets
- b. 14 Euro Directional jets
- c. 2 Euro Directional jets
- d. 2 **EURO-PULSE** jets
- e. **ACQUARELLA** Waterfall
- f. 4 Euro Directional jets

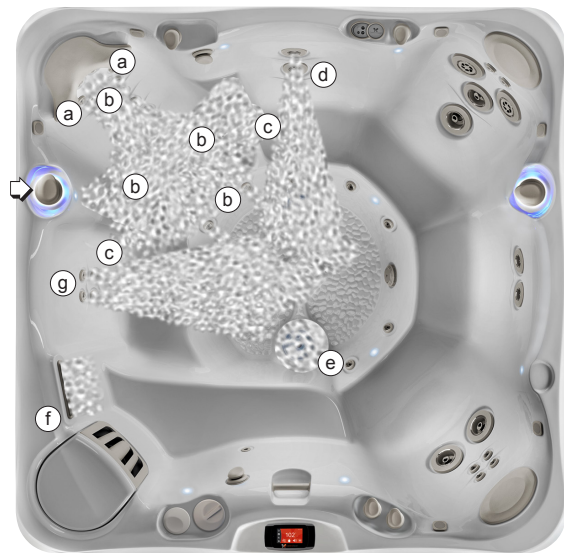

JET PUMP 2 – JET SYSTEM 2

Located in **ECSTASEAT**

- a. 2 Directional Neck jets
- b. 6 Euro Directional jets
- c. 2 **EURO-PULSE** jets
- d. 2 **ADAPTASSAGE** jets
- e. 1 **EUPHORIA** jet
- f. **ACQUARELLA** Waterfall
- g. 4 Euro Directional jets

🏠 = position of diverter valve
to control jet system

COMBINATION JET SYSTEM

Jet Pump diverter in mid position activates both Jet Pump Systems 1 and 2.

RAVELLO JET SYSTEM MENU

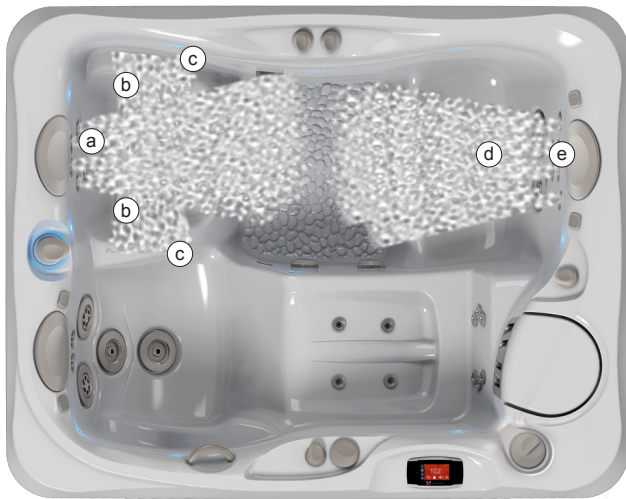

JET PUMP 1 – JET SYSTEM

Located in **ECSTASEAT**:

- a. 8 Euro Directional jets
- b. 2 Euro Directional jets
- c. 2 Euro-Pulse jets

Located in **LUMBARSSAGE** seat:

- d. 2 **VERSASSAGE** jets
- e. 6 Euro Directional jets



JET PUMP 2 – JET SYSTEM 1

Located in **ULTRAMASSAGE** lounge:

- a. 6 Euro Directional jets
- b. 4 Euro Directional jets
- c. 2 **VERSASSAGE** jets
- d. 2 **ORBISSAGE** jets
- e. 2 Euro Directional jets

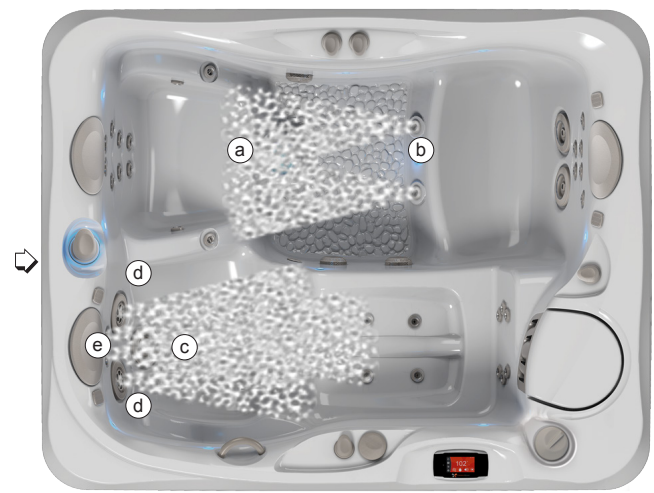

JET PUMP 2 – JET SYSTEM 2

- a. 1 Eurphoria jet
- b. 2 Euro Directional jets

Located in **ULTRAMASSAGE** lounge:

- c. 2 **VERSASSAGE** jets
- d. 2 **ORBISSAGE** jets
- e. 2 Euro Directional jets

↕ = position of diverter valve
to control jet system

COMBINATION JET SYSTEM

Jet Pump diverter in mid position activates Jet Pump 2 Systems 1 and 2.

SPA CARE AND MAINTENANCE

Your **CALDERA** spa is manufactured from the highest quality, most durable materials available. Even so, the spa care and maintenance program you develop will ultimately determine how long your spa, and its individual components, will last. Regular maintenance and following the advice in this section will help you to protect your investment.

FILTER MAINTENANCE

At least once a week, check and clean the skimmer basket and weir to ensure proper filter flow. Remove leaves, foreign matter, and debris. It is very important to keep your spa filter cartridge clean and free of particles to ensure proper water flow. A clean filter enables the hydrotherapy system to function properly and allows for more efficient filter cycles. Depending on how frequently your spa is used, we recommend cleaning the spa filter cartridge every four weeks. If this is not done, the filter may clog and restrict water flow, which causes improper filtration, poor jet performance and may possibly freeze.

IMPORTANT: The frequency and duration of use, and the number of occupants all contribute to determining the appropriate time between filter cleanings. More use means that more frequent filter cleanings will be required.

FILTER CARTRIDGE REMOVAL AND CLEANING INSTRUCTIONS

Turn the power to the spa off, then proceed as follows:

Push down slightly and turn filter basket counter-clockwise to unlock, then pull out the basket and floating weir.

Carefully pull up the filter cartridge and bring it out of the spa.

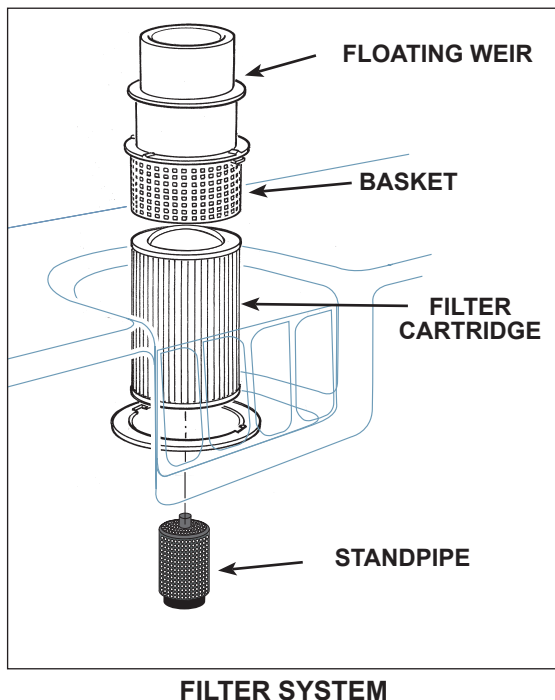

Always clean the filter using a filter degreaser to remove mineral and oil build-up. Simply soak the filter in the degreaser (according to the package directions), then place the filter on a clean surface and spray until clean using a garden hose. It may be necessary to rotate the filter while spraying to remove any debris lodged between the filter pleats. Re-insert filter cartridge.

To return basket and floating weir, insert and rotate clockwise to lock into position. Then turn spa's power back on.

NOTE: Replacement filter cartridges are available from your **CALDERA** dealer. Refer to the back of this manual to determine the appropriate size for your spa.

DIVERTER VALVE MAINTENANCE

If your spa's diverter valves become difficult to turn, it is likely that sand or grit is lodged inside the valve body. It is very important that this debris is removed as soon as possible to avoid damage to the valve. To clean the valves, follow these steps:

1. Turn off power to the spa by tripping both GFCI breakers located in the subpanel.
2. Unscrew the cap ring to remove the diverter valve's handle as cap ring comes upward.
3. Remove the valve body by pulling it upward.
4. Wipe the valve body and the interior walls of the valve clean.
5. Lubricate the o-rings with a waterproof lubricant available from your **CALDERA** dealer.
6. Reassemble the valve and turn power to the spa on.

VERSASSAGE JET MAINTENANCE

If you notice that the **VERSASSAGE** jet spins slower than when the spa was new, or the jets are sticking, the cause may be built-up deposits inside the jet bearings. To remove the deposits, use the following instructions:

1. With the spa off, rotate the **VERSASSAGE** jet face counter-clockwise until it stops.
2. Once the face stops rotating, use a little extra force to rotate the face even more counter-clockwise past the locking position until it stops. Pull face with the body away from the spa.
3. After flushing the bearing inside the body with water, spin the rotating eye. It should spin very freely. If it does not, place the bearing end in a cup of vinegar (the vinegar will soften any deposits). Allow it to soak overnight. The next day, flush with water and repeat the spin test.

NOTE: If the jets still don't spin freely, a second night of soaking maybe required. If the bearing still does not spin, you will need to purchase a replacement assembly from your **CALDERA** dealer.

COLD WATER REFILL

- When refilling your spa if the tap water is below 50° F (10° C) the spa may go into a High Limit Protection mode (causing your spa to stop functioning). If high limit tripping does occur, the fastest way to reactivate the spa control system is to first disconnect power to the spa completely, then warm the two sensors on top of the heater and the vinyl tubing (located in the equipment compartment) with a hair dryer for approximately 10 minutes. Once you believe the sensors and heater tubing have been warmed sufficiently, reconnect power to the spa.
- Blending warm water with the cold tap water so it exceeds 50° F (10° C) during the refilling process will also achieve the same results if that is an option for you.

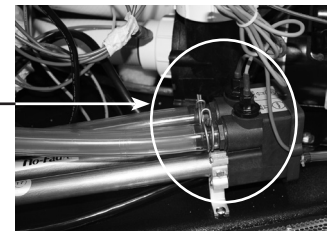

DRAINING YOUR SPA

1. Turn off all GFCI breakers in sub-panel, or main electrical panel.

2. Locate the main drain valve (bottom front) for the spa. Pull on handle (Figure 1, pliers may be used to pull handle) until you reach the mid position then rotate handle slightly to fully extended drain tube (drain cap and 1" of the drain tube is exposed) (Figure 2) then remove the drain cap (Figure 3).

NOTE: Do not remove drain cap in mid position. Attach the garden hose to the end of the drain (to avoid flooding of the foundation surrounding the spa) making sure not to push the drain tube inward. Route the outlet of the hose to an appropriate draining area.

NOTE: Spa water with a high sanitizer level may harm plants and grass.

3. Push the garden hose and drain tube half-way back towards the spa (Figure 4) which will start the gravitational flow. Drain tube must be in the mid position for the spa to drain.

IMPORTANT: All models will drain almost completely through the drain valve. Equipment such as the jet pump and heating system may not completely drain. Any water remaining within the plumbing or equipment after draining will only need to be removed if the spa is being winterized.

4. After your spa is empty, clean the shell and filter cartridge.

5. Pull and remove garden hose, replace drain cap and push drain tube back into spa as seen in Figure 1.

6. Follow the "START-UP PROCEDURES" to refill your spa.

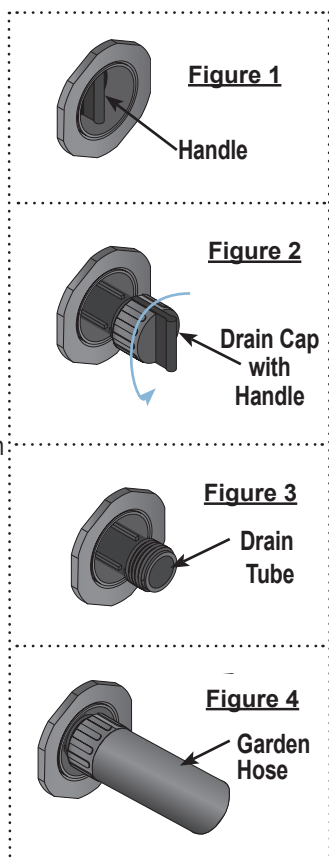

PREVENTION OF FREEZING

Your spa has been designed and engineered for year-round use in any climate. In some areas, extremely cold temperatures (below 10°F) combined with strong wind, may cause partial freezing of the jet pump, even though the water inside the spa remains at the selected temperature. The energy efficiency of the spa may also decrease during these cold periods, as the heater will cycle more frequently. As an additional precaution against partial freezing of some of the components, the equipment compartment can be insulated with an insulating kit (P/N 31399) available from your local dealer. This insulating kit will also help to maximize the spa's energy efficiency.

NOTE: When warmer weather returns (approx. 60°-70°F or 15°-21°C), the insulating kit must be removed to prevent overheating of the jet pump.

WINTERIZING YOUR SPA

If you leave the spa unused for a long period of time in severely cold weather, you should drain the spa and winterize it to avoid accidental freezing due to a power or equipment failure.

Use only Propylene Glycol as your anti-freeze (available at most RV or marine supply stores). This is non-toxic.

DANGER: Never use an automobile anti-freeze (Ethylene Glycol) since it is toxic!

WARNING: Failure to follow these instructions correctly can lead to freeze damage not covered by warranty. It is strongly recommended that you contact your local dealer to perform this service.

1. Drain your spa following the Draining Your Spa section in the owner's manual.

2. Remove the filter cartridge, clean and store in a dry place.

IMPORTANT: These additional instructions must be utilized when draining and winterizing your spa in climates where the temperature falls below 32°F (0°C). A five (5) gallon combination (vacuum/blower) wet/dry shop vac must be used to effectively remove water that is trapped inside the plumbing lines.

3. Attach the vacuum hose to the vacuum side of the shop vac. Vacuum all openings and orifices as follows:

- Jet openings: start with the jets at the top and move downward (if suction is coming from another jet, block off the other jet using a large rag – this will help pull out the water that is trapped deeper inside the main line).
- Filter suction fittings and filter compartment.
- Main drain outlet (it may be necessary to cover the drain grate tightly with a rag when vacuuming the main drain to ensure water is drawn completely from the internal plumbing system).

4. Thoroughly dry the spa shell with a clean towel.

5. Remove pump door first. Once door is removed unscrew the pump drain plugs located on the front of the pump housing. Allow all water to drain out. Place the drain plugs in a ziplock bag and store near the pumps. Replace the drain plugs on Start-up.

6. Unscrew the pump unions and allow the water to drain. Loosen and remove hose attached to circulation pump to allow any remaining water from heater and spa to drain out. Replace circulation pump hose once water is drained. **NOTE:** Tighten the pump unions prior to filling the spa.

7. Replace the main drain cap.

8. Using a long-extension funnel, pour anti-freeze into all standpipes, filter suction fittings, jet orifices and water feature orifices. Add enough anti-freeze to ensure adequate protection – in many cases, you will see the liquid in the orifice, or coming out of another location.

CAUTION: Use only Propylene Glycol as your anti-freeze. This is non-toxic. Never use an automobile anti-freeze (Ethylene Glycol) since it is toxic!

9. Close the spa cover and fasten the cover tie downs. Cover the spa cover with two pieces of plywood to evenly distribute the weight of snow and ice. Secure a plastic sheet, or tarp, over the spa cover and plywood.

10. Replace the equipment access door, if removed.

OPENING INSTRUCTIONS:

1. Remove plywood and plastic sheet. Open the spa cover by unfastening the cover tie downs.

2. Follow the Start-up Procedures in the Getting Started section of the Owner's Manual. Do not install filters to prevent them from exposure to the anti-freeze.

- As part of this process, superchlorinate the spa water by adding three teaspoons of chlorine (sodium dichlor) per 250 gallons (950 liters) of spa water into the filter compartment. This is twice the normal amount of chlorine needed for superchlorination. This extra amount of chlorine is needed to destroy the anti-freeze.
NOTE: A defoamer may be needed to decrease the amount of foam caused by the anti-freeze.
- Drain your spa to ensure removal of anti-freeze. Do not drain water on grass or plants due to excessive chlorine level.
- After the spa has completely drained, re-install your filter and follow the Start-up Procedures in the Getting Started section of the Owner's Manual.

IMPORTANT: Always keep spa covered when not in use, whether it is empty or full.

CARE OF THE SPA PILLOWS

The spa pillows will provide years of comfort if treated with care. They have been positioned above the water level to minimize the bleaching effects of chlorinated water and other spa water chemicals. To extend their life, whenever the spa shell is being cleaned, the spa pillows should be removed and cleaned. Body oils can be removed with a mild soap and water solution. ALWAYS rinse off the spa pillows thoroughly to remove any soap residue. If the spa is not going to be used for a long period of time (that is during a vacation or if the spa is winterized), or when the spa water is being super-chlorinated, the spa pillows should be removed until the next use of the spa.

TO REMOVE AND REPLACE THE SPA PILLOWS:

- Carefully lift one end of the pillow away from the spa shell.
- Continue lifting one end until all pillow retainers are released from the pillow.
IMPORTANT: Just pulling the pillow straight up and out of the shell recess will eventually damage the pillow. This abuse is not covered under warranty.
- To reinstall the spa pillow, carefully bend the pillow slightly to allow one of the pillow retainers to slip into the recess in the back of the pillow.
- Keeping the pillow slightly bent, slide the other pillow retainer into the recess in the back of the pillow.
- After all the pillow retainers are in place, press the pillow down into the recess in the spa shell.

CARE OF THE EXTERIOR

SPA SHELL

Your CALDERA spa has an acrylic shell. Stains and dirt generally will not adhere to your spa's surface. A soft rag or a nylon scrubber should easily remove most dirt. Most household chemicals are harmful to your spa's shell (see below for detailed information on cleaning agents). Always rinse off any spa shell cleaning agent with fresh water.

IMPORTANT:

- The following products are the ONLY approved cleaning agents for your CALDERA spa shell: plain water, Brillianize® or Soft Scrub®. The use of alcohol or any other household cleaner other than those listed to clean the spa shell surface is NOT recommended. DO NOT use any cleaning products containing abrasives or solvents since they may damage the shell surface, specifically: Simple Green®, Windex® or Spa Mitt. NEVER USE HARSH CHEMICALS! Damage to the shell by use of harsh chemicals is not covered under the

warranty. Always rinse off any spa shell cleaning agent with fresh water.

- Iron and copper in the water can stain the spa shell if allowed to go unchecked. Ask your CALDERA dealer about a Stain and Scale Inhibitor to use if your spa has a high concentration of dissolved minerals. (WATKINS WELLNESS recommends Stain & Scale Defense.)
- Keep all cleaners out of the reach of children and use care when applying.

ECOTECH® PLUS SPA CABINET

All Utopia spas use the exclusive all-climate ECOTECH PLUS Cabinet designed for years of performance. The unique, ribbed pattern design is enhanced by the rich cabinet colors that give the appearance of high-end furniture, without looking like real wood and, because of the durability of the spa cabinet material, it comes with a five year warranty against cracking, or rotting.

CARE OF THE SPA COVER

⚠️ WARNING: The cover is a manual safety cover that meets or exceeds all prevailing requirements of ASTM 1346-91 for spa safety covers when installed and used correctly as of the date of manufacture. Non-secured, or improperly secured covers are a hazard.

Open the cover to its fully open position before use.

COVER CARE

The cover is made with a solution dyed polyester fabric and is an attractive, durable foam insulation product. Monthly cleaning is recommended to maintain its beauty and a longer fabric life.

To clean and condition the polyester cover:

- Remove and gently lean against a wall or fence. If a cover lifter has been installed keep cover closed and make sure all seams are closed to prevent any soap from entering the spa.
- With a garden hose, spray the cover to loosen and rinse away dirt or debris.
- Add four tablespoons of mild soap or mild dishwashing liquid with one gallon (4 liters) of lukewarm water. Clean using a soft bristle brush. Rinse thoroughly with cold water and air dry. **IMPORTANT:** Do not let the polyester dry with a soap film on it before it can be rinsed clean.
- Scrub the cover's perimeter and side flaps. Rinse clean with water.
- Rinse off the underside of the cover with water only (use no soap), and wipe it clean with a dry rag.

IMPORTANT REMINDERS:

- DO** remove snow buildup to avoid breakage of the foam core from the additional weight of the snow.
- DO** lock cover lock straps to secure the cover when the spa is not in use.
- DO NOT** drag or lift the spa cover using either the flaps or the cover lock straps.
- DO NOT** walk, stand, or sit on the cover.
- DO NOT** place any metal or heat transferring object on the cover or place any type of plastic tarp or drop cloth over the cover as this may result in a melted foam core, which would not be covered under the warranty.
- DO NOT** use any lifting mechanisms, chemicals or cleaners except those recommended by WATKINS WELLNESS or its Authorized Sales and Service Dealer.

ELECTRICAL REQUIREMENTS

IMPORTANT: Fill the spa with water before turning on the power.

Your **CALDERA** spa has been carefully designed to give you maximum safety against electrical shock. Connecting the spa to an improperly wired circuit will negate many of the spa's safety features. Improper wiring may also cause electrocution, risk of fire, and other risks of injuries. Please read and follow the electrical installation requirements and instructions for your specific spa model completely!

All **CALDERA** spa models, are equipped with a power indicator (**CALDERA** Logo orange light) which, in addition to showing the spa has power to it, has a diagnostic function as well. It will begin blinking if the heater high-limit thermostat has tripped. If the power indicator light is blinking, follow the instructions in the Troubleshooting section to identify and correct the cause. The power indicator will stop blinking once the problem has been corrected. The Power and Ready indicator lights on the control panel also provide the same diagnostic function.

230 VOLT PERMANENTLY CONNECTED

CALDERA spas must be wired in accordance with all applicable local electrical codes. All electrical work should be done by an experienced, licensed electrician. We recommend the use of appropriate electrical conduit, fittings, and wire for all circuits.

The diagram on the following pages illustrates how to wire the spa models:

- An electrical subpanel containing two GFCI breakers is included with each 230 volt spa. We recommend that this subpanel be used to supply power to the spa.
- The subpanel requires a 50 amp, single phase, 230 volt, four wire service (two line, one neutral, one ground).

The grounding conductor must not be less than #10 AWG. Refer to local codes and to NEC 250-122 (table).

NOTE: The **CANTABRIA** will require an additional 20 amp breaker in order to operate the heater and the Lounge seat (jet pump 3) at the same time. Without the additional 20 amp breaker, the heater will **NOT** operate while the jets in the lounge (jet pump 3) are on.

- Mount the subpanel in the vicinity of the spa, but not closer than 5 feet (1.5 m) away, in accordance with all local codes. (N.E.C. 680-38 to 41-A-3)
- Open spa using Door Panel Removal instructions (page 35).
- Insert power wires into spa from either side towards the bottom front, you will find a plastic cap attached to spa.
- Once your spa has been filled with water, turn it on and test all of the circuit breakers.

IMPORTANT: If both breakers immediately trip, verify that the wires are correctly connected. Each breaker should be tested prior to each use. Here's how:

1. Push the "TEST" button on each GFCI breaker, and observe it click OFF.
2. Wait 30 seconds, then push the breaker switch to the OFF (down) position (to ensure that it has completely disengaged), then push the breaker switch to the ON (up) position. If you don't wait 30 seconds, the spa's power indicator may continue to blink – try again.

If any of the GFCI breakers fails to operate in this manner, your spa may have an electrical malfunction, and you may be at risk of electrical shock. Turn off all circuits and do not use the spa until the problem has been corrected by an authorized service agent.

⚠ WARNING: Removing, or bypassing any GFCI breaker will result in an unsafe spa and will void the spa's warranty.

EQUIPMENT COMPARTMENT

The illustration below is to be used as a reference only (your spa may look different). The equipment compartment is located behind the front panel of the spa below the Main Control Panel.

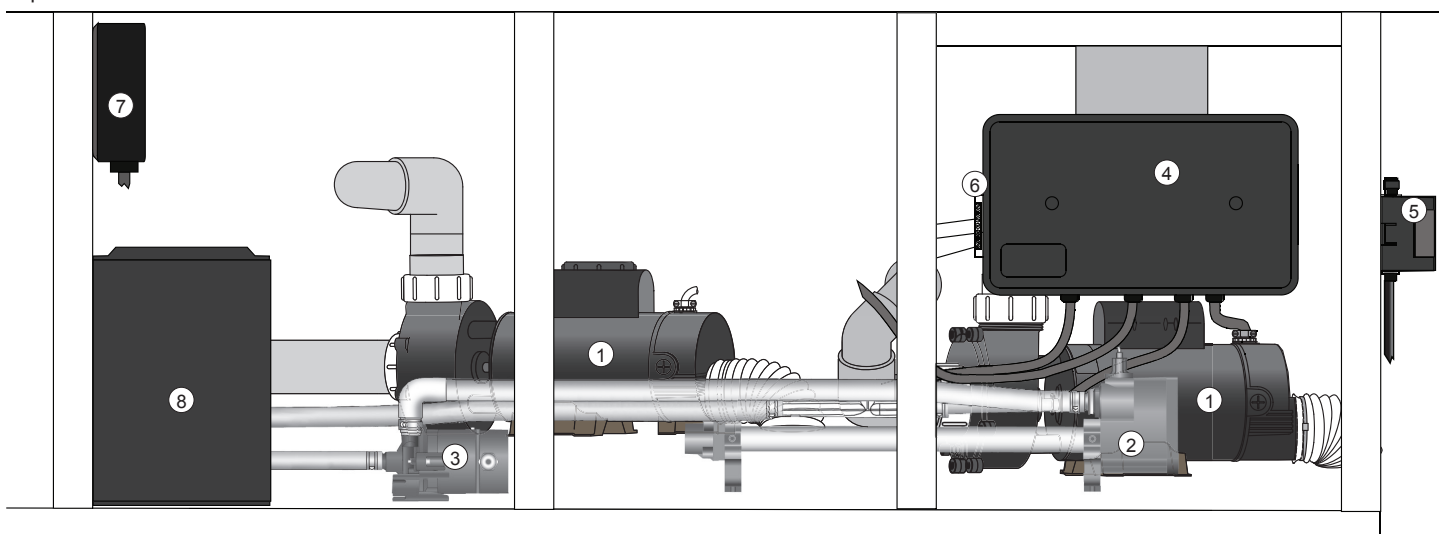

- | | |
|---------------------------------------|-------------------------------|
| 1. Jet pump* | 5. Ozone Generator (optional) |
| 2. EnergyPro® heater | 6. Bonding terminal |
| 3. ENERGY PRO Circulation Pump | 7. Bluetooth Music (optional) |
| 4. Advent® Control Box | 8. Subwoofer (optional) |

* There are 3 jet pumps located in the Cantabria equipment compartment, only 2 are shown in illustration above.

IMPORTANT: If you ever need to move or relocate your **CALDERA** spa, it is essential that you understand and apply these installation requirements. Your **CALDERA** spa has been carefully engineered to provide maximum safety against electric shock. Remember, connecting the spa to an improperly wired circuit will negate many of its safety features.

NOTE: Long wiring runs may require larger-gauge wire than stated.

ALL MODELS (EXCEPT CANTABRIA SEE BELOW)

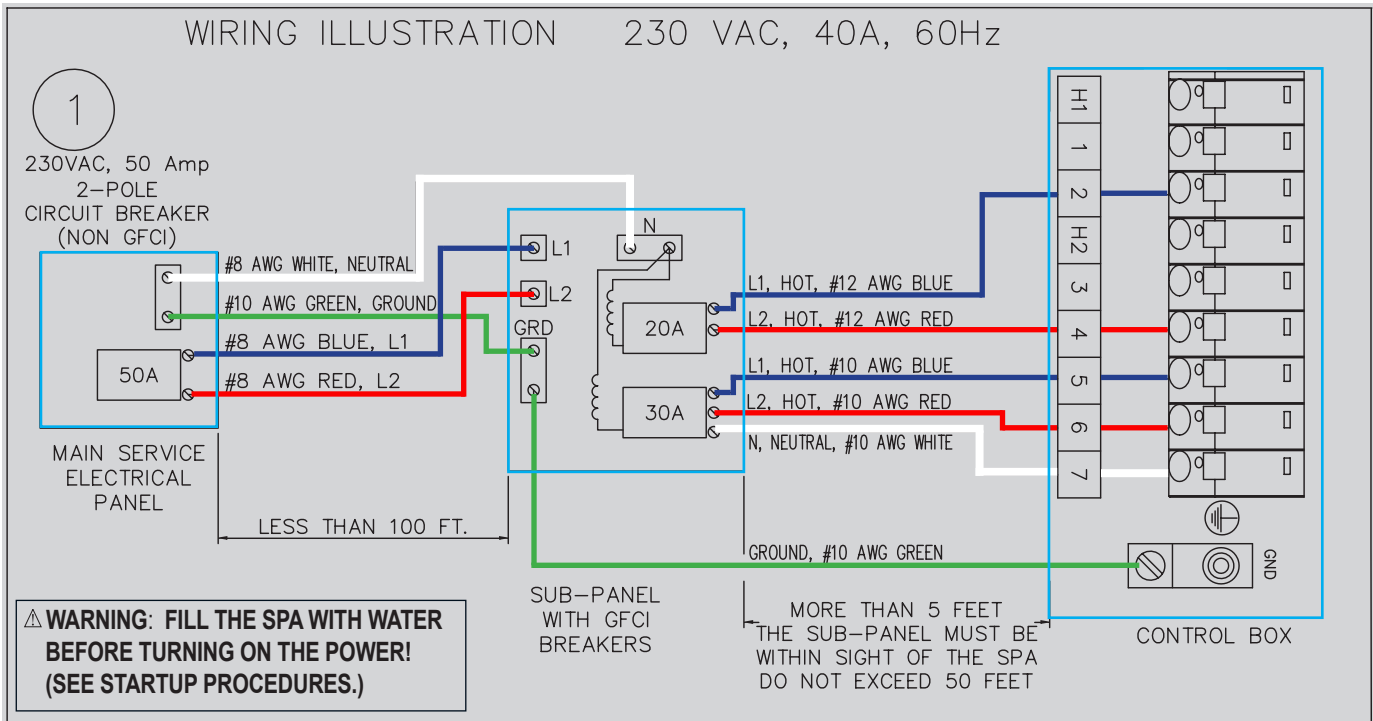

⚠ WARNING: Removing or bypassing any GFCI breaker will result in an unsafe spa and will void the spa's warranty.

CANTABRIA - STANDARD

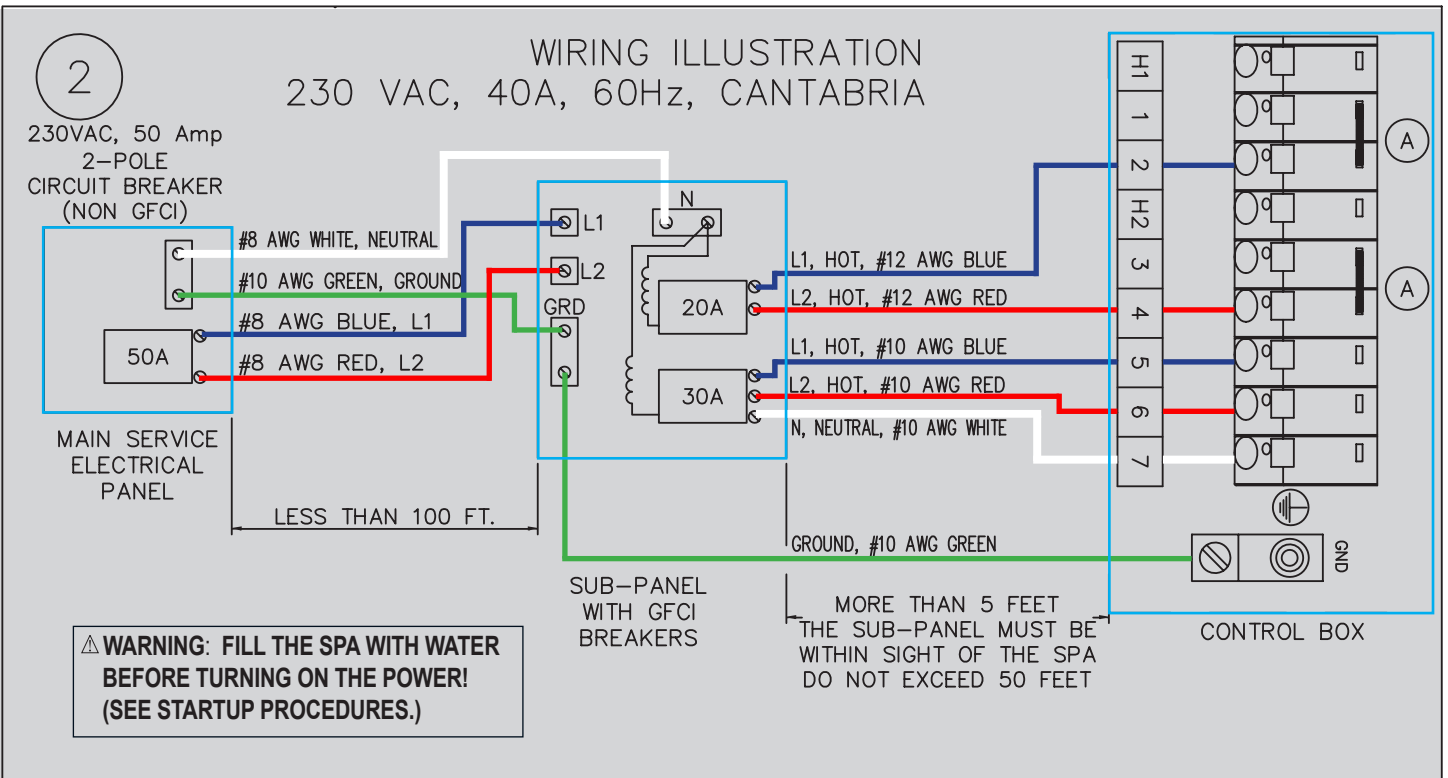

CANTABRIA - CONVERTED TO 70 AMP

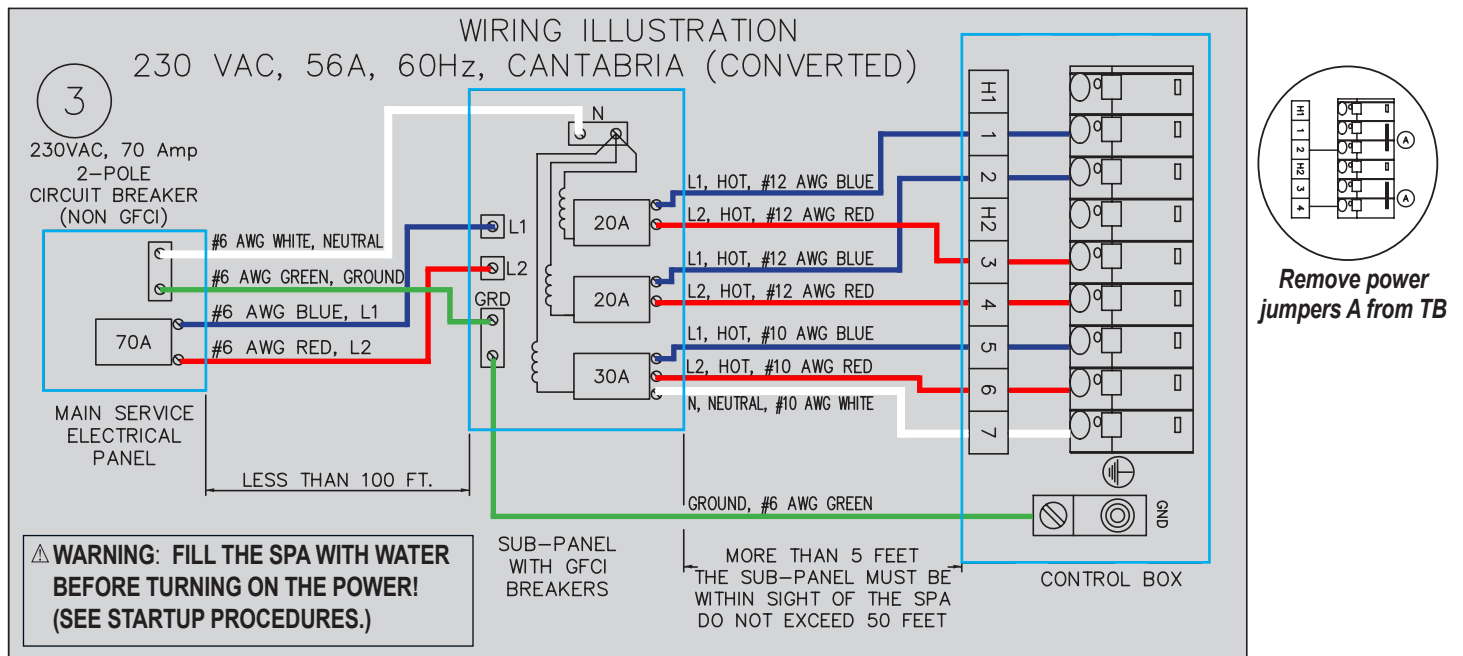

CAUTIONS

USE COPPER CONDUCTORS ONLY
USE SUPPLY WIRES SUITABLE FOR 75°C/167°F.
DISCONNECT ALL SUPPLY CONNECTIONS BEFORE SERVICING.
CONNECT ONLY TO A CIRCUIT PROTECTED BY A CLASS A GROUND-FAULT INTERRUPTER.

THESE SPAS ARE INTENDED FOR USE WITH GFCI SUBPANEL PROVIDED.
ALL CANADIAN SPA MODELS USE #8 AWG GREEN, GROUND.
INCORRECT WIRING WILL DAMAGE CIRCUIT BOARDS.
REFER TO THE WIRING INSTRUCTIONS INCLUDED WITH THE SUB-PANEL FOR DETAILED WIRING INSTRUCTIONS.

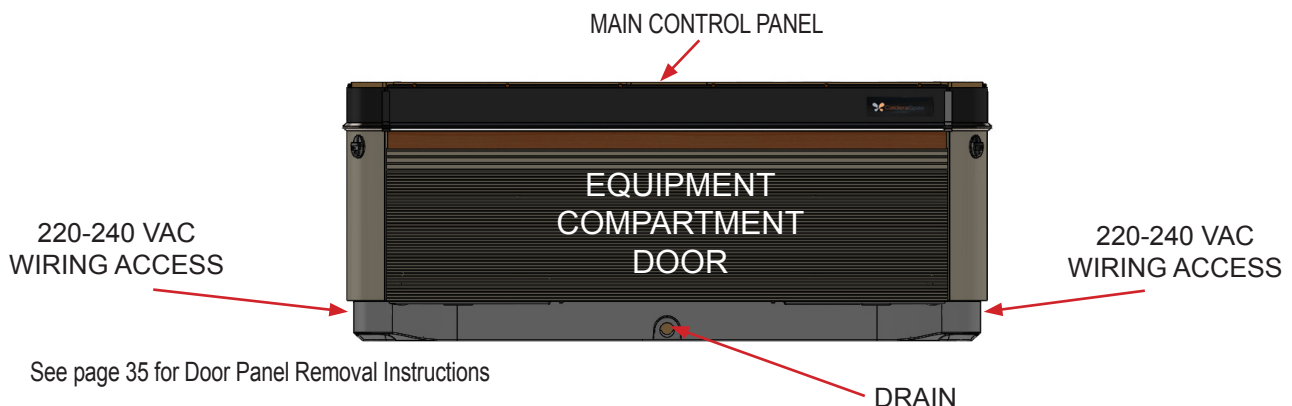

SERVICE INFORMATION

GENERAL INFORMATION

Your **CALDERA** spa has been designed to provide years of trouble-free use. As with any appliance, problems may occasionally occur that require the expertise of a qualified service person. Though such simple repairs as resetting a GFCI switch or breaker, or resetting a high limit thermostat may not require a service call, they may indicate that a more serious condition exists. These conditions may require an experienced service person. Before calling for service, please refer to the Troubleshooting Guide. Always retain your original sales receipt for future reference.

GFCI AND HIGH LIMIT THERMOSTAT

If your spa fails to operate at any time, first check the power supply to the spa.

Check each of the GFCI breakers in the subpanel. If a GFCI has tripped, reset it. If it will not reset, this may be an indication of a ground fault (short circuit) within the electrical components. Contact an Authorized Service Technician for a complete diagnosis.

If upon checking the GFCI's you find that they have not tripped, check the house breaker panel and ensure the main breaker for the electrical circuit supplying the spa has not tripped. If it has, this is an indication that the circuit was either overloaded or a ground fault exists between the breaker panel and the spa receptacle or subpanel. Contact a qualified electrician.

If upon checking the main house breaker and spa GFCI's you find no failures, check the high limit thermostat. To check it, simply turn off power to the spa for 30 seconds. This will automatically reset the high limit thermostat if it has tripped. If the spa energizes once you turn the power back on, this indicates reduced water flow through the heating system. Tripping of the high limit thermostat is normally a result of one or a combination of these problems. 1) clogged filter cartridge(s), 2) blockage within the system plumbing, 3) a non-functioning heater circulation pump, 4) power was not disconnected from the spa before it was drained, 5) an air lock in the plumbing lines. The Power Indicator on the front of the spa's control panel will also be blinking if the high limit thermostat circuit has tripped.

If the spa does not function after tripping and resetting the GFCI's or resetting the high limit thermostat, then the problem should be referred to an Authorized Service Technician. Refer to the Troubleshooting Guide for additional service information.

HEATER AND INTEGRATED PRESSURE SWITCH

WATKINS WELLNESS unconditionally warrants the heater against any failure that would require replacement. This warranty's duration is equal to the time period identified in the Heater Warranty. This warranty defines unconditional as warranty coverage without exception provided that the component has failed to operate properly within the spa's system. This means that conditions that would normally invalidate the limited warranty, such as water chemistry damage, do not apply to the heater.

It is important to note that the heater is protected by both the heater high limit thermostat circuit and the integrated pressure switch. The causes of heater high limit tripping are discussed in the previous section.

If the spa is not heating, the red and green lights are blinking, but the pump and light are operating, then the pressure switch may be

open. Opening of the pressure switch is normally a result of one or a combination of these problems:

1. A clogged filter cartridge
2. Blockage within the system plumbing
3. Power was not disconnected to the spa before it was drained
4. An air lock in the plumbing lines
5. Circulation pump not properly working

Once the problem has been identified and corrected the pressure switch will close which will energize the heater.

CIRCULATION PUMP AND CIRCULATION PUMP THERMAL CUT-OFF

The circulation pump is a dedicated, water cooled, energy efficient, quiet pump that provides continuous filtration for the spa. Since the pump is water cooled, it is equipped with a thermal cut-off to prevent the pump from being damaged by running hot when water is not present.

Reset the circulation pump's thermal cut-off by disconnecting power to the spa and allowing the pump to cool.

Tripping of the thermal cut-off is normally the result of one or a combination of these problems: 1) clogged filter cartridge(s), 2) blockage within the system plumbing, 3) power was not disconnected to the spa before it was drained, or 4) an air lock in the plumbing lines. Once the problem has been identified and corrected the pump thermal cut-off will be able to be reset which will allow it to operate normally.

MISCELLANEOUS SERVICE INFORMATION

The control and high-limit thermostats are equipped with electronic sensors that are connected to the spa's plumbing. Never cut or kink the wires that connect the sensors to the thermostats within the control box.

The jet pump is equipped with a thermal overload cutoff switch that is designed to protect the pump from overheating. If the pump shuts itself off in an older spa, it could indicate failure of the pump motor bearings. If the pump shuts itself off in a new spa, it is usually the result of one or a combination of the following factors:

- Thermal overload: Although mass-produced, not all thermal overload cutoffs are exactly the same. Some are more sensitive than others and will shut the pump off at lower temperatures.
- High temperature: All **CALDERA** spa models are equipped with a jet pump shroud that vents the heat generated by the pump motor to the outside of the equipment compartment, and back into the spa water. If the vent is blocked by masonry, grass or debris, overheating of the jet pump may occur. Once the pump motor has cooled sufficiently and any blockage has been removed from the vent opening, the jet pump can be restarted.
- Friction: Sometimes the moving parts of a new pump are tight enough to cause heat build-up due to friction. After a normal break-in period, the pump will run cooler.
- Improper wiring: If the spa is connected with an extension cord, and/or the house wiring is undersized, the pump may starve for voltage and therefore may draw more amperage and generate excessive heat.
- If the pump is shutting down due to excessive heat, make sure the equipment compartment has adequate ventilation. The air gap at the bottom must not be blocked. Should your jet pump continue to shut off after short periods of use, contact a qualified service technician.

ACTS INVALIDATING WARRANTY

The limited warranty is void if the **CALDERA** spa has been improperly installed, subjected to alteration, misuse, or abuse, or if any repairs on the spa are attempted by anyone other than an authorized representative of W atkins Manufacturing Corporation. Alteration shall include any component or plumbing change, electrical conversion, or the addition of any non-approved sanitation or water purification device or heating system which contributes to component or unit failure or unsafe operating system. Misuse and abuse shall include any operation of the spa other than in accordance with **WATKINS WELLNESS** printed instructions, or use of the spa in an application for which it is not designed; specifically: use of the spa in a non-residential application; damage caused by operation* of the spa at water temperatures outside the range of 35°F (1.5°C) and 120°F (49°C); damage caused by a dirty, clogged or calcified filter cartridge; damage to the spa surface caused by the use of tri-chloro chlorine, BCDMH, misuse of chemical tablets in a floater, acid, or any other spa chemicals or spa surface cleaners which are not recommended by **WATKINS WELLNESS**; damage caused by allowing undissolved spa sanitizing chemicals to lie on the spa surface (no spa surface material can withstand this kind of abuse); damage to components or spa surface caused by improper water chemistry maintenance; and damage to the spa surface caused by leaving the spa uncovered while empty of water and in direct exposure to sunlight (this may cause solar heating distress in warm weather regions). These are considered abuses and may invalidate this warranty.

*Operation of the spa **does not** mean “use” of the spa! **WATKINS WELLNESS** does not recommend using the spa if the water temperature is above or below the spa’s control panel temperature range.

DISCLAIMERS

WATKINS WELLNESS shall not be liable for loss of use of the **CALDERA** spa, or other incidental, consequential, special, indirect, or punitive costs, expenses or damages, which may include but are not limited to the removal of a permanent deck or other custom fixture, or the necessity for crane removal. Any implied warranty shall have a duration equal to the duration of the applicable limited warranty stated above. Some states do not allow limitations on how long an implied warranty lasts. Under no circumstances shall **WATKINS WELLNESS** or any of its representatives be held liable for injury to any person or damage to any property, however arising.

Some states do not allow the exclusion or limitation of incidental or consequential damages, so the above limitations may not apply to you.

WATKINS CUSTOMER SERVICE

If you have any questions about any aspect of your **CALDERA** spa set-up, operation or maintenance that have not been answered by this manual, consult your **CALDERA** dealer.

WATKINS WELLNESS can be reached at: 800-669-1881 (Extension 8432), Monday through Friday, 8 am to 5-pm Pacific Standard Time (PST), or e-mail customerservice@watkinsmfg.com.

TROUBLESHOOTING

Should you experience any problem whatsoever, do not hesitate to contact your authorized **CALDERA** dealer. Located below and on the next page are some tips to help you to diagnose and rectify some more common sources of trouble yourself, if you choose to do so.

SPA WATER MAINTENANCE TROUBLESHOOTING GUIDE

Problem	Probable causes	Solutions
Cloudy Water	<ul style="list-style-type: none"> • Dirty filters • Excessive oils / organic matter • Improper sanitization • Suspended particles / organic matter • Overused or old water 	<ul style="list-style-type: none"> • Clean filters • Shock spa with sanitizer • Add sanitizer • Adjust pH and/or alkalinity to recommended range • Run jet pump(s) and clean filters • Drain and refill the spa
Water Odor	<ul style="list-style-type: none"> • Excessive organics in water • Improper sanitization • Low pH 	<ul style="list-style-type: none"> • Shock spa with sanitizer • Add sanitizer • Adjust pH to recommended range
Chlorine Odor	<ul style="list-style-type: none"> • Chloramine level too high • Low pH 	<ul style="list-style-type: none"> • Shock spa with sanitizer • Adjust pH to recommended range
Musty Odor	<ul style="list-style-type: none"> • Bacteria or algae growth 	<ul style="list-style-type: none"> • Shock spa with sanitizer—if problem is visible or persistent, drain, clean and refill the spa
Organic buildup / scum ring around spa	<ul style="list-style-type: none"> • Build-up of oils and dirt 	<ul style="list-style-type: none"> • Wipe off scum with clean rag – if severe, drain the spa, use a spa surface and tile cleaner to remove the scum, and refill the spa
Algae Growth	<ul style="list-style-type: none"> • High pH • Low sanitizer level 	<ul style="list-style-type: none"> • Shock spa with sanitizer and adjust pH • Shock spa with sanitizer and maintain sanitizer level
Eye Irritation	<ul style="list-style-type: none"> • Low pH • Low sanitizer level 	<ul style="list-style-type: none"> • Adjust pH • Shock spa with sanitizer and maintain sanitizer level
Skin Irritation / Rash	<ul style="list-style-type: none"> • Unsanitary water • Free chlorine level above 5 ppm 	<ul style="list-style-type: none"> • Shock spa with sanitizer and maintain sanitizer level • Allow free chlorine level to drop below 5 ppm before spa use
Stains	<ul style="list-style-type: none"> • Total alkalinity and/or pH too low • High iron or copper in source water 	<ul style="list-style-type: none"> • Adjust total alkalinity and/or pH • Use a metal deposit inhibitor
Scale	<ul style="list-style-type: none"> • High calcium content in water – total alkalinity and pH too high 	<ul style="list-style-type: none"> • Adjust total alkalinity and pH – if scale requires removal, drain the spa, scrub off the scale, refill the spa and balance the water

GENERAL OPERATION TROUBLESHOOTING GUIDE

Problem	Probable causes	Solutions
Entire spa is inoperative	<ul style="list-style-type: none"> Power failure GFCI tripped Heater high-limit thermostat tripped 	<ul style="list-style-type: none"> Check power source. Reset GFCI; call for service if it will not reset. Disconnect power for at least thirty seconds to reset heater high limit. If it will not reset, check for clogged filters. If tripping continues, call for service. Deactivate spa lock.
Spa does not heat; jets and light operate (Orange logo "Ready", and Gray logo "Power" indicators are blinking)	<ul style="list-style-type: none"> Integrated pressure switch open Circulation pump thermal cut-off tripped 	<ul style="list-style-type: none"> Check for clogged filters. Integrated pressure switch will reset when the flow of water through the heater has been restored. Call for service if the heater trips frequently. Check for clogged filters or air locks in plumbing. Disconnect power to the spa, allow circulation pump to cool. Circulation pump thermal cut-off will reset when pump has cooled and power is reapplied. Call for service if circulation pump thermal cut-off trips frequently.
Jets weak or surging	<ul style="list-style-type: none"> Spa water level too low Filters clogged Air valves are closed 	<ul style="list-style-type: none"> Add water. Clean filters. Open air valves .
Lights inoperative	<ul style="list-style-type: none"> Spa lock activated Light wiring or assembly is faulty 	<ul style="list-style-type: none"> Deactivate spa lock Call for service, replace light assembly
Spa not heating properly	<ul style="list-style-type: none"> Temperature set too low Spa cover improperly positioned Dirty Filter Summer Timer On 	<ul style="list-style-type: none"> Set control panel to a higher temperature. Align spa cover. Clean filter. Turn summer timer mode to off position.
Gray Logo "Power" indicator blinking	<ul style="list-style-type: none"> Heater high-limit thermostat tripped 	<ul style="list-style-type: none"> Disconnect power for at least thirty seconds to reset heater high limit. If it will not reset, check for clogged filters. If tripping continues, call for service.
Orange Logo "Ready" indicator blinking	<ul style="list-style-type: none"> Temperature sensor problem 	<ul style="list-style-type: none"> Disconnect power for at least thirty seconds. If blinking continues, call for service.
Orange Logo "Ready" indicator flashing On 1 second and Off 3 seconds	<ul style="list-style-type: none"> Salt system issue 	<p>Go to the Salt System menu on the control panel. Based on the Error Code displayed, follow the instructions below:</p> <ul style="list-style-type: none"> Error Code 5 <ol style="list-style-type: none"> Using a FreshWater Salt test strip, verify that salt levels are at 1750 ppm. Add salt, per salt system instructions as necessary. Power down the spa, remove salt system housing cap and verify that a salt cartridge is installed in the housing. Contact your local Dealer if neither a. or b. resolves the problem. Error Code 4 <ol style="list-style-type: none"> Power down the spa, remove the salt system housing cap and remove the salt system cartridge. Inspect the cartridge for damage. If damage is found the cartridge should be replaced. Using a FreshWater Salt test strip, verify the salt level. If the salt level is above 2500 ppm this may be the problem. If the salt level is above 2500 you will now need to determine how much above 2500 ppm the salt level is by following the steps below: <ol style="list-style-type: none"> Use a clean container and fill with eight (8) ounces (0.25 liter) of water from the spa Remove four (4) ounces (0.125 liter) of the spa water from the container Then add four (4) ounces (0.125 liter) of water from your household tap and mix to combine Using a new FreshWater Salt test strip, confirm the salt level of this new mixture of spa and tap water <ol style="list-style-type: none"> If the salt level is still at or above 2500 ppm, power down the spa, drain and refill the spa with new water and follow the salt system start up instructions ensuring that salt level is at 1750 ppm If the salt level is below 2500 ppm, the amount of salt in the spa is not causing the error – contact your local Dealer for assistance Contact your local Dealer if neither a. or b. resolves the problem.
Pump motor will not function	<ul style="list-style-type: none"> Motor overload condition Control switch failure if jet symbol does not come on 	<ul style="list-style-type: none"> Let cool for one hour. Motor overload will reset automatically. If problem persists, contact your CALDERA dealer. Disconnect spa and contact your CALDERA dealer.
Noisy pump or motor	<ul style="list-style-type: none"> Low water level 	<ul style="list-style-type: none"> Add water to normal level (1 inch or 2.5 cm above highest jet)
Pump motor runs, but low or no water/ jet pressure	<ul style="list-style-type: none"> Air control valve closed or blocked Low water level Dirty filter cartridge Jet blocked Clogged suction or skimmer basket 	<ul style="list-style-type: none"> Open or clean air valve. Add water to normal level (1 inch or 2.5 cm above highest jet). Clean filter cartridge. Remove jet face eyeball and clean orifice. Clean suction cover or skimmer basket.
Diverter valves are difficult to turn	<ul style="list-style-type: none"> Sand or grit inside valves 	<ul style="list-style-type: none"> Clean and lubricate valve per diverter valve maintenance instructions.
After filling or refilling the spa: a jet pump is operating, but water is not flowing from any of its jets	<ul style="list-style-type: none"> Pump is not properly primed 	<ul style="list-style-type: none"> Turn off power to the spa at the breaker and remove the equipment compartment door. Loosen the union on the top of the pump(s) to allow the air to escape, and then hand-tighten the union(s). Turn power back on, activate the pump, and check to make sure the union is tight enough to keep it from leaking. Replace the equipment doors.

DOOR PANEL REMOVAL

The illustrations are to be used as a reference only (your spa may look different).

- 1 Locate the two buttons below the front panel.

Push up and hold one of the buttons using a #2 stubby screwdriver or an Allen wrench less than 1/4" (6 mm) in width into the center of the safety lock then pull the door panel away from the spa next to that button location to completely disengage the bottom clip. Repeat procedure on second button.

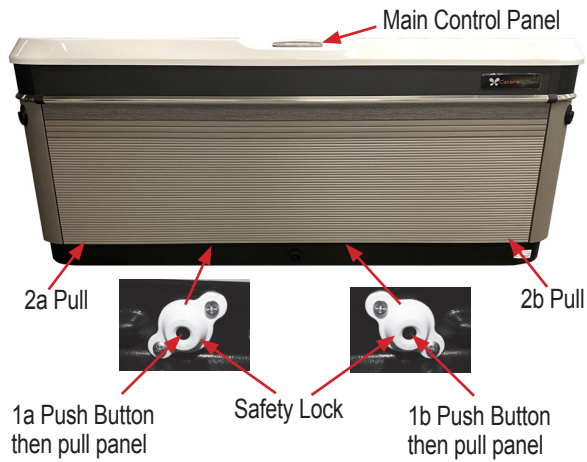

- 2 Pull (with slight force) on bottom left corner until panel un-clips followed by the right corner until panel un-clips.

- 3 Pull bottom door panel away (using both hands spaced shoulder length apart) from each side of the spa center, this may require a slight amount of force because of the upper clips, this may require a slight amount of force because of the upper clips until they all un-clip. Lower panel to ground. Disconnect both the logo light and front light wires from door panel, then remove door panel from spa area and set in a cool shaded place. Remove foam to access.

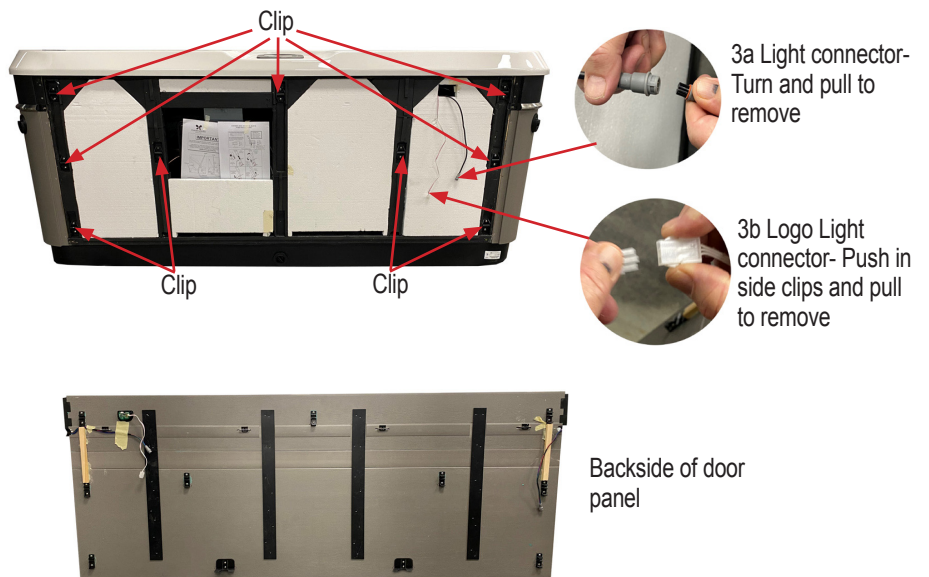

DOOR PANEL REPLACEMENT

- 1 Set door panel in front of equipment compartment and connect the logo light and front light wires. Raise door panel placing top under shell with bottom slightly away from spa.

- 2 Raise door panel under bar top. Place door panel against spa allowing door clips 1 & 2 to rest above the wood frame as seen below. Push door clip half way into spa clip.

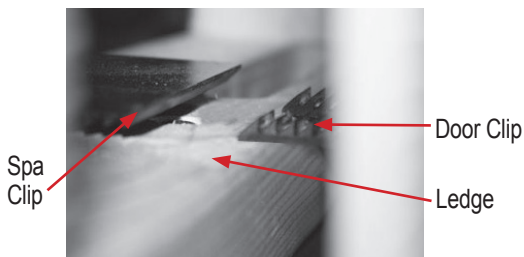

- 3 Slide door panel from side to side allowing the spacing to be even on both sides of the door.

Align metal trim on right side then push the door panel clips into the spa frame (3,4 5), repeat on left side (6,7,8) followed by 9,10,11.

NOTE: Push in any areas that may look like they have not been clipped in.

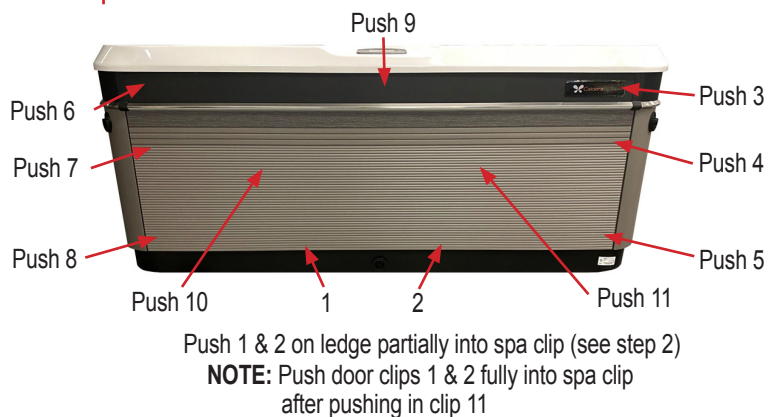

UTOPIA SPECIFICATIONS

This manual contains installation, operating, maintenance, and service information for the following CALDERA spa

	Footprint dimensions	Height	Effective filter area	Heater (Watts)	Water capacity	Dry weight	Filled weight*	Dead weight	Electrical Requirements
CANTABRIA 8 Person	7'7" x 9'0" 231 cm x 274 cm	38" 97 cm	100 ft ² 9 m ²	4,000	615 gallons 2,325 liters	1,310 lbs 595 kg	7,840 lbs 3,560 kg	130 lbs/ft ² 680 kg/m ²	230 volt, 20A & 30A or 230 volt 20A, 20A & 30A Single phase GFCI protected circuits
GENEVA 6 Person	7'5" x 7'5" 226 cm x 226 cm	38" 97 cm	100 ft ² 9 m ²	4,000	410 gallons 1,550 liters	1000 lbs 455 kg	5,470 lbs 2,485 kg	120 lbs/ft ² 590 kg/m ²	230 volt, 30A or 230 volt 20A & 30A Single phase GFCI protected circuits
NIAGARA 7 Person	7'5" x 7'5" 226 cm x 226 cm	38" 97 cm	100 ft ² 9 m ²	4,000	400 gallons 1,525 liters	995 lbs 450 kg	5,555 lbs 2,535 kg	122 lbs/ft ² 600 kg/m ²	230 volt, 30A or 230 volt 20A & 30A Single phase GFCI protected circuits
TAHITIAN 6 Person	7'0" x 7'0" 213 cm x 213 cm	36" 91 cm	100 ft ² 9 m ²	4,000	375 gallons 1,425 liters	900 lbs 410 kg	5,080 lbs 2,315 kg	125 lbs/ft ² 610 kg/m ²	230 volt, 30A or 230 volt 20A & 30A Single phase GFCI protected circuits
FLORENCE 6 Person	7'0" x 7'0" 213 cm x 213 cm	36" 91 cm	100 ft ² 9 m ²	4,000	360 gallons 1,362 liters	872 lbs 395 kg	4,925 lbs 2,235 kg	120 lbs/ft ² 585 kg/m ²	230 volt, 30A or 230 volt 20A & 30A Single phase GFCI protected circuits
RAVELLO 3 Person	7'0" x 5'6" 213 cm x 168 cm	33" 84 cm	50 ft ² 5 m ²	3,000	265 gallons 1,025 liters	720 lbs 325 kg	3,460 lbs 1,590 kg	115 lbs/ft ² 570 kg/m ²	230 volt, 30A or 230 volt 20A & 30A Single phase GFCI protected circuits

CAUTION: **WATKINS WELLNESS** suggests a structural engineer or contractor be consulted before the spa is placed on an elevated deck.

* NOTE: The "Filled weight" and "Dead weight" of the spa includes the weight of the occupants (assuming an average occupant weight of 175 lbs (80 kg)). For 30 amp or 70 amp conversion contact your local dealer.

©2023 **WATKINS WELLNESS**. CALDERA SPAS, UTOPIA, FRESHWATER, ACQUARELLA, ADAPTAFL0, ADAPTASSAGE, ADVENT, ENERGYPRO, SPAGLO, CANTABRIA, GENEVA, NIAGARA, TAHITIAN, FLORENCE, RAVELLO, AVANTE, ECSTASEAT, EURO-PULSE, VERSASSAGE, ORBISSAGE, LUMBARSSAGE, SOLE SOOTHERS, EUPHORIA, ULTRAMASSAGE, AND ULTRAMASSEUSE, ARE TRADEMARKS OF **WATKINS WELLNESS**. BAQUASPA IS A TRADEMARK OF Arch UK Biocides Limited, Inc. SOFT SCRUB IS A TRADEMARK OF HENKEL CONSUMER GOODS, INC. BRILLIANIZE IS A TRADEMARK OF BRILLIANIZE, INC. SIMPLE GREEN IS A TRADEMARK OF SUNSHINE MAKERS, INC. WINDEX IS A TRADEMAKE OF S.C. JOHNSON & SON, INC.



WatkinsWellness[®]

Feel good. Live well.

Vista, California
USA

calderaspas.com



303763,24



303763.24 A (12/23)